

POLITICS
among NATIONS

THE STRUGGLE FOR POWER
AND PEACE

by

Hans J. Morgenthau

ASSOCIATE PROFESSOR OF POLITICAL SCIENCE
THE UNIVERSITY OF CHICAGO

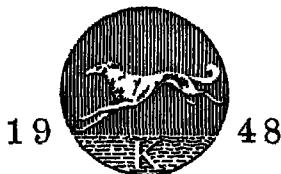

NEW YORK :: ALFRED A. KNOFF

THIS IS A BORZOI BOOK,
PUBLISHED BY ALFRED A. KNOPF, INC.

COPYRIGHT 1948 by Alfred A. Knopf, Inc. All rights reserved. No part of this book in excess of five hundred words may be reproduced in any form without permission in writing from the publisher, except by a reviewer who may quote brief passages in a review to be printed in a magazine or newspaper. Manufactured in the United States of America. Published simultaneously in Canada by The Ryerson Press.

FIRST EDITION

TO

the memory of my father

FOREWORD

This book developed from lectures in international politics which I have given at the University of Chicago since 1943. Though it covers the traditional subject matter of courses in international relations, special emphasis is placed on basic problems of international law, international organization, and diplomatic history.

I owe a great debt of gratitude to my students. Their lively class discussions contributed to the clarification of my own thinking on the problems discussed in this book. Among my students who rendered special services to make this book possible I must mention a few. Miss Mary Jane Beneditz made a stenographic transcript of the lectures given in the Winter Quarter of 1946 as well as of the class discussions. Her intelligent and painstaking labor made available the only written record of those lectures; without that record the book could not have been completed in little more than a year. Mr. Alfred Hotz assisted me ably in the research in the initial stages of the work. The main burden of assistance, however, fell upon Mr. Kenneth W. Thompson, who brought to his task an extraordinary measure of ability and devotion. The original versions of the maps were drafted by Mr. Charles R. Jones and those of the diagrams were drawn by Mr. John Horton.

I am deeply grateful to Professor Leonard D. White who, as administrative head of the Political Science Department of the University of Chicago, gave me every possible assistance; his understanding greatly facilitated my work. Professors Waldemar Gurian of the University of Notre Dame and Edward A. Shils of the University of Chicago and the London School of Economics and Political Science read the manuscript and gave me the benefit of their advice and criticism. Many of my colleagues advised me on special points. For whatever merit there is in the title of this book, Professor Charles M. Hardin must take all the credit since I chose it upon his suggestion. The Social Science Research Committee of the University of Chicago contributed generous financial support to the work and a long succession of members of the clerical staff of the Social Science Research Committee rendered competent assistance. I acknowledge the services of all with gratitude.

The following publishers and publications have been kind enough to grant permission to incorporate in the book material published previously: *American Journal of International Law*, *Columbia Law Review*, *Ethics*, *Review of Politics*, University of Chicago Press, and the *Yale Law Journal*.

HANS J. MORGENTHAU

Chicago, Illinois

CONTENTS

PART ONE

INTERNATIONAL POLITICS: A DUAL APPROACH

1. UNDERSTANDING INTERNATIONAL POLITICS	3
2. UNDERSTANDING THE PROBLEM OF INTERNATIONAL PEACE	7

PART TWO

INTERNATIONAL POLITICS AS A STRUGGLE FOR POWER

I · <i>Political Power</i>	13
1. WHAT IS POLITICAL POWER?	13
2. THE DEPRECIATION OF POLITICAL POWER	15
3. TWO ROOTS OF THE DEPRECIATION OF POLITICAL POWER	18
II · <i>The Struggle for Power: Policy of the Status Quo</i>	21
III · <i>The Struggle for Power: Imperialism</i>	26
1. WHAT IMPERIALISM IS NOT	26
2. ECONOMIC THEORIES OF IMPERIALISM	29
a) The Marxian, Liberal, and "Devil" Theories of Imperialism	29
b) Criticism of these Theories	31
3. DIFFERENT TYPES OF IMPERIALISM	34
a) Three Inducements to Imperialism	34
b) Three Goals of Imperialism	36
c) Three Methods of Imperialism	38
Military Imperialism	38
Economic Imperialism	39
Cultural Imperialism	40
4. HOW TO DETECT AND COUNTER AN IMPERIALISTIC POLICY	43
a) Appeasement	43
b) Fear	45
c) Five Difficulties of the Problem	46
IV · <i>The Struggle for Power: Policy of Prestige</i>	50
1. DIPLOMATIC CEREMONIAL	51
2. DISPLAY OF MILITARY FORCE	54
3. TWO OBJECTIVES OF THE POLICY OF PRESTIGE	55
4. TWO CORRUPTIONS OF THE POLICY OF PRESTIGE	58

Contents

v · <i>Ideological Element in International Policies</i>	61
1. THE NATURE OF POLITICAL IDEOLOGIES	61
2. TYPICAL IDEOLOGIES OF INTERNATIONAL POLICIES	63
a) Ideologies of the Status Quo	63
b) Ideologies of Imperialism	64
c) Ambiguous Ideologies	67
3. THE PROBLEM OF RECOGNITION	68

PART THREE

NATIONAL POWER

vi · <i>The Essence of National Power</i>	73
1. WHAT IS NATIONAL POWER?	73
2. ROOTS OF MODERN NATIONALISM	76
vii · <i>Elements of National Power</i>	80
1. GEOGRAPHY	80
2. NATURAL RESOURCES	82
3. INDUSTRIAL CAPACITY	86
4. MILITARY PREPAREDNESS	88
5. POPULATION	91
6. NATIONAL CHARACTER	96
7. NATIONAL MORALE	100
8. THE QUALITY OF DIPLOMACY	105
viii · <i>Evaluation of National Power</i>	109
1. THE TASK OF EVALUATION	109
2. TYPICAL ERRORS OF EVALUATION	112
a) The Absolute Character of Power	112
b) The Permanent Character of Power	114
c) The Fallacy of the Single Factor	116
Geopolitics	116
Nationalism	118
Militarism	120

PART FOUR

LIMITATIONS OF INTERNATIONAL POWER:

① THE BALANCE OF POWER

ix · <i>The Balance of Power</i>	125
1. SOCIAL EQUILIBRIUM	125
2. TWO MAIN PATTERNS OF THE BALANCE OF POWER	129

x · <i>Different Methods of the Balance of Power</i>	134
1. DIVIDE AND RULE	134
2. COMPENSATIONS	135
3. ARMAMENTS	136
4. ALLIANCES	137
a) Alliances vs. World Domination	137
b) Alliances vs. Counteralliances	138
5. THE "HOLDER" OF THE BALANCE	142
xI · <i>The Structure of the Balance of Power</i>	146
1. DOMINANT AND DEPENDENT SYSTEMS	146
2. STRUCTURAL CHANGES IN THE BALANCE OF POWER	148
xII · <i>Evaluation of the Balance of Power</i>	150
1. THE UNCERTAINTY OF THE BALANCE OF POWER	151
2. THE UNREALITY OF THE BALANCE OF POWER	155
a) The Balance of Power as Ideology	157
3. THE INADEQUACY OF THE BALANCE OF POWER	159
a) Restraining Influence of a Moral Consensus	160
b) Moral Consensus of the Modern State System	162

PART FIVE

LIMITATIONS OF INTERNATIONAL POWER:
INTERNATIONAL MORALITY AND
WORLD PUBLIC OPINION

xIII · <i>Ethics, Mores, and Law as Restraints on Power</i>	169
xIV · <i>International Morality</i>	174
1. THE PROTECTION OF HUMAN LIFE	175
a) Protection of Human Life in Peace	175
b) Protection of Human Life in War	178
c) Moral Condemnation of War	180
d) International Morality and Total War	181
2. UNIVERSAL MORALITY VS. NATIONALISTIC UNIVERSALISM	184
a) Personal Ethics of the Aristocratic International	184
b) Destruction of International Morality	187
c) Destruction of International Society	189
d) Victory of Nationalism over Internationalism	191
e) Transformation of Nationalism	192
xV · <i>World Public Opinion</i>	197
1. PSYCHOLOGICAL UNITY OF THE WORLD	199
2. AMBIGUITY OF TECHNOLOGICAL UNIFICATION	200
3. THE BARRIER OF NATIONALISM	202

Contents

PART SIX

LIMITATIONS OF INTERNATIONAL POWER:
⑦ INTERNATIONAL LAW

xvi · <i>The Main Problems of International Law</i>	209
1. THE GENERAL NATURE OF INTERNATIONAL LAW	209
2. THE LEGISLATIVE FUNCTION IN INTERNATIONAL LAW	211
a) Its Decentralized Character	211
b) The Problem of Codification	214
c) Interpretation and Binding Force	216
3. THE JUDICIAL FUNCTION IN INTERNATIONAL LAW	219
a) Compulsory Jurisdiction	220
The Optional Clause	221
b) International Courts	224
c) The Effect of Judicial Decisions	226
4. THE ENFORCEMENT OF INTERNATIONAL LAW	228
a) Its Decentralized Character	228
b) Treaties of Guaranty	230
c) Collective Security	232
Article 16 of the Covenant of the League of Nations	232
Chapter VII of the Charter of the United Nations	236
The Veto	239
xvii · <i>Sovereignty</i>	243
1. THE GENERAL NATURE OF SOVEREIGNTY	243
2. SYNONYMS OF SOVEREIGNTY: INDEPENDENCE, EQUALITY, UNANIMITY	245
3. WHAT SOVEREIGNTY IS NOT	247
4. HOW SOVEREIGNTY IS LOST	249
a) The United States Proposal for International Control of Atomic Energy	252
b) Majority Vote in International Organizations	255
5. IS SOVEREIGNTY DIVISIBLE?	258

PART SEVEN

WORLD POLITICS IN THE MID-TWENTIETH
CENTURY

xviii · <i>The New Moral Force of Nationalistic Universalism</i>	267
xix · <i>The New Balance of Power</i>	270
1. INFLEXIBILITY OF THE NEW BALANCE OF POWER	270
2. DISAPPEARANCE OF THE BALANCER	273

Contents

3. DISAPPEARANCE OF THE COLONIAL FRONTIER	278
4. POTENTIALITIES OF THE TWO-BLOC SYSTEM	284
XX · <i>Total War</i>	287
1. WAR OF TOTAL POPULATIONS	280
2. WAR BY TOTAL POPULATIONS	292
3. WAR AGAINST TOTAL POPULATIONS	293
4. THE MECHANIZATION OF WARFARE	294
5. WAR FOR TOTAL STAKES	298
6. TOTAL MECHANIZATION, TOTAL WAR, AND TOTAL DOMINION	301

PART EIGHT

THE PROBLEM OF PEACE IN THE MID-TWENTIETH CENTURY: PEACE THROUGH LIMITATION

XXI · <i>Disarmament</i>	309
1. THE PROBLEM OF PEACE IN OUR TIME	309
2. HISTORY OF DISARMAMENT	311
3. FOUR PROBLEMS OF DISARMAMENT	314
a) The Ratio	314
The Rush-Bagot Agreement, the Washington Treaty, and the Anglo-German Naval Agreement	315
The World Disarmament Conference and the United Nations Commissions	317
b) Standards of Allocation	321
c) Does Disarmament Mean Reduction of Armaments?	324
d) Does Disarmament Mean Peace?	326
XXII · <i>Security</i>	331
1. COLLECTIVE SECURITY	331
a) The Italo-Ethiopian War	336
2. AN INTERNATIONAL POLICE FORCE	337
XXIII · <i>Judicial Settlement</i>	341
1. THE NATURE OF THE JUDICIAL FUNCTION	341
2. THE NATURE OF INTERNATIONAL CONFLICTS: TENSIONS AND DISPUTES	343
a) Pure Disputes	344
b) Disputes with the Substance of a Tension	344
c) Disputes Representing a Tension	345
3. LIMITATIONS OF THE JUDICIAL FUNCTION	346

Contents

XXIV · <i>Peaceful Change</i>	350
1. PEACEFUL CHANGE WITHIN THE STATE	350
2. PEACEFUL CHANGE IN INTERNATIONAL AFFAIRS	353
a) Article 19 of the Covenant of the League of Nations	355
b) The Palestine Resolution of the General Assembly of the United Nations	356
XXV · <i>International Government</i>	361
1. THE HOLY ALLIANCE	361
a) History	361
b) Government by the Great Powers	363
c) Dual Meaning of the Status Quo	363
d) Peace, Order, and the National Interest	365
e) The Concert of Europe	367
2. THE LEAGUE OF NATIONS	368
a) Organization	369
b) Dual Meaning of the Status Quo: France vs. Great Britain	371
c) Three Weaknesses of the League of Nations	373
Constitutional Weakness	374
Structural Weakness	375
Political Weakness	377
3. THE UNITED NATIONS	379
a) Government by Superpowers	379
b) Undefined Principles of Justice	382
c) The Undefined Status Quo: the Soviet Union vs. the United States	383
Provisional Character of the Status Quo	384
Instability of the Status Quo	385

PART NINE

THE PROBLEM OF PEACE IN THE MID-TWENTIETH CENTURY: PEACE THROUGH TRANSFORMATION

XXVI · <i>The World State</i>	391
1. CONDITIONS OF DOMESTIC PEACE	392
a) Suprasectional Loyalties	392
b) Expectation of Justice	394
c) Overwhelming Power	395
d) The Role of the State	396
2. THE PROBLEM OF THE WORLD STATE	398
3. TWO FALSE SOLUTIONS	402
a) World Conquest	403
b) The Examples of Switzerland and the United States	404

Contents

xxvii · <i>The World Community</i>	407
1. THE CULTURAL APPROACH: UNESCO	407
2. THE FUNCTIONAL APPROACH: THE SPECIALIZED AGENCIES OF THE UNITED NATIONS	412

PART TEN

THE PROBLEM OF PEACE IN THE
MID-TWENTIETH CENTURY:
PEACE THROUGH ACCOMMODATION

xxviii · <i>Diplomacy</i>	419
1. FOUR TASKS OF DIPLOMACY	419
2. INSTRUMENTS OF DIPLOMACY	421
a) Symbolic Representation	422
b) Legal Representation	423
c) Political Representation	423
3. THE DECLINE OF DIPLOMACY	425
a) Development of Communications	425
b) Depreciation of Diplomacy	426
c) Diplomacy by Parliamentary Procedures	427
d) The Superpowers: Newcomers in Diplomacy	428
e) The Nature of Contemporary World Politics	430
xxix · <i>The Future of Diplomacy</i>	431
1. HOW CAN DIPLOMACY BE REVIVED?	431
a) The Vice of Publicity	431
b) The Vice of Majority Decision	433
c) The Vice of Fragmentation	435
2. THE PROMISE OF DIPLOMACY: ITS EIGHT RULES	438
a) Four Fundamental Rules	439
b) Four Prerequisites of Compromise	441
3. CONCLUSION	443

APPENDIX. <i>Charter of the United Nations</i>	449
--	-----

BIBLIOGRAPHY	473
--------------	-----

INDEX	<i>follows page 489</i>
-------	-------------------------

MAPS

<i>The World</i>	2
<i>Uranium Deposits</i>	85
<i>Probable Population Increases in Next Two Decades</i>	95
<i>The Natural Seats of Power</i>	117
<i>The Balance of Power in the Eighteenth Century</i>	276
<i>The Balance of Power in the Mid-Twentieth Century</i>	277
<i>Main Issues of World Politics 1870-1914</i>	280
<i>Main Issues of World Politics in the Mid-Twentieth Century</i>	281
<i>Colonial Areas</i>	283

PART ONE

INTERNATIONAL POLITICS:
A DUAL APPROACH

International Politics:

A Dual Approach

I. UNDERSTANDING INTERNATIONAL POLITICS

The purpose of this book is twofold. The first is to detect and understand the forces which determine political relations among nations, and to comprehend the ways in which those forces act upon each other and upon international political relations and institutions. In most other branches of the social sciences there would be no need to emphasize this purpose. It would be taken for granted, because the natural purpose of all scientific undertakings is to discover the forces underlying social phenomena and how they operate. However, in approaching the study of international politics, such emphasis is not misplaced. As Professor Grayson Kirk has so ably said:

Until recent times the study of international relations in the United States has been dominated largely by persons who have taken one of three approaches. First there have been the historians who have considered international relations merely as recent history, in which the student is handicapped by the absence of an adequate amount of available data. A second group, the international lawyers, have properly concerned themselves primarily with the legal aspects of inter-state relations, but they have seldom made a serious effort to inquire into the fundamental reasons for the continuing incompleteness and inadequacy of this legal nexus. Finally, there have been those who have been less concerned with international relations as they are than with the more perfect system which these idealists would like to build. Only recently—and belatedly—have students undertaken to examine the fundamental and persistent forces of world politics, and the institutions which embody them, not with a view to praise or to condemn, but merely in an effort to provide a better understanding of these basic drives which determine the foreign policies of states. Thus the political scientist is moving into the international field at last.¹

Professor Charles E. Martin has taken up Professor Kirk's theme by pointing to "the problem which faces the students and the teachers of international relations more than any other, namely, that dualism we have to face in mov-

¹ *American Journal of International Law*, XXXIX (1945), 369-70.

Politics among Nations

ing in two different and opposite areas. I mean the area of institutions of peace which are related to the adjustment of disputes and the area of power politics and war. Yet, it must be so. There is no escape from it. . . . I think probably one of the greatest indictments of our attitude in teaching in the last twenty years has been to write off glibly the institution of war and to write off the books the influence of power politics. I think political scientists make a great mistake in doing so. We should be the very ones who are studying power politics and its implications and the situations growing out of it, and we should be the ones who study the institution of war."²

Defined in such terms, international politics embraces more than recent history and current events. The observer is surrounded by the contemporary scene with its ever shifting emphasis and changing perspectives. He cannot find solid ground on which to stand, nor objective standards of evaluation, without getting down to fundamentals which are revealed only by the correlation of recent events with the more distant past.

International politics cannot be reduced to legal rules and institutions. International politics operates within the framework of such rules and through the instrumentality of such institutions. But it is no more identical with them than American politics on the national level is identical with the American Constitution, the federal laws, and the agencies of the federal government.

Concerning attempts to reform international politics before making an effort to understand what international politics is about, we share William Graham Sumner's view:

. . . The worst vice in political discussions is that dogmatism which takes its stand on great principles or assumptions, instead of standing on an exact examination of things as they are and human nature as it is. . . . An ideal is formed of some higher or better state of things than now exists, and almost unconsciously the ideal is assumed as already existing and made the basis of speculations which have no root. . . . The whole method of abstract speculation on political topics is vicious. It is popular because it is easy; it is easier to imagine a new world than to learn to know this one; it is easier to embark on speculations based on a few broad assumptions than it is to study the history of states and institutions; it is easier to catch up a popular dogma than it is to analyze it to see whether it is true or not. All this leads to confusion, to the admission of phrases and platitudes, to much disputing but little gain in the prosperity of nations.³

The most formidable difficulty facing a scientific inquiry into the nature and ways of international politics is the ambiguity of the material with which the observer has to deal. The events which he must try to understand are, on the one hand, unique occurrences. They happened in this way only once and never before or since. On the other hand, they are similar, for they are manifestations of social forces. Social forces are the product of human nature in action. Therefore, under similar conditions, they will manifest them-

² *Proceedings of the Eighth Conference of Teachers of International Law and Related Subjects* (Washington: Carnegie Endowment for International Peace, 1946), p. 66.

³ "Democracy and Responsible Government," *The Challenge of Facts and Other Essays* (New Haven: Yale University Press, 1914), pp. 245-6.

International Politics: A Dual Approach

selves in a similar manner. But where is the line to be drawn between the similar and the unique?

We learn what the principles of international politics are from comparisons between such events. A certain political situation evokes the formulation and execution of a certain foreign policy. Dealing with a different political situation, we ask ourselves: How does this situation differ from the preceding one and how is it similar? Do the similarities reaffirm the policy developed previously? Or does the blending of similarities and differences allow the essence of that policy to be retained while, in some aspects, it is to be modified? Or do the differences vitiate the analogy altogether and make the previous policy inapplicable? If one wants to understand international politics, grasp the meaning of contemporary events, and foresee and influence the future, one must be able to perform the dual intellectual task implicit in these questions. One must be able to distinguish between the similarities and differences in two political situations. Furthermore, one must be able to assess the import of these similarities and differences for alternative foreign policies. Three series of events taken at random will illustrate the problem and its difficulties.

1. On September 17, 1796, George Washington made a speech in which he bade farewell to the nation, outlining among other things the principles of American foreign policy. On December 2, 1823, President Monroe sent a message to Congress in which he, too, formulated the principles of American foreign policy. In 1917, the United States joined France and Great Britain against a nation which threatened the independence of both. In 1941, the United States followed a similar course of action. On March 12, 1947, President Truman, in a message to Congress, reformulated the principles of American foreign policy.

2. In 1512, Henry VIII made an alliance with the Hapsburgs against France. In 1515, he made an alliance with France against the Hapsburgs. In 1522 and 1542, he joined the Hapsburgs against France. In 1756, Great Britain allied itself with Prussia against the Hapsburgs and France. In 1793, Great Britain, Prussia, and the Hapsburgs were allied against Napoleon. In 1914, Great Britain joined with France and Russia against Austria and Germany, and, in 1939, with France and Poland against Germany.

3. Napoleon, William II, and Hitler tried to conquer the continent of Europe and failed.

Are there within each of these three series of events similarities which allow us to formulate a principle of foreign policy for each series? Or is each event so different from the others in the series that each would require a different policy? The difficulty in making this decision is the measure of the difficulty in making correct judgments in international affairs, in charting the future wisely, and in doing the right things in the right way and at the right time.

Should the foreign policy of Washington's Farewell Address be considered a general principle of American foreign policy, or did it stem from temporary conditions and was it, therefore, bound to disappear with them? Are the foreign policies of Washington's and Monroe's messages compatible with the Truman Doctrine? Stated another way, is the Truman Doctrine a mere

Politics among Nations

modification of a general principle underlying Washington's and Monroe's conception of foreign affairs, or does the Truman Doctrine constitute a radical departure from the traditions of American foreign policy? If it does, is it justified in the light of changed conditions? Generally speaking, are the differences in the international position of the United States in 1796, 1823, 1917, 1941, and 1947 such as to justify the different foreign policies formulated and executed with regard to these different political situations? More particularly, what are the similarities and differences in the situation with which Europe confronted the United States in 1917, 1941, and 1947, and to what extent do they require similar or different foreign policies on the part of the United States?

What is the meaning of these shifts in British foreign policy? Are they the outgrowth of the whim and perfidy of princes and statesmen? Or are they inspired by the accumulated wisdom of a people, mindful of the permanent forces which determine their relations to the continent of Europe?

Are the disasters which follow in the wake of the three attempts at continental conquest so many accidents due to disparate causes? Or does the similarity in results point to similarities in the over-all political situation, similarities which convey a lesson to be pondered by those who might want to try again? More particularly, are the European policies of Stalin similar to those of Napoleon, William II, and Hitler? To the extent that they are, do they call for policies on the part of the United States similar to those pursued in 1917 and 1941?

Sometimes, as in the case of the retrospective analysis of British foreign policy, the answer seems to be clear. We shall have more to say about that later. Most of the time, however, and especially when we deal with the present and the future, the answer is bound to be tentative and subject to qualifications. The facts from which the answer must derive are essentially ambiguous and subject to continuous change. To those men who would have it otherwise, history has taught nothing but false analogies. When they have been responsible for the foreign policies of their countries, they have brought only disaster. William II and Hitler learned nothing from Napoleon's fate, for they thought it could teach them nothing. Those who have erected Washington's advice into a dogma to be followed slavishly have erred no less than those who would dismiss it altogether.

The first lesson which the student of international politics must learn and never forget is that the complexities of international affairs make simple solutions and trustworthy prophecies impossible. It is here that the scholar and the charlatan part company. Knowledge of the forces which determine politics among nations, and knowledge of the ways by which their political relations proceed, reveals the ambiguity of the facts of international politics. In every political situation contradictory tendencies are at play. One of these tendencies is more likely to prevail under certain conditions than others. But which tendency actually will prevail is anybody's guess. ~~The best the scholar can do, then, is to trace the different tendencies which, as potentialities, are inferent in a certain international situation. He can point out the different conditions which make it more likely for one tendency to prevail than for~~

International Politics: A Dual Approach

another, and, finally, assess the probabilities for the different conditions and tendencies to prevail in actuality.

Because the facts of international politics are exposed to continuous change, world affairs have surprises in store for whoever tries to read the future from his knowledge of the past and from the signs of the present. Take the example of one of the greatest of British statesmen, the younger Pitt. In February 1792, in his budget speech to the House of Commons, Pitt justified the reduction of military expenditures (particularly the decrease by more than 11 per cent in the personnel of the British Navy) and held out hope for more reductions to come by declaring: "Unquestionably there never was a time in the history of this country when from the situation of Europe we might more reasonably expect fifteen years of peace than at the present moment." Only two months later the continent of Europe was engulfed in war. Less than a year later Great Britain was involved. Thus was initiated a period of almost continuous warfare which lasted nearly a quarter of a century.

When the prophecies of a great statesman fare so ill, what can we expect from the forecasts of lesser minds? In how many books written on international affairs before the First World War, when common opinion held great wars to be impossible or at least of short duration, was there even an inkling of what was to come? Is there a book, written in the period between the two world wars, which could have helped one anticipate what international politics would be like in the fifth decade of the century? Who could have guessed at the beginning of the Second World War what the political world would be like at its end? Who could have known in 1945 what it would be like in 1948? What trust then shall we place in those who today would tell us with absolute certainty what tomorrow and the day after will bring? ⁴

2. UNDERSTANDING THE PROBLEM OF INTERNATIONAL PEACE

This leads us to the second purpose of this book. No study of politics and certainly no study of international politics in the mid-twentieth century can be disinterested in the sense that it is able to divorce knowledge from action and to pursue knowledge for its own sake. International politics is no longer, as it was for the United States during most of its history, a series of incidents, costly or rewarding, but hardly calling into question the nation's very existence and destiny. The existence and destiny of the United States were more deeply affected by the domestic events of the Civil War than by the international policies leading up to, and evolving from, the Mexican

⁴ The fallibility of prophecies in international affairs is strikingly demonstrated by the fantastic errors committed by the experts who have tried to forecast the nature of the next war. The history of these forecasts, from Machiavelli to General J. F. C. Fuller, is the story of logical deductions, plausible in themselves, which had no connection with the contingencies of the actual historic development. General Fuller, for instance, foresaw in 1923 that the decisive weapon of the Second World War would be gas! See *The Reformation of War* (New York: E. P. Dutton and Company, 1923).

Politics among Nations

War, the Spanish-American War, and the Roosevelt corollary to the Monroe Doctrine.⁶

Two facts, peculiar to our time, have completely reversed the relative importance of domestic and international policies for the United States. One is that the United States is at the moment of this writing the most powerful nation on earth. Yet, in comparison with its actual and potential competitors, it is not so powerful that it can afford to ignore the effect of its policies upon its position among the nations. From the end of the Civil War to the beginning of the Second World War it mattered little what policies the United States pursued with regard to its Latin-American neighbors, China, or Spain. The self-sufficiency of its own strength, in conjunction with the operation of the balance of power, made the United States immune to the boundless ambition born of success and the fear and frustration which goes with failure. The United States could take success and failure in stride without being unduly tempted or afraid. Now it stands outside the enclosures of its continental citadel, taking on the whole of the political world as friend or foe. It has become dangerous and vulnerable, feared and afraid.

The risk of being very powerful, but not omnipotent, is aggravated by the second fact: a dual revolution in the political situation of the world. The multiple state system of the past, which in the moral sense was one world, has been transformed into two inflexible, hostile blocs, which are morally two worlds. On the other hand, modern technology has made possible total war. The predominance of these two new elements in contemporary international politics has not only made the preservation of world peace extremely difficult, it has also enormously increased the risks of war. Since in this world situation the United States holds a position of predominant power and, hence, of foremost responsibility, the understanding of the forces which mold international politics and of the factors which determine its course has become for the United States more than an interesting intellectual occupation. It has become a vital necessity.

To reflect on international politics in the United States, as we approach the mid-twentieth century, then, is to reflect on the problems which confront American foreign policy in our time. While at all times the promotion of the national interests of the United States as a power among powers has been the main concern of American foreign policy, in the age of two worlds and of total war the preservation of peace has become the prime concern of all nations. It yields in importance only to the most elemental considerations of national existence and security.

It is for this reason that this book is planned around the two concepts of power and peace. These two concepts are central to a discussion of world politics in the mid-twentieth century, when the greatest accumulation of power ever known gives to the problem of peace an urgency which it has never had before. In a world whose moving force is the aspiration for power

⁶ This corollary is found in the message of Theodore Roosevelt to Congress on December 6, 1904. In that message he proclaimed the right of the United States to intervene in the domestic affairs of the Latin-American countries. For the text, see Ruhl J. Bartlett, editor, *The Record of American Diplomacy: Documents and Readings in the History of American Foreign Relations* (New York: Alfred A. Knopf, 1947), p. 539.

International Politics: A Dual Approach

of sovereign nations, peace can be maintained only by two devices. One is the self-regulatory mechanism of the social forces which manifests itself in the struggle for power on the international scene, that is, the balance of power. The other consists of normative limitations upon that struggle in the form of international law, international morality, and world public opinion. Since neither of these devices, as they operate today, is capable of keeping the struggle for power within peaceful bounds, three further questions must be asked and answered. What is the value of the main current proposals for the maintenance of international peace? More particularly, what is the value of the proposal for doing away with the very structure of an international society of sovereign nations by establishing a world state? And, finally, what must a program for action be like which, mindful of the lessons of the past, endeavors to adapt them to the problems of the present?

PART TWO

INTERNATIONAL POLITICS AS
A STRUGGLE FOR POWER



CHAPTER I

Political Power

I. WHAT IS POLITICAL POWER?¹

International politics, like all politics, is a struggle for power. Whatever the ultimate aims of international politics, power is always the immediate aim. Statesmen and peoples may ultimately seek freedom, security, prosperity, or power itself. They may define their goals in terms of a religious, philosophic, economic, or social ideal. They may hope that this ideal will materialize through its own inner force, through divine intervention, or through the natural development of human affairs. But whenever they strive to realize their goal by means of international politics, they do so by striving for power. The Crusaders wanted to free the holy places from domination by the Infidels; Woodrow Wilson wanted to make the world safe for democracy; the National Socialists wanted to open Eastern Europe to German colonization, to dominate Europe, and to conquer the world. Since they chose power to achieve these ends, they were actors on the scene of international politics.²

When we speak of power (in the context of this book, we have in mind not man's power over nature, or over an artistic medium, such as language, speech, sound, or color, or over the means of production or consumption, or over himself in the sense of self-control. When we speak of power, we mean man's control over the minds and actions of other men. By political power we refer to the mutual relations of control among the holders of public authority and between the latter and the people at large.

Political power, however, must be distinguished from force in the sense of the actual exercise of physical violence. If the threat of physical violence in the form of police action, imprisonment, capital punishment, or war is an intrinsic element of politics. When violence becomes an actuality, it signifies

¹ The concept of political power poses one of the most difficult and controversial problems of political science. The value of any particular concept will be determined by its ability to explain a maximum of the phenomena which are conventionally considered to belong to a certain sphere of political activity. Thus a concept of political power, to be useful for the understanding of international politics, must be broader than one adopted to operate in the field of municipal politics. The political means employed in the latter are much more narrowly circumscribed than are those employed in international politics.

² For some suggestive remarks on power in relation to international politics, see Lionel Robbins, *The Economic Causes of War* (London: Jonathan Cape, 1939), pp. 63 ff.

Politics among Nations

the abdication of political power in favor of military or pseudo military power.) In international politics in particular, armed strength as a threat or a potentiality is the most important material factor making for the political power of a nation. If it becomes an actuality in war, it signifies the substitution of military for political power. The actual exercise of physical violence substitutes for the psychological relation between two minds, which is of the essence of political power, the physical relation between two bodies, one of which is strong enough to dominate the other's movements. It is for this reason that in the exercise of physical violence the psychological element of the political relationship is lost, and that we must distinguish between military and political power.

Political power is a psychological relation between those who exercise it and those over whom it is exercised. It gives the former control over certain actions of the latter through the influence which the former exert over the latter's minds. That influence may be exerted through orders, threats, persuasion, or a combination of any of these. The President of the United States, for instance, exerts political power over the executive branch of the government so long as his orders are obeyed by the members of that branch. The leader of a party has political power so long as he is able to mold the actions of the members of the party according to his will. We refer to the political power of an industrialist, labor leader, or lobbyist in so far as his preferences influence the actions of other men. The United States exerts political power over Puerto Rico so long as the laws of the United States are observed by the citizens of that island. When we speak of the political power of the United States in Central America, we have in mind the conformity of the actions of Central American governments with the wishes of the government of the United States.³ Thus the statement that A has or wants political power over B signifies always that A is able, or wants to be able, to control certain actions of B through influencing B's mind.

Whatever the material objectives of a foreign policy, such as the acquisition of sources of raw materials, the control of sea lanes, or territorial changes, they always entail control of the actions of others through influence over their minds. The Rhine frontier as a century-old objective of French foreign policy points to the political objective to destroy the desire of Germany to attack France by making it physically difficult or impossible for Germany to do so. Great Britain owed its predominant position in world politics throughout the nineteenth century to the calculated policy of making it either too dangerous (because Great Britain was too strong) or unattractive (because its strength was used with moderation) for other nations to oppose it.

The political objective of military preparations of any kind is to deter other nations from attack by making it too risky for them to do so. The political aim of military preparations is, in other words, to make the actual application of military force unnecessary by inducing the prospective enemy

³ The examples in the text illustrate also the distinction between political power as mere social fact, as in the case of the lobbyist, and political power in the sense of legitimate authority, i.e., of the President of the United States. Both the President of the United States and the lobbyist exercise political power, however different its source and nature may be.

to desist from the use of military force. The political objective of war itself is not per se the conquest of territory and the annihilation of enemy armies, but a change in the mind of the enemy which will make him yield to the will of the victor.

Therefore, whenever economic, financial, territorial, or military policies are under discussion in international affairs, it is necessary to distinguish between economic policies which are undertaken for their own sake and economic policies which are the instrumentalities of a political policy, that is to say, a policy whose economic purpose is but the means to the end of controlling the policies of another nation. The export policy of Switzerland with regard to the United States falls into the first category. The economic policies of the Soviet Union with regard to the Eastern and Southeastern European nations fall into the latter category. So do many policies of the United States in Latin America and Europe. The distinction is of great practical importance, and the failure to make it has led to much confusion in policy and public opinion.

An economic, financial, territorial, or military policy undertaken for its own sake is subject to evaluation in its own terms. Is it economically or financially advantageous? What effects has acquisition of territory upon the population and economy of the nation acquiring it? What are the consequences of a change in a military policy for education, population, and the domestic political system? The decisions with respect to these policies are made exclusively in terms of such intrinsic considerations.

When, however, the objectives of these policies serve to increase the power of the nation pursuing them with regard to other nations, these policies and their objectives must be judged primarily from the point of view of their contribution to national power. An economic policy which cannot be justified in purely economic terms might nevertheless be undertaken in view of the political policy pursued. The insecure and unprofitable character of a loan to a foreign nation may be a valid argument against it on purely financial grounds. But the argument is irrelevant if the loan, however unwise it may be from a banker's point of view, serves the political policies of the nation. It may, of course, be that the economic or financial losses involved in such policies will weaken the nation in its international position to such an extent as to outweigh the political advantages to be expected. On these grounds such policies might be rejected. In such a case, what decides the issue is, however, not purely economic and financial considerations, but a comparison of the political changes and risks involved, that is, the probable effect of these policies upon the international power of the nation.

2. THE DEPRECIATION OF POLITICAL POWER

~~The aspiration for power being the distinguishing element of international politics, as of all politics, international politics is of necessity power politics.~~ While this fact is generally recognized in the practice of international affairs, it is frequently denied in the pronouncements of scholars, publicists, and even statesmen. Since the end of the Napoleonic Wars, ever larger

Politics among Nations

groups in the Western World have been persuaded that the struggle for power on the international scene is a temporary phenomenon, a historical accident which is bound to disappear once the peculiar historic conditions which have given rise to it have been eliminated. Thus Jeremy Bentham believed that the competition for colonies was at the root of all international conflicts. "Emancipate your colonies!" was his advice to the governments, and international conflict and war would of necessity disappear.⁴ Adherents of free trade, such as Cobden⁵ and Proudhon,⁶ were convinced that the removal of trade barriers was the only condition for the establishment of permanent harmony among nations and might even lead to the disappearance of international politics altogether. "At some future election," said Cobden, "we may probably see the test 'no foreign politics' applied to those who offer to become the representatives of free constituencies."⁷ For Marx and his followers, capitalism is at the root of international discord and war. They maintain that international socialism will do away with the struggle for power on the international scene and bring about permanent peace. During the nineteenth century, liberals everywhere shared the conviction that power politics and war were residues of an obsolete system of government and that, with the victory of democracy and constitutional government over absolutism and autocracy, international harmony and permanent peace would win out over power politics and war. Of this liberal school of thought, Woodrow Wilson was the most eloquent and most influential spokesman.

In recent times, the conviction that the struggle for power can be eliminated from the international scene has been connected with the great attempts at organizing the world, such as the League of Nations and the United Nations. Thus Cordell Hull, then Secretary of State, declared in 1943 on his return from the Moscow Conference, which laid the groundwork for the United Nations, that the new international organization would mean the end of power politics and usher in a new era of international collaboration.⁸ Mr. Philip Noel-Baker, then British Minister of State, declared in 1946 in the House of Commons that the British government was "determined to use the institutions of the United Nations to kill power politics, in order that, by the methods of democracy, the will of the people shall prevail."⁹

While we shall have more to say later about these theories and the expectations derived from them,¹⁰ it is sufficient to state that the struggle for

⁴ *Emancipate Your Colonies* (London: Robert Heward, 1830).

⁵ "Free Trade! What is it? Why, breaking down the barriers that separate nations; those barriers, behind which nestle the feelings of pride, revenge, hatred, and jealousy, which every now and then burst their bounds, and deluge whole countries with blood." "Free trade is the international law of the Almighty," and free trade and peace seem to be "one and the same cause." See *Speeches by Richard Cobden* (London: The Macmillan Company, 1870), I, 79; *Political Writings* (New York: D. Appleton and Company, 1867), II, 110; letter of April 12, 1842, to Henry Ashworth, quoted in John Morley, *Life of Richard Cobden* (Boston: Roberts Brothers, 1881), p. 154.

⁶ "Let us suppress the tariffs, and the alliance of the peoples will thus be declared, their solidarity recognized, their equality proclaimed." *Oeuvres complètes* (Paris, 1867), I, 248.

⁷ Quoted in A. C. F. Beales, *A Short History of English Liberalism*, p. 195.

⁸ *New York Times*, November 19, 1943, p. 1.

⁹ *House of Commons Debates* (Fifth Series, 1946), Vol. 419, p. 1262.

¹⁰ See Part Eight.

Political Power

power is universal in time and space and is an undeniable fact of experience. It cannot be denied that throughout historic time, regardless of social, economic, and political conditions, states have met each other in contests for power. Even though anthropologists have shown that certain primitive peoples seem to be free from the desire for power, nobody has yet shown how their state of mind and the conditions under which they live can be recreated on a world-wide scale so as to eliminate the struggle for power from the international scene.¹¹ It would be useless and even self-destructive to free one or the other of the peoples of the earth from the desire for power while leaving it extant in others. If the desire for power cannot be abolished everywhere in the world, those who might be cured would simply fall victims to the power of others.

The position taken here might be criticized on the ground that conclusions drawn from the past are unconvincing, and that to draw such conclusions has always been the main stock-in-trade of the enemies of progress and reform. Though it is true that certain social arrangements and institutions have always existed in the past, it does not necessarily follow that they must always exist in the future. The situation is, however, different when we deal, not with social arrangements and institutions created by man, but with those elemental bio-psychological drives by which in turn society is created. The drives to live, to propagate, and to dominate are common to all men.¹² Their relative strength is dependent upon social conditions which may favor one drive and tend to repress another, or which may withhold social approval from certain manifestations of these drives, while they encourage others. Thus, to take examples only from the sphere of power, most societies condemn killing as a means of attaining power within the society, but all societies encourage the killing of enemies in that struggle for power which is called war. Dictators look askance at the aspirations for political power among their fellow citizens, but democracies consider active participation in the competition for political power a civic duty. Where a monopolistic organization of economic activities exists, competition for economic power is absent, and in competitive economic systems certain manifestations of the struggle for economic power are outlawed, while others are encouraged.

Regardless of particular social conditions, the decisive argument against the opinion that the struggle for power on the international scene is a mere historic accident can, however, be derived from the nature of domestic politics. The essence of international politics is identical with its domestic counterpart. Both domestic and international politics are a struggle for power, modified only by the different conditions under which this struggle takes place in the domestic and in the international spheres.

The desire to dominate in particular is a constitutive element of all human associations, from the family through fraternal and professional asso-

¹¹ For an illuminating discussion of this problem, see Malcolm Sharp, "Aggression: A Study of Values and Law," *Ethics*, Vol. 57, No. 4, Part II (July 1947).

¹² Zoologists have shown that the drive to dominate is to be found even in animals, such as chickens and monkeys, who create social hierarchies on the basis of the will and the ability to dominate; see, e.g., Warder Allee, *Animal Life and Social Growth* (Baltimore: The Williams and Wilkins Company, 1932) and *The Social Life of Animals* (New York: W. W. Norton and Company, Inc., 1938).

Politics among Nations

ciations and local political organizations to the state. On the family level, the typical conflict between the mother-in-law and her child's spouse is in its essence a struggle for power, the defense of an established power position against the attempt to establish a new one. As such it foreshadows the conflict on the international scene between the policies of the status quo and the policies of imperialism. Social clubs, fraternities, faculties, and business organizations are scenes of continuous struggles for power between groups which either want to keep what power they already have or desire to attain greater power. Competitive contests between business enterprises as well as labor disputes between employers and employees are frequently fought not only, and sometimes not even primarily, for economic advantages, but for influence over each other and over others, that is, for power. Finally, the whole political life of a nation, particularly of a democratic nation, from the local to the national level, is a continuous struggle for power. In periodical elections, in voting in legislative assemblies, in law suits before courts, in administrative decisions and executive measures—in all these activities men try to maintain or to establish their power over other men. The processes by which legislative, judicial, executive, and administrative decisions are reached are subject to pressures and counterpressures by "pressure groups" trying to defend and expand their positions of power.

In view of this ubiquity of the struggle for power in all social relations and on all levels of social organization, is it surprising that international politics is of necessity power politics? And would it not be rather surprising if the struggle for power were but an accidental and ephemeral attribute of international politics when it is a permanent and necessary element of all branches of domestic politics?

3. TWO ROOTS OF THE DEPRECIATION OF POLITICAL POWER

The depreciation of the role power plays on the international scene grows from two roots. One is the philosophy of international relations which dominated the better part of the nineteenth century and still holds sway over much of our thinking on international affairs. The other is the particular political and intellectual circumstances which have determined the relations of the United States of America to the rest of the world.

The nineteenth century was led to its depreciation of power politics by its domestic experience. The distinctive characteristic of this experience was the domination of the middle classes by the aristocracy. By identifying this domination with political domination of any kind, the political philosophy of the nineteenth century came to identify the opposition to aristocratic politics with hostility to any kind of politics. After the defeat of aristocratic government, the middle classes developed a system of indirect domination. They replaced the traditional division into the governing and governed classes, and the military method of open violence, characteristic of aristocratic rule, with the invisible chains of economic dependence. This economic system operated through a network of seemingly equalitarian legal rules which con-

cealed the very existence of power relations. The nineteenth century was unable to see the political nature of these legalized relations. They seemed to be essentially different from what had gone, so far, under the name of politics. Therefore, politics in its aristocratic, that is, open and violent form was identified with politics as such. The struggle, then, for political power—in domestic as well as in international affairs—appeared to be only a historic accident, coincident with autocratic government and bound to disappear with the disappearance of autocratic government.

This identification of power politics with aristocratic government found support in the American experience. It can be traced to three elements in that experience: the uniqueness of the American experiment, the actual isolation of the American continent from the centers of world conflict during the nineteenth century, and the humanitarian pacifism and anti-imperialism of American political ideology.

That the severance of constitutional ties with the British crown was meant to signify the initiation of an American foreign policy distinct from what went under the name of foreign policy in Europe is clearly stated in Washington's Farewell Address. "Europe has a set of primary interests, which to us have none, or a very remote relation. Hence she must be engaged in frequent controversies, the causes of which are essentially foreign to our concerns. Hence, therefore, it must be unwise in us to implicate ourselves, by artificial ties, in the ordinary vicissitudes of her politics, or the ordinary combinations and collisions of her friendships or enmities." In 1796, European politics and power politics were identical; there was no other power politics but the one engaged in by the princes of Europe. "The toils of European ambition, rivalry, interest, humor or caprice" were the only manifestations of the struggle for international power before the American eye. The retreat from European politics, as proclaimed by Washington, could, therefore, be taken to mean retreat from power politics as such.

Yet American aloofness from the European tradition of power politics was more than a political program. Certain sporadic exceptions notwithstanding, it was an established political fact until the end of the nineteenth century. The actuality of this fact was a result of deliberate choice as well as of the objective conditions of geography. Popular writers might see in the uniqueness of America's geographic position the hand of God which had unalterably prescribed the course of American expansion as well as isolation. But more responsible observers, from Washington on, have been careful to emphasize the conjunction of geographic conditions and of a foreign policy choosing its ends in the light of geography, using geographic conditions to attain those ends. Washington referred to "our detached and distant situation" and asked, "Why forego the advantages of so peculiar a situation?" When this period of American foreign policy drew to a close, John Bright wrote to Alfred Love: "On your continent we may hope your growing millions may henceforth know nothing of war. None can assail you; and you are anxious to abstain from mingling with the quarrels of other nations."¹⁸

¹⁸ Merle Curti, *Peace and War: The American Struggle 1636-1936* (New York: W. W. Norton and Company, 1936), p. 122.

Politics among Nations

From the shores of the North American continent, the citizens of the new world watched the strange spectacle of the struggle for international power unfolding on the distant scenes of Europe, Africa, and Asia. Since for the better part of the nineteenth century their foreign policy enabled them to retain the role of spectators, what was actually the result of a passing historic constellation appeared to Americans as a permanent condition, self-chosen as well as naturally ordained. At worst they would continue to watch the game of power politics played by others. At best the time was close at hand when, with democracy established everywhere, the final curtain would fall and the game of power politics would no longer be played.

To aid in the achievement of this goal was conceived to be part of America's mission. Throughout the nation's history, the national destiny of the United States has been understood in antimilitaristic, libertarian terms. Where that national mission finds a nonaggressive, abstentionist formulation, as in the political philosophy of John C. Calhoun, it is conceived as the promotion of domestic liberty. Thus we may "do more to extend liberty by our example over this continent and the world generally, than would be done by a thousand victories." When the United States, in the wake of the Spanish-American War, seemed to desert this anti-imperialist and democratic ideal, William Graham Sumner restated its essence: "Expansion and imperialism are a grand onslaught on democracy . . . expansion and imperialism are at war with the best traditions, principles, and interests of the American people."¹⁴ Comparing the tendencies of European power politics with the ideals of the American tradition, Sumner thought with Washington that they were incompatible. Yet, as a prophet of things to come, he saw that with the conclusion of the Spanish-American War America was irrevocably committed to the same course which was engulfing Europe in revolution and war.

Thus the general conception which the nineteenth century had formed of the nature of foreign affairs combined with specific elements in the American experience to create the belief that involvement in power politics is not inevitable, but only a historic accident, and that nations have a choice between power politics and other kinds of foreign policy not tainted by the desire for power.

¹⁴ "The Conquest of the United States by Spain," *Essays of William Graham Sumner* (New Haven: Yale University Press, 1940), II, 295.

CHAPTER II

The Struggle for Power: Policy of the Status Quo

Domestic and international politics are but two different manifestations of the same phenomenon: the struggle for power. Its manifestations differ in the two different spheres because different moral, political, and general social conditions prevail in each sphere. National societies show a much greater degree of social cohesion within themselves than among themselves. Cultural uniformity, technological unification, external pressure, and, above all, a hierarchic political organization co-operate in making the national society an integrated whole set apart from other national societies. In consequence, the domestic political order is, for instance, more stable and to a lesser degree subject to violent change than is the international order.

The history of the nations active in international politics shows them continuously preparing for, actively involved in, or recovering from organized violence in the form of war. In domestic politics, on the other hand, organized violence as an instrument of political action on an extensive scale has become a rare exception. Yet as a potentiality it exists here, too, and at times the fear of it in the form of revolution has exerted an important influence upon political thought and action.¹ Hence, the difference between domestic and international politics in this respect is one of degree and not of kind.

All politics, domestic and international, reveals three basic patterns, that is to say, all political phenomena can be reduced to one of three basic types.

A political policy seeks either to keep power, to increase power, or to demonstrate power.

To these three typical patterns of politics, three typical international policies correspond. A nation whose foreign policy tends toward keeping power and not toward changing the distribution of power in its favor pursues a policy of the status quo. A nation whose foreign policy aims at acquiring more power than it actually has through expansion of its power beyond its frontiers, whose foreign policy, in other words, seeks a favorable change in power status, pursues a policy of imperialism. A nation whose foreign policy

¹ This is true especially of the nineteenth century, as Guglielmo Ferrero has pointed out in *The Principles of Power* (New York: G. P. Putnam's Sons, 1942).

Politics among Nations

aims to demonstrate the power it has, either for the purpose of maintaining or increasing it, pursues a policy of prestige.³ It should be noted that these formulations are of a provisional nature and are subject to further refinement.⁴

The concept "status quo" is derived from *status quo ante bellum*, a diplomatic term referring to the usual clauses in peace treaties which provide for the evacuation of territory by enemy troops and its restoration to the prewar sovereignty. Thus the peace treaties with Italy⁵ and Bulgaria⁶ terminating the Second World War provide that "all armed forces of the Allied and Associated Powers shall be withdrawn" from the territory of the particular nation "as soon as possible and in any case not later than ninety days from the coming into force of the present Treaty."⁷ That is, within this time limit the *status quo ante bellum* shall be re-established with regard to this territory.⁷

The policy of the status quo aims at the maintenance of the distribution of power which exists at a particular moment in history. One might say that the policy of the status quo fulfills the same function for international politics that a conservative policy performs for domestic affairs. The particular moment in history which serves as point of reference for a policy of the status quo is frequently the distribution of power as it exists at the end of a war and as it is codified in a treaty of peace. This is so because the main purpose of peace treaties is to formulate in legal terms the shift in power which victory and defeat in the preceding war have brought about, and to insure the stability of the new distribution of power by means of legal stipulations. Thus it is typical for a status quo policy to appear as defense of the peace settlement which terminated the last general war. The European govern-

³ It is not a departure from this threefold pattern of international politics when sometimes a nation gives up power without being physically compelled to do so, as Great Britain did with regard to India in 1947 and as the United States has done on several occasions with regard to Latin-American countries. In such cases a nation acts like a military commander who may retreat under certain circumstances, either because his front is overextended or his lines of communication are threatened or because he wants to concentrate his forces for an attack. Similarly, a nation may retreat from an exposed power position which it cannot hope to hold very long. Or it may exchange one kind of control for another kind, e.g., military for political control, political for economic control, or vice versa (the substitution of the Good Neighbor Policy for the policy of the "big stick" is a case in point). Or a change in the objectives of its foreign policy may require concentration of effort at another point. In any case, the fact that it gives up power voluntarily cannot be taken to mean that it is not interested in power, any more than the retreat of a military commander proves that he is not interested in military victory.

⁴ It must especially be pointed out that these different patterns of international policies do not of necessity correspond to conscious motivations in the minds of statesmen or supporters of the respective foreign policies. Statesmen and supporters may not even be aware of the actual character of the policies they pursue and support. More particularly, a nation may intend to pursue a policy of the status quo, while actually, without being aware of it, it is embarking upon a policy of imperialism. Thus it has been said of the British that they acquired their empire in a "fit of absent-mindedness." In what follows at this point in the text we are exclusively concerned with the actual character of the policies pursued and not with the motives of those who pursue them.

⁵ See Article 73, *New York Times*, January 18, 1947, p. 26.

⁶ See Article 20, *ibid.*, p. 32.

⁷ Article 22 of the peace treaty with Hungary and Article 21 of the peace treaty with Rumania (*ibid.*, pp. 31, 34) contain a similar provision, subject only to the right of the Soviet Union to keep on the respective territories the troops necessary for the maintenance of lines of communications with its occupation forces in Austria.

⁸ For a great number of older examples, see Coleman Phillipson, *Termination of War and Treaties of Peace* (New York: E. P. Dutton and Company, 1916), pp. 223 ff.

Policy of the Status Quo

ments and political parties which, from 1815 to 1848, pursued a policy of the status quo did so in defense of the peace settlement of 1815. The main purpose of the Holy Alliance was the maintenance of the status quo as it existed at the conclusion of the Napoleonic Wars; in consequence it functioned mainly as a guarantor of the Treaty of Paris of 1815 which terminated the Napoleonic Wars.

In this respect, the relation between the policy in defense of the status quo of 1815, the Treaty of Paris, and the Holy Alliance is similar to the relation between the policy in favor of the status quo of 1918, the peace treaties of 1919, and the League of Nations. The distribution of power as it existed at the end of the First World War found its legal expression in the peace treaties of 1919. It became the main purpose of the League of Nations to maintain peace by preserving the status quo of 1918 as it has been formulated in the peace treaties of 1919. Article 10 of the Covenant of the League, obligating its members "to respect and preserve as against external aggression the territorial integrity and existing political independence of all members of the League," recognizes as one of the purposes of the League the maintenance of the territorial status quo as established by the peace treaties of 1919. Consequently, in the period between the two world wars the struggle for and against the status quo was in the main fought either by defending or opposing the territorial provisions of the Treaty of Versailles and their guarantee in Article 10 of the Covenant of the League. It was, therefore, only consistent from their point of view that the nations chiefly opposed to the status quo established in 1919 should sever their connections with the League of Nations — Japan in 1932, Germany in 1933, Italy in 1937.

It is, however, not only in peace treaties and international organizations supporting them that the policy of the status quo manifests itself. Nations desiring to maintain a certain distribution of power may use as their instrument special treaties, such as "The Nine Power Treaty relating to Principles and Policies to be followed in Matters concerning China," signed at Washington, February 6, 1922,⁸ and the "Treaty of Mutual Guarantee between Germany, Belgium, France, Great Britain, and Italy," signed at Locarno, October 16, 1925.⁹

The Nine Power Treaty transformed the American policy of the "open door" in China into a multilateral policy which the nations mostly interested in trade with China, as well as China itself, pledged themselves to uphold. Its main purpose was to stabilize the distribution of power which existed at the time between the contracting nations with regard to China. This meant that the special rights which certain nations, especially Great Britain and Japan, had acquired in certain parts of Chinese territory, such as Manchuria and various ports, should not only remain intact but that no new special rights should be ceded by China to any of the contracting parties.

The Locarno Treaty of mutual guarantee endeavored to supplement the general guarantee of the territorial status quo of 1918, contained in Article 10 of the Covenant of the League, with a special one with respect to the

⁸ United States *Treaty Series*, No. 671 (Washington, 1923).

⁹ *American Journal of International Law*, Vol. 20 (1926), Supplement, p. 22.

Politics among Nations

western frontiers of Germany. Article 1 of the Treaty expressly referred to the guarantee of "the maintenance of the territorial status quo resulting from the frontiers between Germany and Belgium and between Germany and France."

Alliance treaties, in particular, have frequently the function of preserving the status quo in certain respects. Thus, after the victorious conclusion of the war against France and the foundation of the German Empire in 1871, Bismarck tried to protect the newly won dominant position of Germany in Europe by alliances which were intended to prevent a war of revenge on the part of France. In 1879, Germany and Austria concluded an alliance for mutual defense against Russia, and, in 1894, France and Russia entered into a defensive alliance against the German-Austrian combination. The mutual fear lest the other alliance be intent upon changing the status quo while professing to maintain it was one of the main factors in bringing about the general conflagration of the First World War.

The alliance treaties which France concluded with the Soviet Union, Poland, Czechoslovakia, Yugoslavia, and Rumania in the period between the two world wars were intended to maintain the status quo, mainly in view of possible German attempts to change it. Similar treaties between Czechoslovakia, Yugoslavia, and Rumania, and the treaty between Czechoslovakia and the Soviet Union had the same purpose. The ineffectiveness of this system of alliances when it was put to the test from 1935 to 1939 was one of the reasons for Germany's attack on Poland. The British-Polish Alliance of April 5, 1939, was the last attempt, before the outbreak of hostilities, to preserve at least the territorial status quo on the eastern German frontier. Today the alliances which the Soviet Union has concluded with the countries of Eastern Europe and which the countries of Western Europe have concluded among themselves aim similarly at the maintenance of the status quo in these respective European regions as it was established by the distribution of power at the end of the Second World War.

The manifestation of the policy of the status quo which has had the greatest importance for the United States and has been the cornerstone of its foreign relations is the Monroe Doctrine. A unilateral declaration made by President Monroe in his annual message to Congress on December 2, 1823, the Doctrine lays down the two essential principles of any status quo policy. On the one hand, it stipulates on the part of the United States respect for the existing distribution of power in the Western Hemisphere: "With the existing colonies or dependencies of any European power we have not interfered and shall not interfere." On the other hand, it proclaims resistance on the part of the United States to any change of the existing distribution of power by any non-American nation: "But with the governments who have declared their independence, and maintain it, . . . we could not view any interposition for the purpose of oppressing them, or controlling in any other manner their destiny, by any European power, in any other light than as the manifestation of an unfriendly disposition towards the United States." As President Franklin D. Roosevelt expressed it in an address before the Governing Body of the Pan-American Union on April 12, 1933: "It [the Monroe Doctrine] was

Policy of the Status Quo

aimed and is aimed against the acquisition in any manner of the control of additional territory in this hemisphere by any non-American power."¹⁰

We have said that the policy of the status quo aims at the maintenance of the distribution of power as it exists at a particular moment in history. This does not mean that the policy of the status quo is necessarily opposed to any change whatsoever. While it is not opposed to change as such, it is opposed to any change which would amount to a reversal of the power relations among two or more nations, reducing, for instance, A from a first-rate to a second-rate power and raising B to the eminent position A formerly held. Minor adjustments in the distribution of power, however, which leave intact the relative power positions of the nations concerned, are fully compatible with a policy of the status quo. For instance, the purchase of the territory of Alaska by the United States in 1867 did not then affect the status quo between the United States and Russia, since, in view of the technology of communications and warfare at the time, the acquisition by the United States of this then inaccessible territory did not affect to any appreciable extent the distribution of power between the United States and Russia.

Similarly, by acquiring the Virgin Islands from Denmark in 1917, the United States did not embark upon a policy aiming at a change of the status quo with regard to the Central American republics. While the acquisition of the Virgin Islands greatly improved the strategic position of the United States in so far as the defense of the approaches to the Panama Canal was concerned, it did not change the relative power positions of the United States and the Central American republics. The acquisition of the Virgin Islands may have strengthened the already dominant position of the United States in the Caribbean, yet it did not create it and, therefore, was compatible with a policy of the status quo. One might even say that, by strengthening the preponderance of the United States over the Central American republics, it actually reinforced the existing distribution of power and thus served the purposes of a policy of the status quo.

¹⁰ *Roosevelt's Foreign Policy, 1933-41. F.D.R.'s Unedited Speeches and Messages* (New York: Wilfred Funk, Inc., 1942), p. 4.

CHAPTER III

The Struggle for Power: Imperialism

I. WHAT IMPERIALISM IS NOT

An objective analysis of the acquisition of the Virgin Islands by the United States might show that it was part of a policy of the status quo in that region. Nevertheless, these and similar moves toward strengthening the position of the United States in the Caribbean have been decried as imperialistic by many observers. Such observers have used the term "imperialistic" not for the purpose of characterizing objectively a particular type of foreign policy, but as a term of opprobrium by which a policy to which the observer is opposed can be discredited. This arbitrary use of the term for polemical purposes has become so widespread that today "imperialism" and "imperialistic" are indiscriminately applied to any foreign policy, regardless of its actual character, to which the user happens to be opposed.

Anglophobes will refer to British imperialism as an actuality in 1948, as they did in 1940 or in 1914. Russophobes will call imperialistic whatever the Russians do in foreign affairs. The Second World War was considered imperialistic in motivation by the Soviet Union until it was attacked in 1941. In Russian eyes, the war then became anti-imperialistic. To enemies and critics of the United States everywhere "American imperialism" is a standard term. To add to the confusion, economic systems, political systems, and economic groups, such as bankers and industrialists, are indiscriminately identified with imperialistic foreign policies.

In this process of indiscriminate usage the term "imperialism" has lost all concrete meaning. Everybody is an imperialist to someone who happens to take exception to his foreign policies. Under such circumstances it becomes the task of a scholarly study to break with popular usage in order to give the term an ethically neutral, objective, and definable meaning which at the same time is useful for the theory and practice of international affairs.¹

Before we ask what imperialism actually is, let us ask first what imperial-

¹ The term is frequently used as synonymous with any kind of colonial expansion, as, for instance, in Parker Thomas Moon, *Imperialism and World Politics* (New York: The Macmillan Company, 1926). Such use is unobjectionable from a scientific point of view, so long as it implies no general theory of the nature of expansionist policies as such. Since in the text we are concerned with the general characteristics of international policies of expansion, it is obvious that a concept limited to the phenomena of colonial expansion is too narrow for our purposes.

ism is not, but is most often supposed to be. The three most popular misconceptions require our attention.

1. [Not every foreign policy aiming at an increase in the power of a nation is necessarily a manifestation of imperialism.] We have already disposed of this misconception in our discussion of the policy of the status quo.² We defined imperialism as a policy which aims at the overthrow of the status quo, at a reversal of the power relations between two or more nations. A policy seeking only adjustment, leaving the essence of these power relations intact, still operates within the general framework of a policy of the status quo.

The view that imperialism and any purposeful increase in power are identical is held mainly by two distinct groups. Those who are opposed on principle to a particular nation and its policies, such as Anglophobes, Russophobes, and anti-Americans, regard the very existence of the object of their phobia as a threat to the world. Whenever a country, thus feared, sets out to increase its power, those who fear it must view the increase in power as a stepping-stone to world conquest, that is, as manifestation of an imperialistic policy. On the other hand, those who, as heirs of the political philosophy of the nineteenth century, consider any active foreign policy an evil bound to disappear in the foreseeable future will condemn a foreign policy that seeks an increase in power. They will identify that foreign policy with what is for them the paradigm of evil — imperialism.

2. [Not every foreign policy aiming at the preservation of an empire that already exists is imperialism. It is widely believed that whatever a nation, such as Great Britain, France, the Soviet Union, or the United States, does in order to maintain its preponderant position in certain regions is imperialistic. Thus imperialism becomes identified with the maintenance, defense, and stabilization of an empire already in existence rather than with the dynamic process of acquiring one.] Yet, while it may make sense to apply the term "imperialism" to the domestic policies of an existing empire, it is confusing and misleading to apply the term to international policies of an essentially static and conservative character; for in the international field imperialism is contrasted with the policy of the status quo and, hence, has a dynamic connotation. The history of what is commonly called "British imperialism" is instructive in this regard.

The idea of British imperialism had its origin in Great Britain itself. It was used for the first time by the conservatives under Disraeli in the campaign for the elections of 1874. The idea of British imperialism, as conceived by Disraeli and developed later by Joseph Chamberlain and Winston Churchill, was opposed to what they called the cosmopolitanism and internationalism of the liberals. It found its concrete expression in the political program of "imperial federation." The most important points of this program were: (1) the unification and integration of Great Britain and its possessions into a unified empire with the aid of protective tariffs, (2) the reservation of free colonial land to Englishmen, (3) unified armed forces, and (4) a central representative organ in London.

² On this point see the discussion in Chapter II.

Politics among Nations

When this "imperialistic" program was postulated and put into effect, the territorial expansion of Great Britain had in the main come to an end. The program of British "imperialism" was, therefore, essentially a program of consolidation, not of expansion. It sought to secure and exploit what had already been appropriated. It endeavored to stabilize the distribution of power which had been brought about by the creation of the British Empire.

When Kipling justified British imperialism as "the white man's burden," the burden was already shouldered. Since the 1870's, British "imperialism," that is, British foreign policy with regard to Britain's oversea possessions, was in the main a policy of the status quo and not imperialistic at all in the exact meaning of the term. Yet the anti-imperialists in Great Britain and elsewhere, accepting the imperialistic slogans of Disraeli and Chamberlain at face value and mistaking the effects of imperialism for imperialism itself, opposed the British policy of exploitation and consolidation, especially in Africa and India, as "imperialistic." In fact, when Churchill refused "to preside over the liquidation of the British Empire," he was speaking not as an imperialist but as a conservative in foreign affairs, a defender of the status quo of empire.

British "imperialism" and its opponents are the outstanding examples of the confusion between the consolidation and defense of empire, on the one hand, and imperialism, on the other. But they are not the only examples. When we speak of the Roman Empire and of Roman imperialism, we think naturally of the period of Roman history which starts with Augustus, the first emperor governing what was then called for the first time *imperium Romanum*. Yet, when Augustus gave Rome and its possessions the constitution of an empire, the expansion of Rome had essentially come to an end. The foreign policy of the Republic, from the Punic Wars to its overthrow by Julius Caesar, had indeed been imperialistic in the exact meaning of the term. In that period the political face of the earth had been changed and made Roman. The foreign policy of the emperors and their perpetual wars served the main purpose of securing and protecting what had been conquered before. Not unlike the "imperialistic" policies of Great Britain from the time of Disraeli to Churchill, Roman foreign policy was one of conservation, of the status quo. When there were conquests, as under Trajan for instance, these policies served to make the empire and Roman supremacy secure.

The same is essentially true of the territorial aspects of American "imperialism" from the beginning of the twentieth century to the Second World War. The great debate for and against American imperialism which raged during the first decades of the century followed the great imperialistic expansion of the nineteenth century. The policy which was the object of that debate was essentially a policy of consolidation, of protection, of exploitation, that is, a policy of the status quo. When William Graham Sumner, in 1898, referred to the American policy of territorial expansion as "the conquest of the United States by Spain,"³ he referred to a policy which was already con-

³ See previous quotation, p. 20.

summed. When Senator J. Beveridge declared that "God has made us adepts in government that we may administer government among savage and senile peoples,"⁴ he endeavored to justify dominion already established rather than to support expansion planned for the future.

Thus, in both Great Britain and the United States, much of the modern debate on imperialism follows after the process of imperialistic expansion, condemning or justifying it in retrospect. In terms of actual policies to be pursued in the future, the debate is concerned primarily with the result of imperialistic policies, that is, the administration and safeguarding of empire. The explanation is not hard to find. The great debate started in Great Britain with the Conservative exaltation of the British Empire, a kind of British counterpart to the nationalism of the continent. The British Empire was a colonial empire and, as such, it became the prototype of modern empire. In consequence, the acquisition and exploitation of colonies became synonymous with empire, which thus received primarily, if not exclusively, an economic connotation. This economic connotation gave rise to the most extensive, most systematic, and also most popular body of thought which has sought to explain imperialism in modern times: the economic theories of imperialism. Here we find the third of the misconceptions which have obscured the true nature of imperialism.

2. ECONOMIC THEORIES OF IMPERIALISM

a) The Marxian, Liberal, and "Devil" Theories of Imperialism

The economic theories of imperialism have been developed in three different schools of thought: the Marxian, the liberal, and one which has aptly been called the "devil theory"⁵ of imperialism.

The Marxian theory of imperialism rests upon the conviction, which is the foundation of all Marxian thought, that all political phenomena are the reflection of economic conditions. Consequently, the political phenomenon of imperialism is the product of the economic system in which it originates, that is, capitalism. Capitalist societies, according to the Marxian theory, are unable to find within themselves sufficient markets for their products and sufficient investments for their capital. They have, therefore, a tendency to subjugate ever larger noncapitalist and, ultimately, even capitalist regions in order to transform them into markets for their surplus products and to give their surplus capital opportunities for investment.

The moderate Marxians, such as Kautsky and Hilferding, believed that imperialism was a policy of capitalism and that, therefore, an imperialistic policy was a matter of choice toward which capitalism might be more or less inclined according to circumstances. Lenin⁶ and his followers, especially

⁴ Speech in the Senate, January 9, 1900, reprinted in Ruhl J. Bartlett, *The Record of American Diplomacy* (New York: Alfred A. Knopf, 1947), p. 388.

⁵ Charles A. Beard, *The Devil Theory of War* (New York: The Vanguard Press, 1936); see also *The New Republic*, Vol. 86, March 4, 11, 18, 1936.

⁶ *Collected Works* (New York: International Publishers, 1927), Vol. 18; *Selected Works* (New York: International Publishers, 1935), Vol. 5.

Politics among Nations

Bukharin,⁷ on the other hand, identified imperialism and capitalism outright. Imperialism is identical with capitalism in its last, that is, monopoly stage of development. According to Lenin, "Imperialism is capitalism in that phase of its development in which the domination of monopolies and finance-capital has established itself; in which the export of capital has acquired very great importance; in which the division of the world among the big international trusts has begun; in which the partition of all the territory of the earth amongst the great capitalist powers has been completed."⁸

In the eyes of the Marxians capitalism is the main evil and imperialism only its necessary or probable manifestation. The liberal school, of which John A. Hobson⁹ is the chief representative, is mainly concerned with imperialism in which it finds the result, not of capitalism as such, but of certain maladjustments within the capitalist system. In conformity with Marxism, the liberal school diagnoses as the root of imperialism the surplus of goods and capital which seek outlets in foreign markets. Yet, according to Hobson and his school, imperialist expansion is not the inevitable and not even the most rational method of disposing of these surpluses. Since the surpluses are the result of the maldistribution of consuming power, the remedy lies in the expansion of the home market through economic reforms, such as payment of higher wages and elimination of oversavings. It is this belief in a domestic alternative to imperialism which in the main distinguishes the liberal school from Marxism.

The "devil theory" of imperialism operates on a much lower intellectual level than its two companion theories. It is widely held by pacifists and may be said to have been the official philosophy of the Nye Committee which in 1934-6 investigated on behalf of the United States Senate the influence of financial and industrial interests on the participation of the United States in the First World War. The publicity which the proceedings of this committee received made the "devil theory" of imperialism for a time the most popular explanation of foreign affairs in the United States. The simplicity of the theory contributed much to its popularity. It identified certain groups which obviously profited from war, such as manufacturers of war material (the so-called "munitions makers"), international bankers ("Wall Street"), and the like. Since they profited from war, they must be interested in having war. Thus the war profiteers transform themselves into the "war mongers," the "devils" who plan wars in order to enrich themselves.

While the extreme Marxians equate capitalism and imperialism, and while the moderate Marxians and the disciples of Hobson see in imperialism the result of maladjustments within the capitalist system, for the adherents of the "devil theory" imperialism and war in general amount to nothing but a conspiracy of evil capitalists for the purpose of private gain.

⁷ *Imperialism and World Economy* (New York: International Publishers, 1929). Of the writers who, aside from those mentioned in the text, have particularly influenced the development of the Marxian theory of imperialism, Rosa Luxemburg and Fritz Sternberg ought to be mentioned; cf. the latter's *The Coming Crisis* (New York: The John Day Company, 1946).

⁸ *Imperialism, the Highest Stage of Capitalism* (New York: International Publishers, 1933), p. 72.

⁹ *Imperialism* (London: G. Allen & Unwin, 1938).

b) Criticism of these Theories

All economic explanations of imperialism, the refined as well as the primitive, are unable to overcome the arguments derived from the evidence of history. The economic interpretation of imperialism erects a limited historic experience based on certain isolated cases into a universal law of history. It is indeed true that in the late nineteenth and in the twentieth centuries a small number of wars were waged primarily, if not exclusively, for economic objectives. The classic examples are the Boer War of 1899-1902 and the Chaco War between Bolivia and Paraguay from 1932-35. The main responsibility of British gold mining interests for the Boer War can hardly be doubted. The Chaco War is considered by some to have been primarily a war between two oil companies for the control of desirable oil fields.

However, during the entire period of mature capitalism, no war, with the exception of the Boer War, was waged by major powers exclusively or even predominantly for economic objectives. The Austro-Prussian War of 1866 and the Franco-German War of 1870, for instance, had no economic objectives of any importance. They were political wars, indeed imperialistic wars, fought for the purpose of establishing a new distribution of power, first in favor of Prussia within Germany and then in favor of Germany within the European state system. The Crimean War of 1854-56, the Spanish-American War of 1898, the Russo-Japanese War of 1904-05, the Turko-Italian War of 1911-12, and the several Balkan Wars show economic objectives only in a subordinate role, if they show them at all. The two world wars were certainly political wars, whose stake was the domination of Europe, if not of the world. Naturally, victory in these wars brought economic advantages and, more particularly, defeat brought in its wake economic losses. But these effects were not the real issue; they were only by-products of the political consequences of victory and defeat. Still less were these economic effects the motives which determined in the minds of the responsible statesmen the issue of war and peace.

The economic theories of imperialism are thus not supported by the experience of that historic period which they suppose to be intimately connected, if not identical, with imperialism, that is, the period of capitalism. Furthermore, the main period of colonial expansion which the economic theories tend to identify with imperialism precedes the age of mature capitalism and cannot be attributed to the inner contradictions of the decaying capitalist system. In comparison with the sixteenth, seventeenth, and eighteenth centuries, the colonial acquisitions of the nineteenth and twentieth centuries are small. The latest phase of capitalism even witnesses the liquidation of empire on a large scale in the form of the retreat from Asia of Great Britain, France, and the Netherlands.

The historic evidence is still more unfavorable to the contentions of the economic theories if one tests the theories against the evidence presented by the precapitalist processes of empire building. The policies which in ancient times led to the foundation of the Egyptian, Assyrian, and Persian empires were imperialistic in the political sense. So were the conquests of Alexander the Great and the policies of Rome in the last century before the Christian

Politics among Nations

era. The Arabian expansion in the seventh and eighth centuries showed all the earmarks of imperialism. Pope Urban II used the typical ideological arguments in support of an imperialistic policy when, in 1095, he expressed to the Council of Clermont the reasons for the First Crusade in these words: "For this land which you inhabit, shut in on all sides by the seas and surrounded by the mountain peaks, is too narrow for your large population; nor does it abound in wealth; and it furnishes scarcely food enough for its cultivators. Hence it is that you murder and devour one another, that you wage war, and that very many among you perish in civil strife."¹⁰ Louis XIV, Peter the Great, and Napoleon I were decidedly imperialists.

All these imperialisms of precapitalist times share with those of the capitalist period the tendency toward overthrowing the established power relations and putting in their stead the dominance of the imperialistic power. Yet those two periods of imperialism share also the subordination of economic objectives to political considerations.

Alexander the Great and Napoleon I, no more than Adolf Hitler, embarked on imperialistic policies for the purpose of personal gain or in order to escape the maladjustments of their economic systems. What they aimed at was exactly the same thing the captain of industry is aiming at when he tries to establish an industrial "empire" by adding enterprise to enterprise until he dominates his industry in a monopolistic or quasi-monopolistic manner. What the precapitalist imperialist, the capitalist imperialist, and the "imperialistic" capitalist want is power, not economic gain. The captain of industry is no more driven toward his "imperialistic goal" by economic necessity or personal greed than was Napoleon I. Personal gain and the solution of economic problems through imperialistic expansion are for all of them a pleasant afterthought, a welcome by-product, not the goal by which the imperialistic urge is attracted.

We have seen that imperialism is not determined by economics, capitalist or otherwise. We shall see now that capitalists per se are not imperialists. According to the economic theories and, more particularly, the "devil theory," capitalists use governments as their tools in instigating imperialistic policies. Yet the investigation of historic instances cited in support of the economic interpretation shows that in most cases the reverse relationship actually existed between statesmen and capitalists. Imperialistic policies were generally conceived by the governments who summoned the capitalists to support these policies. Thus historic evidence points to the primacy of politics over economics, and "the rule of the financier . . . over international politics" is indeed, in the words of Professor Schumpeter, "a newspaper fairytale, almost ludicrously at variance with facts."¹¹

Yet, far from being the instigators of imperialistic policies, capitalists as a group, that is, aside from certain individual capitalists, were not even enthusiastic supporters. The literature and policies of the groups and political parties representing the capitalist element in modern societies are a testimony

¹⁰ F. A. Ogg, editor, *A Source Book of Medieval History* (New York: American Book Company, 1907), p. 286.

¹¹ Joseph Schumpeter, *Business Cycles* (New York and London: McGraw-Hill Book Company, 1939), I, 405, note 1.

to the traditional opposition of the merchant and manufacturing classes to any foreign policy which, like imperialism, might lead to war. As Professor Viner has stated:

It was for the most part the middle classes who were the supporters of pacifism, of internationalism, of international conciliation and compromise of disputes, of disarmament—in so far as these had supporters. It was for the most part aristocrats, agrarians, often the urban working classes, who were the expansionists, the imperialists, the jingoists. In the British Parliament it was spokesmen for the “moneyed interests,” for the emerging middle classes in the northern manufacturing districts and for the “City” in London, who were the appeasers during the Napoleonic Wars, during the Crimean War, during the Boer War, and during the period from the rise of Hitler to the German invasion of Poland. In our own country it was largely from business circles that the important opposition came to the American Revolution, to the War of 1812, to the imperialism of 1898, and to the anti-Nazi policy of the Roosevelt administration prior to Pearl Harbor.¹²

From Sir Andrew Freepont in the *Spectator* at the beginning of the eighteenth century to Norman Angell's *The Great Illusion* in our time, it has been the conviction of the capitalists as a class and of most capitalists as individuals that “war does not pay,” that war is incompatible with an industrial society, that the interests of capitalism require peace and not war. For only peace permits those rational calculations upon which capitalist actions are based. War carries with it an element of irrationality and chaos which is alien to the very spirit of capitalism. Imperialism, however, as the attempt to overthrow the existing power relations, carries with it the inevitable risk of war. As a group then, capitalists were opposed to war; they did not initiate, and only supported with misgivings and under pressure, imperialistic policies which might lead, and many times actually did lead, to war.]

How was it possible that a body of doctrine, such as the economic theories of imperialism, which is to such an extent at variance with the facts of experience, could hold sway over the public mind? There are two answers. We have already pointed to the general tendency of the age to reduce political problems to economic ones.¹⁸ Of this fundamental error, the capitalists and their critics are equally guilty. The former expected from the development of capitalism, freed from the atavistic fetters of the precapitalist age and following only its own inherent laws, general prosperity and peace. The latter were convinced that these aims could be achieved only through the reform or the abolition of the capitalist system. Both camps looked to economic reme-

¹² Jacob Viner, “The Economic Problem,” *New Perspectives on Peace*, edited by George B. de Huszar (Chicago: The University of Chicago Press, 1944), p. 97. Professor Viner might also have cited the opposition of New York and New England merchants to the Civil War; cf. Philip S. Foner, *Business and Slavery: the New York Merchants and the Irrepressible Conflict* (Chapel Hill: The University of North Carolina Press, 1941).

Significant in this respect is also the report which the British Ambassador to Germany sent on the eve of the First World War, June 30, 1914, to his Foreign Office: “I hear in fact from all sides that the financial and industrial classes are dead against a war in any shape. . . .” *British Documents on the Origin of the War, 1898-1914* (London: His Majesty's Stationery Office, 1926), XI, 361.

¹⁸ See above, pp. 15 ff. Cf. also Hans J. Morgenthau, *Scientific Man vs. Power Politics* (Chicago: The University of Chicago Press, 1946), pp. 75 ff.

Politics among Nations

dies for political problems. Bentham advocated the emancipation of the colonies as the means of doing away with the imperialistic conflicts which lead to war. Proudhon, Cobden, and their disciples saw in tariffs the sole source of international conflicts and reasoned that peace lay in extending free trade.¹⁴

In our own time we have heard it said that since German, Italian, and Japanese imperialism was born of economic needs, these countries would have refrained from imperialistic policies had they received loans, colonies, and access to raw materials. Poor nations will go to war, so the argument runs, in order to escape economic distress; if the rich nations alleviate their economic afflictions, they will have no reason to go to war. In the classic age of capitalism both the adherents and the opponents of the capitalist system believed that the economic motives which seemed to determine the actions of businessmen were guiding the actions of all men.

The other reason for the ready acceptance of the economic interpretation of imperialism lies in its plausibility. What Professor Schumpeter has said of the Marxian theory of imperialism holds generally true: "A series of vital facts of our time seems to be perfectly accounted for. The whole maze of international politics seems to be cleared up by a single powerful stroke of analysis."¹⁵ The mystery of so threatening, inhuman, and often murderous a historic force as imperialism, the theoretical problem of defining it as a distinctive type of international politics, the practical difficulty, above all, of recognizing it in a concrete situation and of counteracting it with adequate means — all this is reduced to either the inherent tendencies or the abuses of the capitalist system. Whenever the phenomenon of imperialism presents itself for either theoretical understanding or practical action, the simple scheme will provide an almost automatic answer which puts the mind at ease

3. DIFFERENT TYPES OF IMPERIALISM

The true nature of imperialism as a policy devised to overthrow the status quo can best be explained by a consideration of certain typical situations which favor imperialistic policies and which, given the subjective and objective conditions necessary for an active foreign policy, will almost inevitably produce a policy of imperialism.

a) Three Inducements to Imperialism

When a nation is engaged in war with another nation, it is very likely that the nation which anticipates victory will pursue a policy which seeks a permanent change of the power relations with the defeated enemy. The nation will pursue this policy regardless of what the objectives were at the outbreak of the war. It is the objective of this policy of change to transform the relation between victor and vanquished which happens to exist at the end of the war into the new status quo of the peace settlement. Thus a war which was started by the victor as a defensive war, that is, for the maintenance of

¹⁴ See above, p. 16.

¹⁵ Joseph Schumpeter, *Capitalism, Socialism, and Democracy* (New York and London: Harper and Brothers, 1947), p. 51.

Imperialism

the prewar status quo, transforms itself with the approaching victory into an imperialistic war, that is, for a permanent change in the status quo.

The "Carthaginian Peace," by which the Romans changed their power relations with the Carthaginians permanently in their favor, has become the by-word for the kind of peace settlement which tends to perpetuate the relation between victor and vanquished as it exists at the conclusion of hostilities. The Treaty of Versailles and its companion treaties, terminating the First World War, had in the eyes of many observers a similar character. A policy which aims at a peace settlement of this kind must, according to our definition, be called imperialistic. It is imperialistic because it tries to replace the prewar status quo, when approximately equal or at least not thoroughly unequal powers oppose each other, with a postwar status quo where the victor becomes the permanent master of the vanquished.

However, this very status of subordination, intended for permanency, may easily engender in the vanquished a desire to turn the scales on the victor, to overthrow the status quo created by his victory, and to change places with him in the hierarchy of power. In other words, the policy of imperialism pursued by the victor in anticipation of his victory will be likely to call forth a policy of imperialism on the part of the vanquished. If he is not forever ruined or else won over to the cause of the victor, the vanquished will want to regain what he has lost and to gain more if possible.

The typical example of imperialism conceived as a reaction against the successful imperialism of others is German imperialism from 1935 to the end of the Second World War. The European status quo of 1914 was characterized by a concert of great powers consisting of Austria, France, Germany, Great Britain, Italy, and Russia. The victory of the Allies and the peace treaties created a new status quo which was the fruition of the imperialistic policies of France. This new status quo established the hegemony of France, exercised in alliance with most of the newly created nations of Eastern and Central Europe.

The German foreign policy from 1919 to 1935 operated seemingly within the framework of that status quo, while secretly preparing for its overthrow. It tried to win concessions for Germany, but it nevertheless accepted, at least for the time being and with mental reservations, the power relations established by the Treaty of Versailles. It did not openly challenge the power relations established by the Treaty of Versailles; rather, it aimed at adjustments which left the essence of those power relations intact. Such was particularly the character of the "policy of fulfillment," that is, fulfillment of the Treaty of Versailles, which the Republic of Weimar pursued. It was this attempt to improve the international position of Germany while accepting at least temporarily the status quo of Versailles which aroused the violent opposition of nationalists and Nazis. After the Nazis had come to power in 1933 and stabilized their regime domestically, they abrogated in 1935 the disarmament provisions of the Treaty of Versailles. In 1936, in violation of the same treaty, they occupied the Rhineland and declared void the demilitarization of the German territory adjacent to the German-French frontier. With these acts the imperialistic policy of Nazi Germany began in the open; for these acts were the first in a series which expressed Germany's resolution

Politics among Nations

no longer to accept the status quo of Versailles as basis for its foreign policy, but to work for the overthrow of that status quo.

Another typical situation that favors imperialistic policies is the existence of weak states or of politically empty spaces, which are attractive and accessible to a strong state. This is the situation out of which colonial imperialism grew. It is also the situation which made possible the transformation of the original federation of thirteen American states into a continental power. Napoleon's as well as Hitler's imperialism had partly this character, the latter's particularly in the period of the "blitzkrieg" of 1940. With the period of colonialism having come to an end and with two great power combinations opposing each other, imperialism growing out of the relations between strong and weak nations and out of the attractiveness of power vacuums seems to be less likely in the future than it has been in the past.

b) Three Goals of Imperialism

As imperialism grows out of three typical situations, so imperialism moves toward three typical objectives. The objective of imperialism can be the domination of the whole politically organized globe, that is, a world empire. Or it can be an empire or hegemony of approximately continental dimensions. Or it can be a strictly localized preponderance of power. In other words, the imperialistic policy may have no limits but those set by the power of resistance of the prospective victims. Or it may have geographically determined limits, such as the geographical boundaries of a continent. Or it may be limited by the localized aims of the imperialistic power itself.

The outstanding historic examples of unlimited imperialism are the expansionist policies of Alexander the Great, Rome, the Arabs in the seventh and eighth centuries, Napoleon I, and Hitler. They all have in common an urge toward expansion which knows no rational limits, feeds on its own successes, and, if not stopped by a superior force, will go on to the confines of the political world.¹⁶ This urge will not be satisfied so long as there remains anywhere a possible object of domination, that is, a politically organized group of men which by its very independence challenges the conqueror's lust for power. It is, as we shall see, exactly the lack of moderation, the aspiration to conquer all that lends itself to conquest, characteristic of unlimited imperialism, which in the past has been the undoing of the imperialistic policies of this kind. The only exception is Rome, for reasons which will be discussed later.¹⁷

¹⁶ Hobbes has given the classical analysis of this unlimited desire for power in the *Leviathan*, Chapter XI (Everyman's Library), pp. 49 ff. "So that in the first place, I put for a general inclination of all mankind, a perpetuall and restlesse desire of Power after power, that ceaseth onely in Death. And the cause of this, is not alwayes that a man hopes for a more intensive delight, than he has already attained to; or that he cannot be content with a moderate power: but because he cannot assure the power and means to live well, which he hath present, without the acquisition of more. And from hence it is, that Kings, whose power is greatest, turn their endeavours to the assuring it at home by Lawes, or abroad by Wars: and when that is done, there succeedeth a new desire; in some, of Fame from new conquest; in others, of ease and sensuall pleasure; in others, of admiration, or being flattered from excellence in some art, or other ability of the mind."

¹⁷ See below, pp. 403 ff.

The type of geographically determined imperialism is most clearly presented in the policies of European powers to gain a predominant position on the European continent. Louis XIV, Napoleon III, and William II are cases in point. The kingdom of Piedmont under Cavour aiming at the domination of the Italian peninsula, the different participants in the Balkan Wars of 1912 and 1913 aspiring to hegemony in the Balkan peninsula, Mussolini trying to make the Mediterranean an Italian lake—these are examples of geographically determined imperialism on a less than continental basis. The American policy of the nineteenth century consisting in the gradual expansion of American rule over the better part of the North American continent is primarily, but not exclusively, determined by the geographic limits of a continent; for the United States has not attempted to bring Canada and Mexico under its domination although it certainly would have been able to do so. Continental imperialism is here modified by its limitation to a localized section of the continent.

The same mixed type of imperialism constitutes the essence of American foreign policy toward the geographic unit of the Western Hemisphere. The Monroe Doctrine, by postulating for the Western Hemisphere a policy of the status quo with regard to non-American powers, erected a protective shield behind which the United States could establish its predominance within that geographic region. Within these geographic limits, however, American policy was not always uniformly imperialistic. In respect to the Central American republics and certain countries of South America it was outright imperialistic. But with regard to others, such as Argentina and Brazil, it sought rather to maintain the superiority of the United States which was the result of a kind of natural process rather than of a deliberate American policy. Even though the United States has had the power to impose its superiority upon these countries in form of actual hegemony, it chose not to do so. Here again we find within the general framework of a geographically limited policy a localized imperialism.

The prototype of localized imperialism is to be found in the monarchical policies of the eighteenth and nineteenth centuries. In the eighteenth century, Frederick the Great, Louis XV, Maria Theresa, Peter the Great, and Katherine II were the moving forces of this kind of foreign policy. In the nineteenth century, Bismarck was the master of this imperialistic policy which seeks to overthrow the status quo and to establish political preponderance within self-chosen limits. The difference between such a localized imperialistic policy, continental imperialism, and unlimited imperialism is the difference between the foreign policies of Bismarck, William II, and Hitler. Bismarck wanted to establish Germany's preponderance in Central Europe; William II, in all of Europe; Hitler, in the whole world. The traditional objectives of Russian imperialism, such as control of Finland, Eastern Europe, the Balkans, the Dardanelles, and Iran, are also of a localized nature.

The limits of this type of imperialism are not, as in the case of the geographically limited type, primarily a product of the objective facts of nature beyond which to go would be either technically difficult or politically unwise. On the contrary, they are primarily the result of a free choice among several alternatives one of which might be a policy of the status quo, another conti-

Politics among Nations

mental imperialism, a third localized imperialism. In the eighteenth century the third alternative recommended itself because the existing concert of powers, each of about the same strength, discouraged any attempt at continental imperialism. The experience of Louis XIV showed how hazardous such an attempt could be. Furthermore, eighteenth-century imperialism was motivated mainly by considerations of monarchical power and glory, not by the mass emotions of modern nationalism. These considerations operated within a common framework of monarchical traditions and European civilization which imposed upon the actors on the political scene a moral restraint necessarily absent in periods of religious or nationalistic crusades.

In the nineteenth century, the element of choice characteristic of the policy of localized imperialism is paramount in the history of Bismarck's foreign policy. First, he had to overcome the opposition of the Prussian conservatives who favored a policy of the status quo for Prussia as over against Bismarck's policy of localized imperialism aiming at hegemony within Germany. When victorious wars had made Bismarck's policy feasible, it had to be defended against those who now wanted to go beyond the limits which Bismarck had set for Prussian and later German hegemony. The dismissal of Bismarck by William II in 1890 marked the end of localized and the beginning of at least a tendency toward continental imperialism as the foreign policy of Germany.

c) Three Methods of Imperialism

Just as there are three types of imperialism with respect to the situations from which imperialism typically arises, and three types of imperialism from the point of view of its objectives, so a triple distinction is to be made as regards the typical means employed by imperialistic policies. Accordingly, we must distinguish between military, economic, and cultural imperialism. A widespread popular misconception connects these three concepts with the objectives of imperialism. This misconception has its origin in the economic theories of imperialism as well as in the neglect of the power element in international relations referred to above.¹⁸ Military imperialism seeks military conquest; economic imperialism, economic exploitation of other peoples; cultural imperialism, the displacement of one culture by another. Imperialism, however, always aims at the overthrow of the status quo, that is, the reversal of the power relations between the imperialist nation and its prospective victims. This immutable end is served by military, economic, and cultural means, either alone or in combination. It is with these means that we are dealing here.

MILITARY IMPERIALISM. The most obvious, the most ancient, and also the crudest form of imperialism is military conquest. The great conquerors of all times have by the same token also been the great imperialists. The great advantage of this method from the point of view of the imperialistic nation lies in the fact that the new power relations resulting from military conquest can as a rule be changed only by another war instigated by the vanquished na-

¹⁸ See above, pp. 13 ff.

tion, with the odds normally against the latter. Napoleon I might have relied upon the sole power of the ideas of the French Revolution to establish the hegemony of France in Europe and in the world, that is, he might have chosen cultural imperialism instead of military conquests. On the other hand, if he could make and hold military conquests, he would reach his imperialistic goal more quickly and derive from the process of conquering that maximum of personal satisfaction which victory in combat gives to the victor. Yet the very condition under which this statement is alone correct indicates the great drawback of military conquest as a method of imperialism — war is a gamble; it may be lost as well as won. The nation which starts wars for imperialistic ends may gain an empire and keep it, as Rome did. Or it may gain it and, in the process of trying to gain still more, lose it, as in Napoleon's case. Or it may gain it, lose it, and fall victim to the imperialism of others, as in the case of Nazi Germany and of Japan. Military imperialism is a gamble played for the highest stakes.

ECONOMIC IMPERIALISM. Economic imperialism is less obtrusive and also generally less effective than the military variety and is, as a rational method of gaining power, a product of modern times. As such, it is concomitant with the age of mercantilist and capitalist expansion. Its outstanding modern example is what is called "dollar imperialism." Yet it has also played its role in the history of British and French imperialism. In the British domination of Portugal since the beginning of the eighteenth century economic control has played an important part. British supremacy in the Arab world is the result of economic policies for which the term "oil diplomacy" is not misplaced. The predominant influence which France exercised in the period between the two world wars in countries such as Rumania was to a considerable extent based upon economic factors.

The common characteristic of the policies which we call economic imperialism is their tendency, on the one hand, to overthrow the status quo by changing the power relations between the imperialist nations and others and, on the other, to do so, not through the conquest of territory, but by way of economic control. If a nation cannot or will not conquer territory for the purpose of establishing its mastery over other nations, it can try to achieve the same end by establishing its control over those who control the territory. The Central American republics, for instance, are all sovereign states; they possess all the attributes of sovereignty and display the paraphernalia of sovereignty. Their economic life being almost completely dependent upon exports to the United States, these nations are unable to pursue for any length of time policies of any kind, domestic or foreign, to which the United States would object.

The nature of economic imperialism as an unobtrusive, indirect, but fairly effective method of gaining and maintaining domination over other nations is particularly striking where two rival imperialisms compete with economic means for control over the same government. The century-old competition between Great Britain and Russia for control of Iran, though carried on for a long time predominantly by military means, may serve as an example. Professor P. E. Roberts described this situation in Iran, then called Persia, before the First World War:

Politics among Nations

Russia presses on her from the north, Great Britain from the south, though the influence of the two powers is very different. Great Britain holds in her hands the bulk of the foreign trade of southern Persia, and claims a general control of the whole Asiatic coastline from Aden eastwards to Baluchistan. . . . Great Britain has never coveted territorial possessions. . . . The development of navigation on the Volga and the construction of the Transcaspian railway have given to Russia the bulk of the trade with northern Persia. But the commercial weapons of Russia are a monopoly and prohibition. She has laid an interdict upon the making of railroads in Persian territory, and has often opposed measures which might regenerate the country.¹⁹

Only "the commercial and political rivalry of Great Britain" seemed then, as does now that of the United States, to bar the way to the complete absorption of Iran into the Russian orbit.

To the factors prevalent before the First World War must be added the competitive exploitation of oil concessions and the competition for new ones in Northern and Southern Iran which exist today. During the period of economic and political rivalry between Great Britain and Russia in that region the foreign policies, and frequently also the domestic ones, of the Iranian governments have faithfully reflected the intensity of the economic, and sometimes military, pressures which the rival powers brought to bear. When Russia promised or granted economic advantages which Great Britain failed to match, or when Russia threatened to withdraw advantages it had granted, Russian influence would increase, and vice versa. Russia does not dare realize its territorial ambitions with regard to Iran. Great Britain has none. But both try to control the Iranian government which, in turn, controls oil fields as well as the road to India.

CULTURAL IMPERIALISM.²⁰ What we suggest calling cultural imperialism is the most subtle and, if it were ever to succeed by itself alone, the most successful of imperialistic policies. It aims not at the conquest of territory or at the control of economic life, but at the conquest and control of the minds of men as an instrument for changing the power relations between two nations. If one could imagine the culture and, more particularly, the political ideology, with all its concrete imperialistic objectives, of State A conquering the minds of all the citizens determining the policies of State B, State A would have won a more complete victory and would have founded its supremacy on more stable grounds than any military conqueror or economic master. State A would not need to threaten or employ military force or use economic pressure in order to achieve its ends; for that end, the subservience of State B to its will, would have already been realized by the persuasiveness of a superior culture and a more attractive political ideology.

This is, however, a hypothetical case. In actuality, cultural imperialism

¹⁹ *Cambridge Modern History* (Popular Edition), XII, 491.

²⁰ What we describe under this heading goes frequently under the name of ideological imperialism, the term "ideological" referring particularly to the contest of political philosophies. Two reasons, however, seem to make it advisable to use the term "cultural" instead. On the one hand, the term "cultural" comprises all kinds of intellectual influences, political and otherwise, which serve as means for imperialistic ends. On the other hand, we are using the term "ideological" in Chapter V in its specific sociological sense, and it would only make for confusion if we would use the same term here in its general popular meaning.

falls short of a victory so complete that other methods of imperialism would be superfluous. The typical role which cultural imperialism plays in modern times is subsidiary to the other methods. It softens up the enemy, it prepares the ground for military conquest or economic penetration. Its typical modern manifestation is the fifth column, and one of its two outstanding modern successes is to be found in the operations of the Nazi fifth columns in Europe before the outbreak and at the beginning of the Second World War. Its success was most spectacular in Austria where in 1938 a Nazi-minded government invited the German troops to occupy their country. Its success was still considerable in France and Norway where a number of influential citizens, inside and without the government, had become "Quislings," that is, had been converted to the Nazi ideology and its international objectives. It is hardly an exaggeration to say that these countries were already partly conquered by means of cultural imperialism before military conquest finished the task. Great Britain, by interning at the outbreak of the Second World War all known Nazis and Nazi sympathizers within its borders, paid tribute to the danger which Nazi methods of cultural penetration presented for the prospective victims of German imperialism.

The other outstanding example of cultural imperialism in our time, antedating and surviving the Nazi fifth column, is the Communist International. Directed officially from Moscow, it guides and controls the Communist parties in all countries and sees to it that the policies pursued by the national Communist parties conform with the foreign policy of the Soviet Union. To the extent that Communist parties gain influence in particular nations, the influence of the Soviet Union over these nations increases, and where Communist parties gain control of national governments, the Russian government, controlling the Communist parties, controls these national governments.

The struggle for the control of Germany is instructive in this respect. The main instrument of the Soviet Union in this struggle was the Communist party, called Socialist Unity party, in the Russian zone of occupation. Through victory in elections, this party was to have transformed the temporary military power of the Soviet Union in its zone into a permanent hegemony. With the defeat of the Communist party in a number of elections, the cultural phase of Russian imperialism in Germany came to an at least temporary end. The Soviet Union had to devise other methods to reach the imperialistic goal of the domination of Germany, or, prompted by the failure of the means employed, had to change the goal itself.

The cultural imperialism of totalitarian governments is well disciplined and highly organized; for these governments are able, because of their totalitarian character, to exert strict control and guiding influence over the thoughts and actions of their citizens and foreign sympathizers. While the technique of cultural imperialism has been perfected by the totalitarians and has been forged into the effective political weapon of the fifth column, the use of cultural sympathy and political affinities as weapons of imperialism is almost as old as imperialism itself. The history of ancient Greece and of Italy in the period of the Renaissance is replete with episodes in which imperialistic policies were executed through association with political sympa-

Politics among Nations

thizers in the enemy ranks rather than through military conquests. In modern times religious organizations, associated or identified with governments, have played an important role in imperialistic policies of a cultural character. Typical in this respect are the imperialistic policies of Czarist Russia which used the dual position of the Czar as head of the Russian government and of the Orthodox Church for the purpose of extending the power of Russia to the followers of the Orthodox faith in foreign countries. That Russia was able in the nineteenth century to succeed Turkey as the preponderant power in the Balkans is largely due to the cultural imperialism which used the Orthodox Church as a weapon of Russian foreign policy.

In the secular field, *la mission civilisatrice* of France has been a potent weapon of French imperialism. The deliberate use of the attractive qualities of French civilization for the purposes of French foreign policy was before the First World War one of the cornerstones of French imperialism in the countries of the Eastern Mediterranean area. The wave of public sympathy throughout the world, which came to the aid of France in both world wars, was the fruit of cultural imperialism, which in turn strengthened the French military imperialism of the later, victorious years of both world wars. Cultural imperialism in the form of the diffusion of a national culture is incomparably less mechanical and disciplinary, but not necessarily less effective, than the totalitarian kind. While the latter makes use primarily of the affinities of political ideology, the former impresses the intellectually influential groups of a foreign country with the attractive qualities of a civilization until these groups tend to find the political objectives and methods of that civilization equally attractive.

We have already pointed out that cultural imperialism generally plays a role subsidiary to the military and economic varieties. Similarly, while economic imperialism sometimes stands by itself, it frequently supports military policies. On the other hand, while military imperialism is able to conquer without the support of nonmilitary methods, no dominion can last which is founded upon nothing but military force. Thus the conqueror will not only prepare for military conquests by economic and cultural penetration. He will also found his empire not upon military force alone, but primarily upon the control of the livelihood of the conquered and upon the domination of their minds. And it is in that most subtle, yet most important, task that, with the exception of Rome, all the great imperialists, from Alexander to Napoleon and Hitler, have failed. Their failure to conquer the minds of those whom they had conquered otherwise proved to be the undoing of their empires. The ever renewed coalitions against Napoleon, the revolts of the Poles against the Russians throughout the nineteenth century, the struggle of the underground against Hitler, and the fight of Ireland and of India for freedom from British rule are the classic examples in modern times of that ultimate problem which few imperialistic policies have been able to solve.

4. HOW TO DETECT AND COUNTER AN IMPERIALISTIC POLICY

The preceding considerations lead to the fundamental question which confronts the public officials responsible for the conduct of foreign affairs as well as citizens trying to form an intelligent opinion on international issues. This question concerns the character of the foreign policy pursued by another nation and, in consequence, the kind of foreign policy which ought to be adopted with regard to it. Is the foreign policy of the other nation imperialistic, or is it not? In other words, does it seek to overthrow the existing distribution of power, or does it only contemplate adjustments within the general framework of the existing status quo? The answer to that question has determined the fate of nations, and the wrong answer has often meant deadly peril or actual destruction; for upon the correctness of that answer depends the success of the foreign policy derived from it. While it would be fatal to counter imperialistic designs with measures appropriate to a policy of the status quo, it would be only a little less risky to deal with a policy seeking adjustments within the status quo as though it were imperialistic. The classic example of the former error is the appeasement of Germany in the late thirties. The other error has been influential in the formation of the foreign policies of the great European powers in the decades before the outbreak of the First World War.

a) Appeasement

Appeasement is a foreign policy which attempts to do with respect to imperialism what compromise does with respect to a policy of the status quo. It is the transfer of a policy of compromise from a political environment favorable to the preservation of the status quo, where it belongs, to an environment exposed to imperialistic attack, where it does not belong. One might say that appeasement is a corrupted policy of compromise, made erroneous by mistaking a policy of imperialism for a policy of the status quo. It is important to note, in view of the contemporary tendency to use the term "appeasement" indiscriminately as a term of opprobrium, that appeasement and imperialism are logically correlated. In other words, a policy of appeasement on the one side presupposes a policy of imperialism on the other side. If we say that State A pursues with respect to State B a policy of appeasement, we are at the same time saying that State B pursues with respect to State A a policy of imperialism. If the latter statement is incorrect, the former is meaningless.

The appeaser sees in the successive demands of the imperialistic power rationally limited objectives which in themselves are compatible with the maintenance of the status quo and must be disposed of either on their intrinsic merits or by way of compromise. His error lies in not seeing that the successive demands, far from being satisfied with obtaining their professed objectives, are but the links of a chain at the end of which stands the overthrow of the status quo. The conciliation of antagonistic policies on the basis of

Politics among Nations

legal or moral principles or through a diplomatic bargain is indeed the great task of a diplomacy which operates on both sides within the recognized limits of the status quo. Since both sides accept the existing distribution of power, both sides can afford to settle their differences either on the basis of principle or through compromise; for whatever the settlement may be, it will not affect the basic distribution of power between them.

The situation is, however, different when one or both sides have imperialistic designs, that is, to bring about a fundamental change in the existing distribution of power. Then the settlement of the respective demands on the basis of legal or moral principles or through bargaining methods, in disregard of the influence the settlement might have upon the distribution of power, amounts to a piecemeal change in the power relations in favor of the imperialistic nation. For the latter will always be favored by compromise and will be careful in choosing the grounds for its demands so that principle will favor it, too. Ultimately, these piecemeal changes will add up to the reversal of the power relations in favor of the imperialistic nation. The imperialistic nation will have won a bloodless, yet decisive, victory over an opponent who did not know the difference between compromise and appeasement.

Germany started its imperialistic policies openly in 1935 with the repudiation of the disarmament provisions of the Treaty of Versailles, pointing to the failure of the other nations to disarm and to the increase in French and Russian armaments. Taken by itself and in disregard of an ulterior objective, the argument was not without merit in the light of the legal principle of equality. Apart from paper protests and paper alliances, the only tangible reaction to this first German step on the road to empire was the conclusion three months later of the Anglo-German Naval Agreement in which Great Britain conceded to Germany a naval force of not more than 35 per cent that of Great Britain. Both the reoccupation of the Rhineland by Germany in 1936 and its denunciation of the international control of its waterways later in the same year found support in the legal principle of equality, if one accepted the professed rational limits of the demands as the actual ones. The annexation of Austria in 1938 could easily be defended by the principle of national self-determination which had also been one of the professed war aims of the Allied powers in the First World War.

Later in 1938 Germany demanded the German parts of Czechoslovakia. The Munich settlement granted the German demands. When Hitler, shortly before the settlement of Munich, declared that the German parts of Czechoslovakia were the last territorial demands Germany had to make in Europe, he was really saying that the annexation of these territories was an end in itself, self-contained within its own rational limits. He pretended that German policy operated within the general framework of the European status quo and was not intent upon overthrowing it, and that the other European powers ought to view German foreign policy in that light and deal with it correspondingly. It was only by the end of March 1939, five months before the outbreak of the Second World War, that the annexation of the whole of Czechoslovakia and the territorial demands on Poland convinced the Western powers that what had appeared to be a policy of the status quo had really

been from the beginning a policy of imperialism, imperialism of continental, if not world, dimensions.

At that moment, the distribution of power in Europe was already changed in favor of Germany. It was changed to such an extent that a further increase in German power could not be prevented short of war. Germany had become strong enough to challenge openly the status quo of Versailles, and the prestige, that is, the reputation for power, of the nations identified with the order of Versailles had sunk so low that they were unable to defend what was left of the status quo by mere diplomatic means. They could either surrender or go to war. Thus the appeasers of 1938 became either the Quislings (if they deemed resistance to German imperialism hopeless) or the heroes of 1939-45 (if they thought that resistance was morally required regardless of the outcome or that it had even a chance to succeed). The final catastrophe and the tragic choices with which that catastrophe confronted the actors on the international scene were predetermined by that initial error which mistook a policy of imperialism for a policy of the status quo.

b) Fear

The other fundamental error into which those responsible for the conduct of foreign affairs are most likely to fall is the reverse of the one thus far discussed. It mistakes a policy of the status quo for a policy of imperialism. By doing so, State A resorts to measures, such as armaments, fortifications, alliances, with respect to State B. The latter, in turn, resorts to countermeasures, for it now sees State A embark upon a policy of imperialism. These countermeasures strengthen the initial misapprehension, on the part of State A, of State B's policies, and so forth. Ultimately, either both countries correct their errors with regard to their respective policies or else the ever increasing mutual suspicions, feeding upon each other, end in war. Out of an initial error there develops a vicious circle where two or more nations, each only seeking to preserve the status quo, but each convinced of the imperialistic designs of the others, find support for their own errors of judgment and action in the errors of the others. In such a situation nothing but an almost superhuman effort will deflect the trend of events from a catastrophic denouement.

The history of European diplomacy between the Franco-German War of 1870 and the outbreak of the First World War in 1914 illustrates this situation. After the victorious conclusion of the War of 1870 and the foundation of the German Empire, German foreign policy was mainly defensive. It was concerned with the maintenance of the position which Germany had acquired in Europe and with the danger, Bismarck's famous *chauchemar des coalitions*, that a hostile coalition, especially between France and Russia, might challenge that position. The Triple Alliance between Germany, Austria, and Italy was the instrument of that defensive policy. It was served also by the Reinsurance Treaty with Russia in which Russia and Germany pledged each other neutrality if either became involved in war with a third power.

After the dismissal of Bismarck in 1890, William II decided to let the Reinsurance Treaty lapse, primarily because of the fear that its continuation

Politics among Nations

might alienate Austria and thus destroy the Triple Alliance. Russia then (in 1891 and 1894) entered into agreements with France which were defensive in character and obviously inspired by fear of the intentions of the Triple Alliance. The provisions of the Military Convention of 1894, in particular, anticipated the possible transformation of the Triple Alliance from a defensive into an imperialistic instrument. Thus the Convention was to remain in force as long as the Triple Alliance. The main provisions of the Convention made the following stipulations: If France were attacked by Germany or by Italy supported by Germany, Russia would give military aid to France. France would do the same in respect to Russia if the latter were attacked by Germany or by Austria supported by Germany. In case of the mobilization of the forces of the Triple Alliance, France and Russia would mobilize their forces without delay.

First, the fear of hostile alliances led to the formation of the Triple Alliance. Then, the fear of the latter's dissolution led to the severance, on the part of Germany, of the friendly relations with Russia. Finally, the fear of the intentions of the Triple Alliance brought about the Franco-Russian Alliance. It was the mutual fears of these two defensive alliances and the general insecurity created by the erratic character of the imperialistic utterances of William II which inspired the diplomatic maneuvers during the two decades before the First World War. These maneuvers sought either new combinations destructive of existing alignments or the support of powers, thus far aloof, for the existing alliances. In the end, the general conflagration in 1914 was made inevitable by the fear that the other side would change the power relations decisively in its favor if not forestalled by such a change in one's own favor. In the two antagonistic blocs, Russia and Austria especially were animated by this fear. The fear of the other's suspected imperialism bred imperialism in reaction, which, in turn, gave substance to the original fear.

c) Five Difficulties of the Problem

Appeasement, the attempt to compromise with an imperialism not recognized as such, and the fear which creates imperialism where there is none — these are the two wrong answers, the two fatal mistakes which an intelligent foreign policy must try to avoid. Such an intelligent foreign policy, which recognizes imperialism where it exists and determines its specific nature, is confronted with five difficulties, and they are all of a formidable character.

The first and most fundamental difficulty has been pointed out by Bukharin, the foremost exponent of the Communist doctrine from Lenin's death to the great purges in the mid-thirties. He tried to prove the absurdity of a noneconomic explanation of imperialism by summarizing it thus: "Imperialism is a policy of conquest. But not every policy of conquest is imperialism."²¹ The statement is indeed correct and squares with what we have said previously about the distinction between a policy of conquest operating

²¹ N. I. Bukharin, *Imperialism and World Economy* (New York: International Publishers, 1929), p. 114.

within the existing status quo and one seeking to overthrow it.²² To make this distinction in a concrete situation presents a formidable difficulty. How was one to know with any degree of certainty what Hitler's ultimate objectives were? From 1935 on, he made demand after demand, each of which in itself could be fully reconciled with a policy of the status quo, yet each of which might be a stepping-stone on the road to empire. The nature of the individual steps in themselves was ambiguous and, therefore, did not reveal the actual nature of the policy of which they formed the elements. Where could one, then, have found an answer to our question?

One might have found it, however tentative and open to doubt, in two of the three typical situations which we said before favored imperialistic policies. The desire to overthrow the status quo of the Treaty of Versailles had been from the very beginning one of the main points of the Nazi program which in 1933 became the official program of the German government. In view of this objective, one might have been able to foresee that the German government would pursue a foreign policy seeking its realization as soon as it had a chance to do so, that is, as soon as the nations identified with the status quo of the Treaty of Versailles were no longer able or willing to defend that status quo effectively.

This initial and fundamental difficulty is aggravated by the fact that a policy which starts out seeking adjustments within the existing distribution of power may change its character either in the course of its success or in the process of its frustration. In other words, the ease with which the original objectives are reached within the established distribution of power may suggest to the expanding nation that it is dealing with weak or irresolute antagonists and that a change in the existing power relations can be achieved without great effort or risk. Thus the appetite may come with the eating, and a successful policy of expansion within the status quo may overnight transform itself into a policy of imperialism. The same may be true of an unsuccessful policy of expansion within the status quo. A nation frustrated in its limited objectives, which do not seem to be attainable within the existing power relations, concludes that it must change these power relations if it is to make sure that it gets what it wants.

Where a policy is couched in purely territorial terms, the nature of the territorial objectives will sometimes indicate the nature of the policy pursued. The objective may, for instance, be a strategic point, the acquisition of which may in itself change the power relations in that particular region. No such help can be expected and, therefore, an additional difficulty must be met where a foreign policy uses mainly the vehicles of economic or cultural penetration. These methods, too, are ambiguous in view of the character of the policy which they serve, but their ambiguity is much greater than that of the military method which has defined territorial objectives. Economic and cultural expansion are generally without a clearly defined locale. They address themselves to a wide variety of ill-defined persons. And, furthermore, they are practiced on a wide scale by an indifferent number of nations. To identify economic or cultural expansion as instruments of imperialism in

²² See above, pp. 25 ff.

Politics among Nations

contradistinction to identical policies which have their ends in themselves is another difficult task. Here again reference to the typical situations favorable to imperialistic policies will be of help.

The active economic policies which Switzerland has been pursuing in the international sphere have never had an imperialistic tinge. British foreign-trade policies at times have had an imperialistic character with respect to certain countries. Today their end is in the main purely economic, that is, they try to obtain for the inhabitants of the British Isles the necessities of life. They aim at economic survival through favorable trade balances, not at the maintenance or acquisition of political power over foreign nations. It is only with regard to the Near East, certain regions of Western Europe, and Germany that British economic policies are subordinated to political considerations. Some of these political considerations might have, or under certain conditions will acquire, an imperialistic character.

The cultural penetration of Spanish-America by Spain was generally bound to be without imperialistic significance; for the military weakness of Spain in relation to the United States forbade any thought of changing the power relations in Latin America in Spain's favor. The cultural mission of France has been in certain countries and at certain times an end in itself. Under different circumstances and in other countries it has been subordinated to imperialistic aims. Here, too, the character of economic and cultural expansion may change with a change in the political situation. When the opportunity beckons, the "reservoir of good will" or a preponderant position in the foreign trade of another country, which a nation has acquired as ends in themselves, may suddenly become sources of political power and potent instruments in the struggle for power. But when circumstances change again they may lose that quality just as suddenly.

When all these difficulties have been overcome and a foreign policy has been correctly identified as imperialistic, yet another difficulty presents itself. It concerns the kind of imperialism with which one has to deal. A successful localized imperialism may find in its success an incentive to spread wider and wider until it becomes continental or world-wide. More particularly, a country may find it necessary, in order to stabilize and secure a local preponderance, to acquire preponderance of power on an ever greater scale, and it may feel fully secure only in a world-wide empire. There is frequently in imperialism a dynamism, rationalized in aggressive or defensive terms, which proceeds from a limited region to a continent and from there to the world. The Macedonian Empire under Philip and Alexander and the Napoleonic imperialism were of this kind. On the other hand, a policy of world-wide imperialism, opposed by superior force, may retreat to a geographically determined region or be satisfied with local preponderance. Or it may lose its imperialistic tendencies altogether and transform itself into a policy of the status quo. The development from geographically determined to localized imperialism and from there to the permanent loss of imperialistic tendencies altogether can be traced in the history of Swedish imperialism in the seventeenth and eighteenth centuries.

Thus the evaluation of imperialistic tendencies and, consequently, of the policies countering them is never definitive. Both policies and counterpolicies

Imperialism

are ever subject to re-evaluation and reformulation. However, the frames of foreign policy are always exposed to the temptation to take a particular pattern of imperialistic expansion or of any other type of foreign policy as permanent and to pursue a foreign policy adapted to that pattern even when that pattern has changed. Yet a world-wide imperialism requires counter-measures different from those which are adequate for one that is localized, and a nation which counters the latter with measures appropriate to the former will bring on the very dangers which it tries to avoid. In this necessity to recognize quickly a change in the imperialistic policy of another nation lies another difficulty and, in the failure to adapt one's own foreign policy quickly to such change, another source of error.

Finally, imperialism poses a problem which it shares with all foreign policy, presenting it, however, in a particularly acute manner, that is, the detection of the true nature of a foreign policy behind its ideological disguises. The difficulties of recognition inherent in imperialism itself are augmented by the fact that a foreign policy rarely presents itself for what it is, and a policy of imperialism almost never reveals its true face in the pronouncements of its representatives. The reasons why this must be so and the typical shapes these ideologies take will be discussed in Chapter V of this book. How difficult it is to distinguish between the appearance of a foreign policy and its essence will become apparent in the course of that discussion.

CHAPTER IV

The Struggle for Power: Policy of Prestige

The policy of prestige has rarely been recognized in modern political literature for what it is: the third of the basic manifestations of the struggle for power on the international scene. The reasons for this neglect are twofold. The policy of prestige has used as one of its main vehicles the aristocratic forms of social intercourse as practiced in the diplomatic world. The diplomatic world, with its ceremonial rules, its quarrels about rank and precedence, and its empty formalisms, is the very antithesis of the democratic way of life. Even those who were not fully persuaded that power politics was nothing but an aristocratic atavism were inclined to see in the policy of prestige as practiced by diplomats an anachronistic game, frivolous and farcical and devoid of any organic connection with the business of international politics.

Prestige, in contrast to maintenance and acquisition of power, is but rarely an end in itself. More frequently, the policy of prestige is one of the instrumentalities through which the policies of the status quo and of imperialism try to achieve their ends. Thus subordination to the latter as a means to an end could easily lead to the conclusion that it was not important and did not deserve systematic discussion.

Actually, the policy of prestige, however exaggerated and absurd its uses may have been at times, is as intrinsic an element of the relations between nations as the desire for prestige is of the relations between individuals. Here again it becomes obvious that international and domestic politics are but different manifestations of one and the same thing. In both spheres, the desire for social recognition is a potent dynamic force determining social relations and creating social institutions. The individual seeks confirmation, on the part of his fellows, of the evaluation he puts upon himself. It is only in the tribute which others pay to his goodness, intelligence, and power that he becomes fully aware of, and can fully enjoy, what he deems to be his superior qualities. It is only through his reputation for excellence that he can gain the measure of security, wealth, and power which he regards to be his due. Thus, in the struggle for existence and power, which is, as it were, the raw

material of the social world, what others think about us is as important as what we actually are. The image in the mirror of our fellows' minds, that is, our prestige, rather than the original, of which the image in the mirror may be but the distorted reflection, determines what we are as members of society.

It is, then, a necessary and important task to see to it that the mental picture which the other members of society form of one's position in society at least represents faithfully the actual situation, if it does not excel it. This is exactly what the policy of prestige is about. Its purpose is to impress upon the other nations the power one's own nation actually possesses or which it believes, or wants the other nations to believe, it possesses. Two main instrumentalities serve this purpose: diplomatic ceremonial in the widest meaning of the term, and the display of military force.

I. DIPLOMATIC CEREMONIAL

Two episodes from the life of Napoleon show clearly the symbols through which the power position of a ruler, representing a nation, expresses itself in ceremonial forms. One shows Napoleon at the summit of his power, the other indicates that he has left that summit behind.

In 1804, when Napoleon was about to be crowned Emperor by the Pope, each of the two rulers had a vital interest in demonstrating his superiority over the other. Napoleon was successful in asserting his superiority, not only by putting the crown on his head with his own hands instead of letting the Pope do it, but also by a ceremonial device which the Duke of Rovigo, one of Napoleon's generals and minister of police, reports in his memoirs:

He went to meet the Pope on the road to Nemours. To avoid ceremony, the pretext of a hunting-party was assumed; the attendants, with his equipages, were in the forest. The Emperor came on horseback and in a hunting-dress, with his retinue. It was at the half-moon on the top of the hill that the meeting took place. There the Pope's carriage drew up; he got out at the left door in his white costume: the ground was dirty; he did not like to step upon it with his white silk shoes, but was obliged to do so at last.

Napoleon alighted to receive him. They embraced; and the Emperor's carriage, which had been purposely driven up, was advanced a few paces, as if from the carelessness of the driver; but men were posted to hold the two doors open: at the moment of getting in, the Emperor took the right door, and an officer of the court handed the Pope to the left, so that they entered the carriage by the two doors at the same time. The Emperor naturally seated himself on the right; and this first step decided without negotiation upon the etiquette to be observed during the whole time that the Pope was to remain at Paris.¹

The other episode occurred in 1813 in Dresden, after the defeat in Russia, when Napoleon was threatened by a coalition of all of Europe, a coalition which shortly afterward would inflict upon him the disastrous defeat of Leipzig. In an interview lasting nine hours, Napoleon tried to restrain the

¹ *Memoirs of the Duke of Rovigo* (London, 1828), I, Part II, 73.

Politics among Nations

Austrian Chancellor, Metternich, from joining the coalition against him. Metternich treated Napoleon as a doomed man, while Napoleon acted like the master of Europe, which he had been for a decade. After a particularly stormy exchange, Napoleon, as if to test his superiority, dropped his hat, expecting the spokesman of the hostile coalition to pick it up. When Metternich feigned not to see it, it must have become clear to both men that a decisive change had occurred in the prestige and power of the victor of Austerlitz and Wagram. Metternich summed up the situation when he told Napoleon at the end of the discussion that he was sure Napoleon was lost.

The relations between diplomats lend themselves naturally as instruments for a policy of prestige, for diplomats are the symbolic representatives of their respective countries.² The respect shown to them is really shown to their countries; the respect shown by them is really shown by their countries; the insult they give or receive is really given or received by their countries. History abounds with examples illustrating these points and the importance attributed to them in international politics.

In most courts it was the custom to have foreign ambassadors introduced to the sovereign by special officials while royal ambassadors were introduced by princes. When in 1698 Louis XIV had the Ambassador of the Republic of Venice introduced by the Prince of Lorraine, the Grand Council of Venice asked the French Ambassador to assure the King that the Republic of Venice would be forever grateful for that honor and the Council sent a special letter of thanks to Louis XIV. Through that gesture France indicated that it regarded the Republic of Venice to be as powerful as a kingdom, and it was for that new prestige that Venice showed its gratitude. At the papal court the Pope used to receive the diplomatic representatives of different types of states in different halls. Ambassadors of crowned heads and of Venice were received in the *Sala Reggia*, the representatives of other princes and republics in the *Sala Ducale*. The Republic of Genoa is said to have offered the Pope millions in order to have its representatives received in the *Sala Reggia* instead of in the *Sala Ducale*. The Pope, however, refused to grant the request because of the opposition of Venice which did not want to be treated on equal terms with Genoa. Equality of treatment would have meant equality of prestige, that is, reputation for power, and to this the state superior in prestige could not consent.

At the end of the eighteenth century, it was still the custom at the court of Constantinople that ambassadors and members of their suites, who represented themselves to the Sultan, were grabbed by the arms by court officials and their heads bent down. After the customary exchange of speeches between the ambassador and the Wesir, the court officials exclaimed: "Praise be to the Eternal that the infidels must come and give homage to our gloriously brilliant sceptre." The humiliation of the representatives of foreign countries was intended to symbolize the inferiority in power of the countries they represented.

Under President Theodore Roosevelt, all diplomatic representatives were received together on the first of January in order to present their congratula-

² For the different functions of diplomats, see below, Chapter XXVIII.

tions to the President. President Taft changed the arrangement and ordered that ambassadors and ministers be received separately. When the Spanish Minister, who had not been informed of this change, appeared on January 1, 1910, at the White House for the reception of the ambassadors he was refused admission. Whereupon the Spanish government recalled the minister and protested to the government of the United States. A nation which had just lost its empire and passed to the rank of a third-rate power insisted at least upon the prestige commensurate with its former greatness.

In 1946, when the Foreign Minister of the Soviet Union was seated at a victory celebration in Paris in the second row, while the representatives of other great powers sat in the first, he left the meeting in protest. A nation which for long had been a pariah in the international community had attained the unquestioned position of a great power and insisted upon the prestige due to its new status. Since, at the Potsdam Conference of 1945, Churchill, Stalin, and Truman were unable to agree on who should enter the conference room first, they entered through three different doors at the same time. These three political leaders symbolized the respective power of their nations. Consequently, the precedence accorded to one of them would have given his nation a prestige of superiority over the other two which the latter were not willing to concede. Since they claimed equality of power, they were bound to be concerned with upholding the prestige in which that equality found its symbolic expression.

The policy of prestige as the policy of demonstrating the power a nation has or thinks it has, or wants other nations to believe it has, finds a particularly fruitful field in the choice of a locality for international meetings. When many antagonistic claims compete with each other and cannot be reconciled through compromise, the meeting place is frequently chosen in a country which does not participate in the competition for prestige. For this reason, The Hague in the Netherlands and Geneva in Switzerland have been favored meeting places for international conferences. Frequently, the shift from one favorite meeting place to another symbolizes a shift in the preponderance of power. During the better part of the nineteenth century, most international conferences were held in Paris. But the Congress of Berlin of 1878, held in the capital of the re-established German Empire after its victory over France, demonstrated to all the world Germany's new prestige of being the preponderant power on the European continent. Originally, the Soviet Union opposed the choice of Geneva as headquarters of the United Nations; for Geneva, the former headquarters of the League of Nations, was symbolic of the low point in Russian prestige in the period between the two world wars. When the distribution of power within the United Nations, meeting in New York, showed the Soviet Union to be in a permanent minority, confronted with a stable Anglo-American bloc, it advocated the transfer of the headquarters of the United Nations to Geneva, which carried no symbolic reference to Anglo-American supremacy.

Normally a nation which has a preponderance of power in a particular field or region insists that international conferences dealing with matters concerning that field or region meet within, or at least close to, its territory. Thus most international conferences dealing with maritime questions have

Politics among Nations

been held in London. International conferences concerned with Japan have met either in Washington or in Tokyo. However, most international conferences concerned with the future of Europe after the Second World War have been held either on Russian territory, such as Moscow and Yalta, or in territory occupied by the Soviet Union, such as Potsdam, or in the proximity of Russian territory, such as Teheran. Yet, by the end of 1947, the political situation had changed to such an extent that President Truman could declare with considerable emphasis that he would meet Mr. Stalin nowhere but in Washington.³

2. DISPLAY OF MILITARY FORCE

Besides the practices of diplomacy, the policy of prestige uses military demonstrations as means to achieve its purpose. Since military strength is the obvious measure of a nation's power, its demonstration serves to impress the others with that nation's power. Military representatives of foreign nations are, for instance, invited to peacetime army and navy maneuvers, not in order to let them in on military secrets, but in order to impress them and their governments with the military preparedness of the particular nation. The invitation of foreign observers to the two atomic bomb tests in the Pacific in 1946 was intended to fulfill a similar purpose. The foreign observer was, on the one hand, to be impressed by the naval might of the United States and with American technological achievements. "Twenty-one observers from the United Nations Atomic Energy Control Commission," reported the *New York Times*, ". . . agreed today that the United States was bombing a group of ships larger than many of the world's navies."⁴ On the other hand, the foreign observer was to see for himself what the atomic bomb could do above and under water and how superior in military strength a nation which had the monopoly of the atomic bomb was bound to be in comparison with nations which did not have it. The combination of these factors would give the United States the prestige of being the most powerful nation on earth.

Because of the high mobility of navies, which are able to bring the flag and the power of a nation to the four corners of the globe, and because of the great impressiveness of their appearance, naval demonstrations have in the past been a favorite instrument of the policy of prestige. The visit in 1891 of the French fleet to the Russian port of Kronstadt and the return visit in 1893 of the Russian fleet to the French port of Toulon mark a turning point in the political history of the world; for these mutual visits demonstrated to the world a political and military solidarity between France and Russia which was not long in crystallizing into a political and military alliance. The periodical dispatch, on the part of the great maritime powers, of naval squadrons to the ports of the Far East demonstrated to the peoples of that region the superiority of Western power. The United States has from time to time sent

³ *New York Times*, December 19, 1947, p. 1.

⁴ July 1, 1946, p. 3.

Policy of Prestige

warships to Latin-American ports in order to remind the nations concerned that in the Western Hemisphere American naval power is supreme.

In colonial or semicolonial regions, whenever the claims of a maritime power were challenged either by the natives or by competing powers, these nations would dispatch one or several warships to the region as symbolic representatives of the power of the country. A famous example of this kind of policy of prestige is the visit which William II paid in 1905 on board a German warship to Tangier, the capital of Morocco, for the purpose of counteracting French claims with regard to that state. The Mediterranean cruises which American naval squadrons have been making since 1946 to Italian, Greek, and Turkish ports, are the unmistakable reply to Russian aspirations in that region. The selection in 1946 of the biggest battleship and of the most modern aircraft carrier of the American fleet demonstrated to the Soviet Union as well as to the nations of the eastern Mediterranean the air and naval power which the United States possesses and which it was resolved to use in defense of the status quo in the eastern Mediterranean.

The most drastic form of the military type of the policy of prestige is partial or total mobilization. Mobilization as an instrument of the policy of prestige may be obsolete today, since the war of the future will in all probability require total preparedness at all times. In the past, however, and still in 1938 and 1939, the calling to the colors either of certain classes of the reserves or of all those subject to military service has been a potent instrument of the policy of prestige. When, for instance, in July 1914, Russia mobilized its army, followed by the mobilization of the Austrian, German, and French forces, and when France and Czechoslovakia mobilized their armies in September 1938, and France its army again in March and September 1939, the purpose was always to demonstrate to friend and foe alike one's own military strength and one's resolution to use that strength in support of one's own political ends.

Here prestige, that is, reputation for power, is employed both as a deterrent to, and as preparation for, war. It is hoped that the prestige of one's own nation will be great enough to deter the other nations from going to war. At the same time, it is hoped that if this policy of prestige should fail, the mobilization of the armed forces, before the actual outbreak of war, will put one's own nation in the most advantageous military position possible under the circumstances. At that point, political and military policy tend to become two different aspects of the same thing. We shall have further occasion to point to the intimate relations between international politics and military policy in times of peace as well as in times of war.⁵

3. TWO OBJECTIVES OF THE POLICY OF PRESTIGE

The policy of prestige has two possible ultimate objectives: prestige for its own sake or, much more frequently, prestige in support of a policy of the status quo or of imperialism. While in national societies prestige is frequently

⁵ See below, Chapters VII, XXI, XXIX.

Politics among Nations

sought for its own sake, it is rarely the primary objective of international policies. In international politics prestige is at most the pleasant by-product of policies whose ultimate objectives are not the reputation for power but the substance of power. The individual members of a national society, protected as they are in their existence and social position by an integrated system of social institutions and rules of conduct, can afford to indulge in the competition for prestige as a kind of harmless social game. But nations, which as members of the international society must in the main rely upon their own power for the protection of their existence and power position, can hardly neglect the effect which gain or loss of prestige will have upon their power position on the international scene.

It is, therefore, not by accident that, as we have already pointed out, observers of international affairs who underrate the importance of power tend to take questions of prestige lightly. And it is likewise not by accident that it is not responsible statesmen, but only foolhardy egocentrics who are inclined to pursue a policy of prestige for its own sake. In modern times, William II and Mussolini are cases in point. Intoxicated with newly acquired domestic power, they regarded international politics as a kind of personal sport where in the exaltation of one's own nation and in the humiliation of others one enjoys one's own personal superiority. By doing so, however, they confused the international with the domestic scene. At home, the demonstration of their power, or at least of its appearance, would be at worst nothing more than harmless foolishness. Abroad, such a demonstration is playing with fire which will consume the player who does not have the power commensurate with his belief or his pretense. One-man governments, that is, absolute monarchies or dictatorships, tend to identify the personal glory of the ruler with the political interests of the nation. From the point of view of the successful conduct of foreign affairs this identification is a serious weakness, for it leads to a policy of prestige for its own sake instead of for the purpose of either maintaining the status quo or of imperialistic expansion.

The function which the policy of prestige fulfills for the policies of the status quo and of imperialism grows out of the very nature of international politics. The foreign policy of a nation is always the result of an estimate of the power relations as they exist between different nations at a certain moment of history and as they are likely to develop in the immediate and distant future. The foreign policy of the United States, for instance, is based upon an evaluation of the power of the United States in relation to, let us say, the power of Great Britain, the Soviet Union, and Argentina, and of the probable future development of the power of these different nations. Likewise, the foreign policies of Great Britain, the Soviet Union, and Argentina are based upon similar evaluations which are constantly subjected to review for the purpose of bringing them up to date.

It is the primary function of the policy of prestige to influence these evaluations. If, for instance, the United States can impress its power upon the Latin-American nations to such an extent as to convince them that its predominance in the Western Hemisphere is unchallengeable, its policy of the status quo in the Western Hemisphere is not likely to be challenged and its success will thus be assured. The relative political stability which Europe

Policy of Prestige

enjoyed during the twenties and in the beginning of the thirties was due mainly to the prestige of France as the strongest military power in the world. German imperialism owes its triumphs in the late thirties mainly to a successful policy of prestige. This policy was able to convince the nations, interested in the maintenance of the status quo, of Germany's superiority, if not invincibility. For instance, showing documentary films of the "blitzkrieg" in Poland and France to foreign audiences composed preferably of military and political leaders clearly served this purpose. Whatever the ultimate objectives of a nation's foreign policy, its prestige, that is, its reputation for power, is always an important and sometimes a decisive factor in determining success or failure of its foreign policy. A policy of prestige is, therefore, an indispensable element of a rational foreign policy.

A policy of prestige attains its very triumph when it gives the nation pursuing it such a reputation for power as to enable it to forego the actual employment of power altogether. Two factors make that triumph possible: reputation for unchallengeable power and reputation for self-restraint in using it. Of this rare combination the Roman and the British empires and the Good Neighbor Policy of the United States are the classic examples.

The longevity of the Roman Empire, in contrast to the fate of quick dissolution which generally befalls imperial structures of similar dimensions, was due primarily to the profound respect in which the name of a Roman was held within its confines. Rome was superior in political acumen and military strength to any one of the component parts of the Empire. By making the burden of its superiority as easy as possible to bear it deprived its subject peoples of the incentive to rid themselves of Roman domination. At worst one or the other of the subject peoples might revolt, but there was never incentive enough for the formation of a coalition sufficiently strong to challenge Rome. Isolated revolts would be dealt with swiftly and efficiently by preponderant Roman power, thus increasing Rome's prestige for power. The contrast between the dismal fate of those who dared to challenge Rome, and the peaceful and prosperous existence, under the protection of the Roman law, of those who remained loyal to Rome, increased Rome's reputation for moderation in the exercise of its power.

The same reputation for power tempered by self-restraint was one of the foundation stones of the British Empire. Observers have marveled at the ability of a few thousand British officials to dominate a few hundred million Indians, not to speak of the voluntary ties of loyalty which keep the self-governing dominions united in the Empire. But the ignominious defeats which Great Britain suffered in the Second World War at the hands of Japan shattered forever its reputation for unchallengeable power. And the cry for national liberation, raised by the subject races throughout Southeastern Asia, drowns out the memory of a tolerant rule mellowed by age and wisdom. With that twofold prestige gone and with the resources to maintain the Empire by sheer force unavailing, the Asiatic part of the British Empire did not for long survive the prestige of Britain.

Since the inauguration of the Good Neighbor Policy, the hegemony of the United States in the Western Hemisphere reposes likewise upon the reputation for unchallengeable power rather than upon its actual exercise.

Politics among Nations

The superiority of the United States in the Western Hemisphere is so obvious and overwhelming that prestige alone is sufficient to assure the United States the position among the American republics commensurate with its power. The United States can even at times afford to forego insistence upon the prestige which is its due, because the self-restraint thus manifested will make its hegemony more tolerable to its neighbors to the south. Thus the United States has made it a point, since the inauguration of the Good Neighbor Policy, to have Pan-American conferences meet in Latin-American countries rather than in the United States. Since in the Western Hemisphere the United States has the substance of unchallengeable power, it may well deem it the better part of wisdom not to insist upon all the manifestations of the prestige which goes with such overwhelming power, and to allow some other country in the Western Hemisphere to enjoy at least the appearances of power in the form of prestige.

4. TWO CORRUPTIONS OF THE POLICY OF PRESTIGE

For a nation to pursue a policy of prestige is, however, not enough. It can do too much or too little in this respect, and in either case it will run the risk of failure. It generally does too much when it paints an exaggerated picture of its power and thus attempts to gain a reputation for power which exceeds the power it actually possesses. In other words, it builds its prestige upon the appearances of power rather than upon its substance. Here the policy of prestige transforms itself into a policy of bluff. Its outstanding example in recent history is the policy of Italy from the Ethiopian War of 1935 to the African campaign of 1942. Embarking upon a policy of imperialistic expansion with the purpose of making the Mediterranean an Italian lake, Italy defied during the Ethiopian War and the Spanish Civil War what was then the foremost naval power on earth and the predominant power in the Mediterranean. It did so by creating the impression that it was a military power of the first order. Italy was successful in this policy so long as no other nation dared to put its pretense of power to the actual test. When this test came, it revealed the contrast between Italy's reputation for power, deliberately created by a number of propagandistic devices, and its actual power. It unmasked its policy of prestige as a policy of bluff.

The essence of a policy of bluff is well illustrated in the theater device of letting a score of extras, dressed as soldiers, walk about the stage, disappear behind the scenery, and come back again and again, thus creating the illusion of a great number of marching men. The ignorant and the gullible will easily be deceived by this appearance of armed might. The informed and detached observer will not fall victim to the deception. And if the stage directions require that the "army" give battle to another "army," the bluff becomes patent to anyone. Here the policy of bluff is reduced to its essentials, and its mechanics are demonstrated in elemental form. It is easy for the policy of bluff to succeed in the short run, but in the long run it can succeed only if it is able to postpone forever the test of actual performance, and this even the highest quality of statecraft cannot assure.

Policy of Prestige

The best that luck and political wisdom can do is to use the initial success of a policy of bluff for the purpose of bringing the actual power of one's nation up to its reputed quality. While the other nations are bluffed into giving that power undeserved consideration, time is gained for bringing prestige and actual power into harmony. A nation, therefore, which has fallen behind in the competition for power, especially in the field of armaments, might try to conceal its weakness behind a policy of bluff while at the same time endeavoring to overcome its handicap. When Great Britain, in the autumn and winter of 1940-41, was actually open to invasion, its prestige, far exceeding at that time its actual military strength, was probably the most important single factor deterring the Germans from the attempt to invade its territory. Subsequently, while maintaining the appearance of its defensive strength, it was able to acquire actual defensive strength. It must, however, be noted that luck came to the assistance of that policy of bluff in the form of Hitler's military mistakes and that this policy was not so much freely chosen by Great Britain as forced upon it as a desperate last resort by an almost irresistible necessity.⁶

While it thus remains true that it is generally a mistake in international politics to engage in a policy of bluff, it is no less a mistake to go to the other extreme and to be satisfied with a reputation for power which is inferior to the actual power possessed. The outstanding examples of this "negative policy of prestige" are the United States and the Soviet Union in the period between the two world wars and, more particularly, in the first years of the Second World War.

At the outbreak of the Second World War the United States was already potentially the most powerful nation on earth and it had openly declared its opposition to the imperialism of Germany and Japan. Nevertheless, Germany and Japan proceeded very much as though the United States as a first-rate power did not exist at all. The significance of the attack on Pearl Harbor from the point of view under discussion lies in the implied expression of contempt for the military strength of the United States. The reputation for power of the United States, that is, its prestige, was so low that Japan could base its war plans upon the assumption that American military strength would not recover from the blow of Pearl Harbor in time to influence the outcome of the war. American prestige was so low that Germany and Italy, instead of trying to keep the United States out of the European war, seemed almost eager to bring it in by declaring war against it on December 10, 1941. Hitler is quoted as having declared in 1934: "The American is no soldier. The inferiority and decadence of this allegedly New World is evident in its military inefficiency."⁷

⁶ One can safely say that in the two most critical periods of its history Great Britain owed its salvation, at least in part, to its prestige. When in 1797 all of Europe was at Napoleon's feet and France concentrated all its efforts upon the destruction of Great Britain, a mutiny broke out in the British fleet. For a time two loyal ships were all that stood between the continent and the British Isles. In the winter of 1940-41, Great Britain was, for however different reasons, similarly helpless. In both situations, the awe in which the British name was held was one of the factors deterring its enemies from an attack which the distribution of material power greatly favored.

⁷ Hermann Rauschning, *The Voice of Destruction* (New York: G. P. Putnam's Sons, 1940), p. 71.

Politics among Nations

So enormous a depreciation was primarily due to what can almost be called the absence of an American policy of prestige in so far as reputation for military power is concerned. Far from demonstrating to the other nations what the human and material potentialities of the United States could mean in terms of military power, the United States seemed almost anxious to prove to the world its unwillingness, if not inability, to transform those enormous potentialities into actual instruments of war. Thus the United States invited neglect and attack from its enemies, failure for its policies, mortal danger to its vital interests.

The Soviet Union had to cope with similar results not because it neglected but because it failed in, its policy of prestige. Throughout the period between the two world wars, the reputation of the Soviet Union for power was low. While Germany, France, and Great Britain at times tried to secure Russian support for their foreign policies, no nation had a sufficiently high opinion of the power of the Soviet Union to overcome the aversion to Russian political ideology and the fear of its spreading through the rest of Europe. When, for instance, during the Czechoslovakian crisis of 1938, France and Great Britain were confronted with the alternative of either approving the imperialistic expansion of Germany or trying to check it with the aid of the Soviet Union, the latter's prestige was so low that the Western European powers rejected its proffered co-operation without much hesitation. The military prestige of the Soviet Union reached its lowest point during the campaign against Finland in 1939-40 when little Finland seemed able to hold its own against the Russian giant. That lack of prestige was one of the factors which convinced the German general staff as well as the general staffs of the allied nations that the Soviet Union would be unable to withstand a German attack.

While Russian prestige soared high from the battle of Stalingrad to the end of the Second World War, the postwar years have seen it on the downgrade again. However, for a wise foreign policy, this ought not to be a matter of indifference. For if the Soviet Union had appeared to be as powerful in 1938 or 1939 or 1941 as it actually was, that is, if its prestige had then been commensurate with its power, the policies of the other nations with respect to the Soviet Union might easily have been different, and the destiny of the Soviet Union and of the world might have been different as well. Whether today the Soviet Union is as strong as it seems to be, or stronger, or weaker, is a question of fundamental importance for both the Soviet Union and the rest of the world. The same is true of the United States and of any other nation playing an active role in international politics. To demonstrate to the rest of the world the power one's own nation possesses, revealing neither too much nor too little, is the task of a wisely conceived policy of prestige.

CHAPTER V

The Ideological Element in International Policies

I. THE NATURE OF POLITICAL IDEOLOGIES ¹

It is a characteristic aspect of all politics, domestic as well as international, that frequently its basic manifestations do not appear as what they actually are — that is, manifestations of a struggle for power. Rather, the element of power as the immediate goal of the policy pursued is explained and justified in ethical, legal, or biological terms. Statesmen generally refer to their policies not in terms of power but in terms of either ethical and legal principles or biological necessities. In other words, while all politics is necessarily pursuit of power, ideologies render involvement in that contest for power psychologically and morally acceptable to the actors and their audience.

These legal and ethical principles and biological necessities fulfill a dual function in the sphere of international politics. They are either the ultimate goals of political action, of which we have spoken before,² that is, those ultimate objectives for the realization of which political power is sought, or they are the pretexts and false fronts behind which the element of power, inherent in all politics, is concealed. These principles and necessities may fulfill one or the other function, or they may fulfill them both at the same time. A legal and ethical principle such as justice, for example, or a biological necessity, such as an adequate standard of living, may be the goal of a foreign policy, or it may be an ideology, or it may be both at the same time. Since we are not concerned here with the ultimate goals of international politics, we shall

¹ The concept of ideology used in this chapter corresponds to what Karl Mannheim has called "particular ideology." Cf. Karl Mannheim, *Ideology and Utopia* (New York: Harcourt, Brace and Company, 1936), p. 49: "The particular conception of ideology is implied when the term denotes that we are sceptical of the ideas and representations advanced by our opponent. They are regarded as more or less conscious disguises of the real nature of a situation, the true recognition of which would not be in accord with his interests. These distortions range all the way from conscious lies to half-conscious and unwitting disguises; from calculated attempts to dupe others to self-deception." See also p. 238: "The study of ideologies has made it its task to unmask the more or less conscious deceptions and disguises of human interest groups, particularly those of political parties."

² See above, pp. 13 ff.

Politics among Nations

deal with ethical and legal principles and biological necessities only in so far as they perform the function of ideologies.

These ideologies are not the accidental outgrowth of the hypocrisy of certain individuals who need only to be replaced by other, more honest, individuals in order to make the conduct of foreign affairs more decent. Disappointment always follows such expectations. The members of the opposition who were most vocal in exposing the deviousness of Franklin D. Roosevelt's or Churchill's foreign policies shocked their followers, once they had become responsible for the conduct of foreign affairs, by their own use of ideological disguises. It is the very nature of politics to compel the actor on the political scene to use ideologies in order to disguise the immediate goal of his action. The immediate goal of political action is power, and political power is power over the minds and actions of men. Yet those who have been chosen as the prospective object of the power of others are themselves intent upon gaining power over others. Thus the actor on the political scene is always at the same time a prospective master of others and a prospective subject of others. While he seeks power over others, his own freedom is threatened by a similar desire on the part of others.

To this ambivalence of man as a political being corresponds the ambivalence of his moral evaluation of this condition. He will consider his own desire for power as just and will condemn as unjust the desire of others to gain power over him. In the years after the Second World War, the Russians have found their own designs for power justified by considerations of their own security. But they have condemned as "imperialistic" and preparatory to world conquest the expansion of American power. The United States has put a similar stigma on Russian aspirations, while it views its own international objectives as necessities of national defense.

The ambivalence of this evaluation, characteristic of the approach of all nations to the problem of power, is again inherent in the very nature of international politics. The nation which would dispense with ideologies and frankly state that it wants power and will, therefore, oppose similar aspirations of other nations, would at once find itself at a great, perhaps decisive, disadvantage in the struggle for power. That frank admission would, on the one hand, unite the other nations in fierce resistance to a foreign policy so unequivocally stated and would thereby compel the nation pursuing it to employ more power than would otherwise be necessary. On the other hand, that admission is tantamount to flouting openly the universally accepted moral standards of the international community and would thereby put the particular nation in a position where it would be likely to pursue its foreign policy half-heartedly and with a bad conscience. To rally a people behind the government's foreign policy and to marshal all the national energies and resources to its support, the spokesman of the nation must appeal to biological necessities, such as national existence, and to moral principles, such as justice, rather than to power. In no other way can a nation attain the enthusiasm and willingness to sacrifice without which no foreign policy can pass the ultimate test of strength.

Such are the psychological forces which inevitably engender the ideologies of international policies and make them weapons in the struggle for power

The Ideological Element in International Policies

on the international scene. A government whose foreign policy appeals to the intellectual convictions and moral valuations of its own people has gained an incalculable advantage over an opponent who has not succeeded in choosing goals which have such appeal or in making the chosen goals appear to have it. Ideologies, no less than ideas, are weapons which raise the national morale and, with it, the power of one nation and, in the very act of doing so, may lower the morale of the opponent. The enormous contribution which Woodrow Wilson's Fourteen Points made to the victory of the Allies in the First World War by strengthening the morale of the Allies and weakening the morale of the Central Powers is the classic example of the importance of the moral factor for international politics.⁸

2. TYPICAL IDEOLOGIES OF INTERNATIONAL POLICIES

It follows from the character of these forces that imperialistic policies resort practically always to ideological disguises, whereas status quo policies more frequently can be presented as what they actually are. It also follows from the character of these forces that certain types of ideologies are coordinated with certain types of international policies.

a) Ideologies of the Status Quo

A policy of the status quo can often afford to reveal its true nature and to dispense with ideological disguises, because the status quo has already, by virtue of its very existence, acquired a certain moral legitimacy. What exists must have something to be said in its favor; otherwise it would not exist. Since a nation which pursues a policy of the status quo seeks the preservation of the power it already has, it may avoid the need to allay the resentment of other nations and its own scruples. This is especially so when the preservation of the territorial status quo is not open to moral or legal attack and when national power has by tradition been exclusively used for the preservation of this status quo. Such nations as Switzerland, Denmark, Norway, and Sweden do not need to hesitate to define their foreign policies in terms of the maintenance of the status quo, since this status quo is generally recognized as legitimate. Other nations, such as Great Britain, France, Yugoslavia, Czechoslovakia, Rumania, which in the period between the two world wars in the main pursued a policy of the status quo, could not afford simply to declare that their foreign policies aimed at the defense of their possessions. Since the legitimacy of the status quo of 1919 was itself being challenged within and without these nations, they had to invoke ideal principles able to meet that challenge. The ideals of permanent peace and of international law fulfilled that purpose.

The ideals of permanent peace and of international law are eminently

⁸ On the problem of national morale in general, see below, pp. 100 ff.

Politics among Nations

qualified to serve as ideologies for a policy of the status quo. Since imperialistic policies, by disturbing the status quo, frequently lead to war and must always take the possibility of war into account, a foreign policy which proclaims pacifism as its guiding principle is by the same token anti-imperialistic and supports the maintenance of the status quo. By expressing in pacifist terms the objectives of the policy of the status quo, a statesman puts the stigma of warmongering upon his imperialistic opponents, clears his and his countrymen's conscience of moral scruples, and can hope to win the support of all countries interested in the maintenance of the status quo.

The ideal of international law fulfills a similar ideological function for policies of the status quo. Law in general and, especially, international law is primarily a static social force. It defines a certain distribution of power and offers standards and processes to ascertain and maintain it in concrete situations. Domestic law, through a developed system of legislation, judicial decisions, and law enforcement, allows for adaptations and sometimes even considerable changes within the general distribution of power. International law, in the absence of such a system making for lawful change, is, as will be shown later,⁴ not only primarily, but essentially, a static force. The invocation of international law, of "order under law," of "ordinary legal processes" in support of a particular foreign policy, therefore, always indicates the ideological disguise of a policy of the status quo. More particularly, when an international organization, such as the League of Nations, has been established for the purpose of maintaining a particular status quo, support of that organization becomes tantamount to support of that particular status quo.

Since the end of the First World War, it has become rather common to make use of such legalistic ideologies in justification of a policy of the status quo. While the alliances of former periods of history have not disappeared, they tend to become "regional arrangements" within an over-all legal organization. The "maintenance of the status quo" yields to the "maintenance of international peace and security." A number of states which have the same interest in the maintenance of the status quo will be likely to protect their common interests against a threat from a particular source not by a "Holy Alliance," but by a "system of collective security" or a "treaty of mutual assistance." Since, frequently, changes in the status quo are brought about at the expense of small nations, defense of the rights of small nations, such as Belgium in 1914, Finland and Poland in 1939, becomes under appropriate conditions another ideology of the policy of the status quo.

b) Ideologies of Imperialism

A policy of imperialism is always in need of an ideology; for, in contrast to a policy of the status quo, imperialism has always the burden of proof. It must prove that the status quo which it seeks to overthrow deserves to be overthrown and that the moral legitimacy which in the minds of many attaches to things as they are ought to yield to a higher principle of morality calling for a new distribution of power. Thus, in the words of Gibbon: "For

⁴ See below, Chapter XXIV.

The Ideological Element in International Policies

every war a motive of safety or revenge, of honor or zeal, of right or convenience, may be readily found in the jurisprudence of conquerors.”⁵

In so far as the typical ideologies of imperialism make use of legal concepts, they cannot well refer to positive international law, that is, to international law as it actually is. As we have seen, the static character of international law makes it the natural ideological ally of the status quo. The dynamic quality of imperialism requires dynamic ideologies. In the domain of law it is the doctrine of natural law, that is, of the law as it ought to be, which fits the ideological needs of imperialism. Against the injustices of international law as it exists, symbolizing the status quo, the imperialistic nation will invoke a higher law which corresponds to the requirements of justice. Thus Nazi Germany based its demands for the revision of the status quo of Versailles primarily upon the principle of equality which the Treaty of Versailles had violated. The demand for colonies, for instance, of which the Treaty of Versailles had deprived Germany completely, and the demand for the revision of the unilateral disarmament provisions of the same treaty were derived from the same principle.

When the imperialistic policy is not directed against a particular status quo resulting from a lost war, but grows from a power vacuum inviting conquest, moral ideologies which make it an unavoidable duty to conquer take the place of the appeal to a just natural law against an unjust positive law. Then to conquer weak peoples appears as “the white man’s burden,” the “national mission,” “manifest destiny,” a “sacred trust,” a “Christian duty.” Colonial imperialism, in particular, has frequently been disguised by ideological slogans of this kind, such as the “blessings of Western civilization” which it was the mission of the conqueror to bring to the colored races of the earth. The Japanese ideology of the East Asiatic “co-prosperity zone” carries a similar connotation of a humanitarian mission. Whenever a political philosophy, held with the fervor of religious faiths, coincides with an imperialistic policy, it becomes a ready instrument of ideological disguise. Arab imperialism during the period of Arab expansion justified itself as the fulfillment of religious duty. Napoleonic imperialism swept over Europe under the banner of “Liberty, Equality, Fraternity.” Russian imperialism, especially in its aspirations for Constantinople and the Dardanelles, has successively or simultaneously made use of the Orthodox faith, Pan-Slavism, world revolution, and defenses from capitalist encirclement.

In modern times, especially under the influence of the social philosophies of Darwin and Spencer, the ideologies of imperialism have preferred biological arguments. Transferred to international politics, the philosophy of the survival of the fittest sees in the military superiority of a strong nation over a weak one a natural phenomenon which makes the latter the preordained object of the former’s power. According to this philosophy, it would be against nature if the strong did not dominate the weak and if the weak tried to be the equal of the strong. The strong nation has a right to a “place in the sun,” it is the “salt of the earth.” As a famous German sociologist discovered in the First World War, the Germanic “hero” must necessarily win out over

⁵ *The Decline and Fall of the Roman Empire* (The Modern Library Edition), II, 1235.

Politics among Nations

the British "shopkeeper." That the inferior races should serve the master race is a law of nature that only villains and fools will oppose; slavery and extermination are the latter's just desert.

Communism, fascism, and nazism as well as Japanese imperialism have given these biological ideologies a revolutionary turn. The nations which nature has appointed to be the masters of the earth are kept in inferiority by the trickery and violence of the other nations. The vigorous but poor "have-nots" are cut off from the riches of the earth by the wealthy but decadent "haves." The proletarian nations, inspired by ideals, must fight the capitalist nations defending their money-bags. The ideology of overpopulation has found particular favor with Germany, Italy, and Japan. The Germans are a "people without space" who, if they cannot obtain "living space," must "suffocate" and, if they cannot obtain sources of raw materials, must "starve." With different variations, this ideology was used in the thirties also by Italy and Japan to justify their expansionist policies and to disguise their imperialistic goals.⁶

The most widely practiced disguise and justification of imperialism has, however, always been the ideology of anti-imperialism.⁷ It is so widely used because it is the most effective of all ideologies of imperialism. As, according to Huey Long, fascism will come to the United States in the guise of anti-fascism, so imperialism has come to many a country in the guise of anti-imperialism. In 1914 as well as in 1939, both sides went to war in order to defend themselves against the imperialism of the other side. Germany attacked the Soviet Union in 1941 in order to forestall the latter's imperialistic designs. Since the end of the Second World War, American and British as well as Russian foreign policy has been justified by the imperialistic objectives of other nations. By thus presenting one's own foreign policy, regardless of its actual character, as anti-imperialistic, that is, defensive and protective of the status quo, one gives one's own people that good conscience and confidence in the justice of their own cause without which no people can support its

⁶ The purely ideological character of the claim for colonies, justified in the period between the two world wars by Germany, Italy, and Japan with population pressure and economic distress, is clearly demonstrated by the relevant population and economic statistics. The four African colonies of Germany which covered 930,000 square miles had, in 1914, a population of almost twelve million of which only 20,000 were white. It was pointed out at that time that more Germans were living in the city of Paris than in all of Germany's colonies combined. After Eritrea had been an Italian colony for fifty years, the 2,000 square miles of territory most suitable for settlement contained about 400 Italian inhabitants. The Japanese colonies of Korea and Formosa absorbed within a period of forty years less than one year's increase of the Japanese population.

As for the economic importance of colonies to their mother countries, the figures are eloquent in the case of Germany and Italy. The imports from, and the exports to, the German colonies amounted in 1913 to 0.5 per cent of the total German imports and exports. In 1933, the imports from the Italian colonies were 1.6 per cent of the total imports, and the exports to them were 7.2 per cent of all the exports from Italy; a considerable portion of the latter must have consisted of war material. Only for Japan were its colonies of paramount economic importance, its trade with them in 1934 amounting to almost 35 per cent of its total trade (23.1 per cent of the total imports, 22 per cent of the total exports). See Royal Institute of International Affairs, *The Colonial Problem* (London, New York, Toronto: Oxford University Press, 1937), especially p. 287.

⁷ A variant of the ideology of anti-imperialism is the ideology of anti-power politics. According to this ideology, other nations are motivated in their policies by aspirations for power, while one's own nation, free from such base motives, pursues purely ideal objectives.

The Ideological Element in International Policies

foreign policy wholeheartedly and fight successfully for it. At the same time one may confound the enemy who, ideologically less well prepared, may no longer be certain on which side justice is to be found.

c) Ambiguous Ideologies

The ideology of anti-imperialism draws its effectiveness from its ambiguity. It confounds the observer who cannot always be sure whether he is dealing with an ideology of imperialism or with the true expression of a policy of the status quo. This confounding effect is present whenever an ideology is not made to order, as it were, for a particular type of policy, but can be worn by the defenders of the status quo as well as by the promoters of imperialism. The ideologies of national self-determination and of the United Nations are of this character.

The principle of national self-determination as conceived by Woodrow Wilson justified the liberation of the Central and Eastern European nationalities from foreign domination. Theoretically it was opposed not only to the status quo of empire, but also to imperialism of any kind, either on the part of the old imperial powers — Germany, Austria, and Russia — or on the part of the liberated small nations. Yet the destruction of the old imperial order at once called forth, still in the name of self-determination, new imperialisms. Those of Poland, Czechoslovakia, Rumania, and Yugoslavia are as outstanding as they were inevitable; for the power vacuum left by the breakdown of the old imperial order had to be filled and the newly liberated nations were there to fill it. As soon as they had installed themselves in power, they invoked the selfsame principle of national self-determination in defense of the new status quo. This principle was their most potent ideological weapon from the end of the First to the end of the Second World War.

It was by a stroke of propagandistic genius that Hitler hit upon the principle of national self-determination in order to disguise and justify his policies of territorial expansion. The German minorities of Czechoslovakia and Poland, under the banner of national self-determination, were now to play the same role in undermining the national existence of Czechoslovakia and Poland which the Czech, Slovak, and Polish nationalities, under the same ideological banner, had played in undermining the national existence of the Austrian-Hungarian Empire. With their own ideological weapon turned against them, the benefactors of the status quo of Versailles had no ideology, except the one of law and order, with which to defend that status quo. Thus Austria and Czechoslovakia were surrendered, and Poland was exposed to mortal danger. After the settlement of Munich granted the German demands with regard to Czechoslovakia, the *London Times*, making the German ideology its own, declared: "Self-determination, the professed principle of the Treaty of Versailles, has been invoked by Herr Hitler against its written text, and his appeal has been allowed."⁸ Rarely, if ever, has modern history offered a more striking example of the importance of ideologies in international politics and of the confounding and disarming effect of an ambiguous ideology aptly employed.

⁸ *London Times*, September 28, 1938.

Politics among Nations

The United Nations was intended at its inception to serve as an instrument of China, France, Great Britain, the Soviet Union, and the United States, and of their allies, for maintaining the status quo as established by the victory of these nations in the Second World War. However, in the years immediately following the conclusion of the Second World War this status quo has proved to be only provisional and subject to contradictory interpretations and claims by the different nations. The ideology of the United Nations is, therefore, used by these different nations for the purpose of disguising and justifying their particular interpretations and claims. All nations appear as the champions of the United Nations and quote its charter in support of the particular policies they are pursuing. These policies being antagonistic, the reference to the United Nations and its charter becomes an ideological device justifying one's own policy in the light of generally accepted principles and at the same time concealing its true character. Its ambiguity makes this ideology a weapon with which to confound one's enemies and strengthen one's friends.

3. THE PROBLEM OF RECOGNITION

To see through these ideological disguises and to grasp behind them the actual political forces and phenomena becomes, then, one of the most important and most difficult tasks of the student of international politics. It is important because, unless it is done, the correct determination of the character of the foreign policy with which one happens to deal becomes impossible. The recognition of imperialistic tendencies and of their particular character depends upon a clear distinction between the ideological pretense which generally disavows imperialistic aspirations altogether and the actual objectives of the policies pursued. To make this distinction correctly is difficult because of the general difficulty of detecting the true meaning of any human action apart from what the actor believes or feigns it to mean. This general problem is aggravated by two other difficulties peculiar, at least in their generality, to international politics. One is to distinguish a boast or bluff indicative of a policy of prestige from an ideological disguise of actual imperialism. The other is to discover behind an ideology of the status quo or of localized imperialism the true meaning of the policy actually pursued.

We have already had occasion to refer to the foreign policy of William II which conveyed through its language and manifestations the impression of being outright imperialistic while it was actually a strange mixture of imperialistic designs and neurotic boastfulness. Conversely, the true imperialistic essence of the foreign policies of Hitler and Mussolini was not generally recognized up to the late thirties. It was explained away as mere bluff and boastfulness for home consumption. To determine the true character of a foreign policy behind its deliberate or unconscious ideological disguise becomes, however, particularly difficult when the ideologies of the status quo are used as a disguise. Of this difficulty the period following the Second World War offers striking examples in the foreign policies of the United States and the Soviet Union.

The Ideological Element in International Policies

Both nations have expressed the objectives of their foreign policies in the almost identical terms of status quo ideologies. The sources of these common ideologies are the declarations of Teheran, Yalta, and Potsdam, signed by the representatives of both countries and accepted by both as the guiding principles of their foreign policies. Both the Soviet Union and the United States have proclaimed that they have no territorial ambitions beyond the enemy territories they hold; that they want to see free and democratic governments established everywhere; that they are guided by considerations of security and national defense; and that it is the capitalist or communist imperialism of the other side against which they are compelled, in spite of their own wishes, to defend themselves.

Most Americans and most Russians are obviously convinced that these statements are a faithful expression of the true character of their countries' foreign policy. Yet they cannot both be right, while one or the other or both may be wrong. For it may be that the Soviet Union misunderstands the foreign policy of the United States, or that the United States misunderstands the foreign policy of the Soviet Union, or that both misunderstand each other. The solution of this riddle upon which the fate of the world may well depend is not to be sought in the character of the ideologies alone, but in the sum total of the factors determining the foreign policy of a nation. Of this more will be said later.⁹

⁹ See below, Part Ten.

PART THREE

NATIONAL POWER

CHAPTER VI

The Essence of National Power

I. WHAT IS NATIONAL POWER?

We have said that by power we mean the power of man over the minds and actions of other men a phenomenon to be found whenever human beings live in social contact with each other. We have spoken of the "power of a nation" or of "national power" as though the concept were self-evident and sufficiently explained by what we have said about power in general. Yet, while it can be easily understood that individuals seek power, how are we to explain the aspirations for power in the collectivities called nations? What is a nation? What do we mean when we attribute to a nation aspirations and actions?

A nation as such is obviously not an empirical thing. A nation as such cannot be seen. What can be empirically observed are only the individuals who belong to a nation. Hence, a nation is an abstraction from a number of individuals who have certain characteristics in common, and it is these characteristics which make them members of the same nation. Besides being a member of a nation and thinking, feeling, and acting in that capacity, the individual may belong to a church, a social or economic class, a political party, a family, and may think, feel, and act in these capacities. Apart from being a member of all these social groups, he is also a human being as such, and thinks, feels, and acts in that capacity. Therefore, when we speak of the power or of the foreign policy of a certain nation, we can only mean in empirical terms the power or the foreign policy of certain individuals who belong to the same nation.

Yet this poses another difficulty. The power or the foreign policy of the United States is obviously not the power or the foreign policy of all the individuals who belong to the nation called the United States of America. The fact that the United States emerged from the Second World War as the most powerful nation on earth has not affected the power of the great mass of individual Americans. It has, however, affected the power of all those individuals who administer the foreign affairs of the United States and, more particularly, speak for and represent the United States on the international

Politics among Nations

scene. (For a nation pursues international policies as a legal organization called a state whose agents act as the representatives of the nation on the international scene. They speak for it, negotiate treaties in its name, define its objectives, choose the means for achieving them, and try to maintain, increase, and demonstrate its power. They are the individuals who, when they appear as representatives of their nation on the international scene, wield the power and pursue the policies of their nation. It is to them that we refer when we speak in empirical terms of the power and of the foreign policy of a nation.)

How, then, does it come about that the great mass of the individual members of a nation, whose individual power is not affected by the vicissitudes of national power, identify themselves with the power and the foreign policies of their nation, experience this power and these policies as their own, and do so with an emotional intensity often surpassing the emotional attachment to their individual aspirations for power? By asking this question, we are posing the problem of modern nationalism. In preceding periods of history the collectivity with whose power and aspirations for power the individual identified himself was determined by ties of blood, of religion, or of common loyalty to a feudal lord or prince. In our time the identification with the power and policies of the nation has largely superseded or, in any case, overshadows those older identifications. How is this phenomenon of modern nationalism to be explained?

We have learned from our discussion of the ideologies of international policies that in the mind of the individual the aspirations for power of others bear the stigma of immorality. While this moral depreciation has one of its roots in the desire of the prospective victim of the power of others to defend his freedom against this threat, the other root stems from the attempt of society as a whole to suppress and keep in bounds individual aspirations for power. Society has established a network of rules of conduct and institutional devices for controlling individual power drives. These rules and devices either divert individual power drives into channels where they cannot endanger society, or else they weaken them or suppress them altogether. Law, ethics, and mores, innumerable social institutions and arrangements, such as competitive examinations, election contests, sports, social clubs, and fraternal organizations—all serve that purpose.

In consequence, most people are unable to satisfy their desire for power within the national community. Within that community, only a relatively small group permanently wields power over great numbers of people without being subject to extensive limitations by others. The great mass of the population is to a much greater extent the object of power than its wielder. Not being able to find full satisfaction of their desire for power within the national boundaries, the people project those unsatisfied aspirations onto the international scene. There they find vicarious satisfaction in identification with the power drives of the nation. When the citizen of the United States thinks of the power of his country, he experiences the same kind of exhilaration the citizen of Rome must have felt when, identifying himself with Rome and its power and by the same token contrasting himself with the stranger, he would say; "*Civis Romanus sum.*" When we are conscious of being mem-

The Essence of National Power

bers of the most powerful nation on earth, the nation with the greatest industrial capacity and the monopoly of the atomic bomb, we flatter ourselves and feel a great pride. It is as though we all, not as individuals but collectively, as members of the same nation, owned and controlled so magnificent a power. (The power which our representatives wield on the international scene becomes our own, and the frustrations which we experience within the national community are compensated for by the vicarious enjoyment of the power of the nation.)

These psychological trends, operating within the individual members of a nation, find support in the rules of conduct and in the institutions of society itself. Society restrains aspirations for individual power within the national community and puts the mark of opprobrium upon certain power drives pointing toward individual aggrandizement. But it encourages and glorifies the tendencies of the great mass of the population, frustrated in its individual power drives, to identify itself with the nation's struggle for power on the international scene. (Power pursued by the individual for his own sake is considered an evil to be tolerated only within certain bounds and in certain manifestations. Power disguised by ideologies and pursued in the name and for the sake of the nation becomes a good for which all citizens must strive.) The national symbols, especially in so far as they have reference to the armed forces and the relations with other nations, are instruments of that identification of the individual with the power of the nation. The ethics and mores of society tend to make that identification attractive by holding out rewards and threatening punishments.

(Thus it is not by accident that certain groups of the population are either the most militant supporters of the national aspirations for power in the international field, or else refuse to have anything to do with them at all.) These are the groups which are primarily the object of the power of others and are most thoroughly deprived of outlets for their own power drives or are most insecure in the possession of whatever power they may have within the national community. (The lower middle classes especially, such as the white collar workers, but also the main bulk of the laboring masses,¹ identify themselves completely with the national aspirations for power. Or else, and here the main example is the revolutionary proletariat, particularly in Europe, they do not identify themselves with national aspirations at all. While the latter group has thus far been of small concern for the international policies of the United States, the former has taken on ever greater importance.)

It is here, then, that one must seek the roots of modern nationalism and the explanation for the ever increasing ferocity with which international politics is pursued in modern times. The increasing insecurity of the individual in Western societies, especially in the lower strata, has magnified enormously the frustration of individual power drives. This, in turn, has given rise to an increased desire for compensatory identification with the collective national aspirations for power. These increases have been quantitative as well as qualitative.

¹ They have, in terms of power, less to lose and more to gain from nationalistic foreign policies than any other group of the population, with the exception of the military.

2. ROOTS OF MODERN NATIONALISM

Until the time of the Napoleonic Wars, only very small groups of the population identified themselves with the foreign policies of their nation. Foreign policies were truly not national but dynastic policies, and the identification was with the power and the policies of the individual monarch rather than with the power and the policies of a collectivity, such as the nation. As Goethe put it in a significant passage of his autobiography: "We all felt for Frederick [the Great], but what did we care for Prussia?"

With the Napoleonic Wars began the period of national foreign policies and wars, that is, the identification of the great masses of the citizens of a nation with national power and national policies. Up to the First World War it was doubtful to what degree the members of the European socialist parties identified themselves with the power and policies of their respective nations. Yet the full participation in that war of the main bulk of the workers in all belligerent countries demonstrated the identification of practically the whole population with the power and policies of their respective nations.

The Second World War has, however, brought about a certain retrogression from that maximum of identification which the First World War witnessed. That retrogression took place on the top and at the base of the social pyramid. On the one hand, relatively small, yet powerful, groups of intellectual, political, and military leaders in Great Britain and France either refused to identify themselves with their countries or even preferred to identify themselves with the national enemy. The leaders who felt this way were insecure in their power positions, especially in view of the initial political and military weakness of their countries, and the enemy alone seemed to be able to assure them their positions on top of the social pyramid. On the other hand, the French Communists, owing allegiance to both France and the Soviet Union, were able to identify themselves fully with their nation only after the German attack on the Soviet Union in 1941 had brought both allegiances into play. The German attack on France alone was unable to rouse them to active opposition to the invader. But the German attack on the Soviet Union made France and the Soviet Union allies in a common cause and allowed the French Communists to oppose in the German invaders of France the common enemy of France and the Soviet Union alike. The identification of the French Communists with French national policies was predicated upon the identity of those policies with Russian interests and policies. This Communist allegiance to foreign interests and policies, which take precedence over the national ones, is a universal phenomenon which, as such, is a challenge to the cohesion of the national state and to its very existence.²

Qualitatively, the emotional intensity of the identification of the individual with his nation stands in inverse proportion to the stability of the particular society as reflected in the sense of security of its members. The greater the stability of society and the sense of security of its members, the smaller are the chances for collective emotions to seek an outlet in aggres-

² See also below, Chapter XIV.

The Essence of National Power

sive nationalism, and vice versa.⁸ The revolutionary wars of France in the last decade of the eighteenth century and the wars of liberation against Napoleon from 1812-15 are the first examples in modern times of mass insecurity, induced by the instability of domestic societies and leading to emotional outbursts in the form of fervent mass identifications with aggressive foreign policies and wars. Social instability became acute in Western civilization during the nineteenth century. It became permanent in the twentieth century as a result of the weakening of the ties of tradition, especially in the form of religion, and as a result of increased rationalization of life and work, and of cyclical economic crises. The insecurity of the groups affected by these factors found an emotional outlet in fixed and emotionally accentuated nationalistic identifications. As Western society became ever more unstable, the sense of insecurity deepened and the emotional attachment to the nation as the symbolic substitute for the individual became ever stronger. With the world wars, revolutions, concentration of economic, political, and military power, and economic crises of the twentieth century it reached the fervor of a secular religion. Contests for power now took on the ideological aspects of struggles between good and evil. Foreign policies transformed themselves into sacred missions. Wars were fought as crusades, for the purpose of bringing the true political religion to the rest of the world.

This relation between social disintegration, personal insecurity, and the ferocity of modern nationalistic power drives can be studied to particular advantage in German fascism, where these three elements were more highly developed than anywhere else. The general tendencies of the modern age toward social disintegration were in Germany driven to extremes by a conjunction of certain elements in the national character favoring the extremes rather than mediating and compromising positions, and by three events which weakened the social fabric of Germany to such an extent as to make it an easy prey for the consuming fire of national socialism.

The first of these events was the defeat in the First World War, coincident with a revolution which was held responsible not only for the destruction of traditional political values and institutions, but for the loss of the war itself. The revolution naturally brought loss of power and insecurity in social status to those who had been at or near the top of the social hierarchy under the monarchy. Yet the social situation of large masses of the population was similarly affected by the impact of the idea that defeat and revolution were both the result of treacherous machinations of domestic and foreign enemies working for the destruction of Germany. Thus Germany was not only surrounded and "encircled" by foreign enemies, but its own body politic was shot through with invisible bacilli and parasites, sapping its strength and bent upon destroying it.

The second event was the inflation of the early twenties which proletarianized economically large sectors of the middle classes and weakened, if not destroyed, in the people at large the traditional moral principles of honesty and fair dealing. The middle classes, in protest against their economic proletarianization, embraced the most anti-proletarian and nationalistic ideologies

⁸ These collective emotions may, of course, seek an outlet in aggressiveness within the nation as well, that is, in the form of class struggle, revolution, and civil war.

Politics among Nations

available. The lower strata of the middle classes especially had always derived at least a limited satisfaction from their superiority to the proletariat. If they viewed the social pyramid as a whole, they had always to look up much farther than they were able to look down. Yet, while they were not actually at the bottom of the social pyramid, they were uncomfortably close to it. Hence their frustrations and insecurity and their predisposition for the nationalistic identification. Now inflation pushed them down to the bottom, and in the desperate struggle to escape social and political identification with the amorphous mass of the proletariat they found succor in the theory and practice of national socialism. For national socialism offered them lower races to look down upon and foreign enemies to feel superior to and conquer.

Finally, the economic crisis of 1929 brought all the different groups of the German people in different ways face to face with the actual or threatened loss of social status and intellectual, moral, and economic insecurity. The workers were faced with actual or threatened permanent unemployment. Those groups of the middle classes who had recovered from the economic devastation of inflation were losing what they had regained. The industrialists had to cope with increased social obligations and were haunted by the fear of revolution. National socialism focused all those fears, insecurities, and frustrations upon two foreign enemies: the Treaty of Versailles and bolshevism, and their alleged domestic supporters. It channeled all those unsatisfied emotions into one mighty stream of nationalistic fanaticism. Thus national socialism was able to identify in a truly totalitarian fashion the aspirations of the individual German with the power objectives of the German nation. Nowhere in modern history has that identification been more complete. Nowhere has that sphere in which the individual pursues his aspirations for power for their own sake been smaller. Nor has the force of the emotional impetus with which that identification transformed itself into aggressiveness on the international scene been equaled in modern civilization.

While the transformation of individual frustrations into collective identification with the nation has nowhere in modern history been more comprehensive and intensive than in National Socialist Germany, nevertheless the German variety of modern nationalism differs in degree rather than in kind from the nationalism of other great powers, such as the nationalism of the Soviet Union or of the United States. In the Soviet Union the great mass of the population has no opportunity to satisfy its power drives within the domestic society. The average Russian worker and peasant has nobody to look down upon, and his insecurity is intensified by the practices of the police state as well as by a standard of living so low as to threaten at times his physical survival. Here, too, a totalitarian regime projects these frustrations, insecurities, and fears onto the international scene where the individual Russian finds in the identification with "the most progressive country in the world," "the fatherland of socialism," vicarious satisfaction for his aspirations for power. The conviction, seemingly supported by historic experience, that the nation with which he identifies himself is constantly menaced by capitalist enemies serves to elevate his personal fears and insecurities onto the collective plane. His personal fears are thus transformed into anxiety for the nation. Identification with the nation thus serves the dual function of satisfying individual

The Essence of National Power

power drives and alleviating individual fears by projecting both onto the international scene.

In the United States, the process by which national power is appropriated by the individual and experienced as his own resembles by and large the typical pattern as it developed in Western civilization during the nineteenth century. That is to say, the identification of the individual with the power and the international policies of the nation proceeds largely in terms of the typical frustrations and insecurities of the middle class. Yet American society is to a much greater extent a middle-class society than any other society in Western civilization. More importantly, whatever class distinctions there may be tend to be mitigated, if not resolved, in American society by the common denominator of middle-class values and aspirations. The identification of the individual with the nation in terms of middle-class frustrations and aspirations is, therefore, almost as predominant and typical in American society as the proletarian identification is in the Soviet Union. On the other hand, the relatively great mobility of American society opens to the great masses of the population avenues for social and economic improvement. These opportunities have in the past tended to keep rather low, at least in normal times, the emotional intensity of that identification as compared with the corresponding situations in the Soviet Union and in National Socialist Germany.⁴

New factors have, however, arisen in recent times with the fear of recurrent economic crises, the threat of world revolution as symbolized by the Communist International, the relative disappearance of geographical isolation, and the danger of atomic war. Thus, in the fifth decade of the twentieth century, intensified individual frustrations and anxieties have called forth a more intensive identification, on the part of the individual, with the power and the international policies of the nation. If, therefore, the present trend toward ever increasing instability in domestic and international affairs is not reversed, the United States is likely to partake to an ever increasing extent in those tendencies in modern culture which have found their most extreme manifestations in Soviet Russia and National Socialist Germany, tendencies which make for an ever more complete and intensive identification of the individual with the nation. In this completeness and intensity of identification we have one of the roots of the ferocity and ruthlessness of modern international policies where national aspirations for power clash with each other, supported by virtually total populations with an unqualified dedication and intensity of feeling which in former periods of history only the issues of religion could command.

⁴ Intense nationalistic identification in the United States has been associated in the past mainly with antagonism, on the part of the most insecure sector of the middle class, against certain ethnic groups, such as the Negro or the latest wave of proletarian immigrants.

CHAPTER VII

Elements of National Power

What are the factors which make for the power of a nation on the international scene? What are the components of what we call national power? If we want to determine the power of a nation, what factors are we to take into consideration? Two groups of elements have to be distinguished; those which are relatively stable, and those which are subject to constant change.

I. GEOGRAPHY

The most stable factor upon which the power of a nation depends is obviously geography. For instance, the fact that the continental territory of the United States is separated from other continents by bodies of water three thousand miles wide in the east, and more than six thousand miles wide in the west is a permanent factor which determines the position of the United States in the world. It is a truism to say that the importance of this factor today is not what it was in the times of George Washington or President McKinley. But it is fallacious to assume, as is frequently done, that the technical development of transportation, communications, and warfare has eliminated altogether the isolating factor of the oceans. This factor is certainly less important today than it was fifty or a hundred years ago, but from the point of view of the power position of the United States it still makes a great deal of difference that the United States is separated from the continents of Europe and Asia by wide expanses of water instead of bordering directly on, let us say, France, China, or Russia. In other words, the geographical location of the United States remains a fundamental factor of permanent importance which the foreign policies of all nations must take into account, however different its bearing upon political decisions might be today from what it was in other periods of history.

Similarly, the separation of Great Britain from the European continent by a small body of water, the English Channel, is a factor which Julius Caesar could no more afford to overlook than William the Conqueror, Philip II, Napoleon, or Hitler. However much other factors may have altered its importance throughout the course of history, what was important two thousand

Elements of National Power

years ago is still important today, and all those concerned with the conduct of foreign affairs must take it into account.

What is true of the insular location of Great Britain is true of the geographic position of Italy. The Italian peninsula is separated from the rest of Europe by the high mountain massif of the Alps, and while the valleys of the Alps descend gradually southward toward the north Italian plain, they precipitate abruptly toward the north. This geographical situation has been an important element in the political and military considerations of Italy and of other nations with regard to Italy. For, under all conditions of warfare of which we know, this geographical situation has made it extremely difficult to invade Central Europe from Italy, while it has made it much less difficult to invade Italy from the north. In consequence, invasions of Italy have been much more frequent than invasions by Italy. From Hannibal to General Clark this permanent geographical factor has determined political and military strategy.

The Pyrenees have fulfilled for the international position of Spain a somewhat different, but no less permanent, function. It has been said that Europe ends at the Pyrenees. The Pyrenees, by making Spain difficult of access to the outside world, have indeed functioned as a barrier shutting Spain off from the main stream of the intellectual, social, economic, and political developments which transformed the rest of Europe. Spain has also been by-passed by most of the great political and military conflagrations of continental Europe. This position on the sidelines of continental politics is at least partially the result of that geographical seclusion provided by the mountain barrier of the Pyrenees.

Finally, let us consider the geographical situation of the Soviet Union. The Soviet Union constitutes an enormous land mass which extends over one-seventh of the land area of the earth and is two and one-half times as large as the territory of the United States. While it is about five thousand miles by air from the Bering Straits to Koenigsberg, the capital of what was formerly East Prussia, now called Kaliningrad, it is half that distance from Murmansk at the Barents Sea to Ashkhabad at the northern frontier of Iran. This territorial extension is a permanent source of great strength which has thus far frustrated all attempts at military conquest from the outside. This enormous land mass dwarfed the territory conquered by foreign invaders in comparison with what still remained to be conquered.

Conquest of a considerable portion of a country without prospects for speedy recovery usually breaks the will to resist of the conquered people. This is, as we have seen, the political purpose of military conquest. Similar conquests, especially if, as under Napoleon and Hitler, they did not have a limited objective, but aimed at the very existence of Russia as a nation, had a rather stimulating effect upon Russian resistance. For not only were the conquered parts of Russia small in comparison with those which were left in Russian hands, but the task of the invader became more difficult with every step he advanced. He had to keep an ever greater number of troops supplied over ever lengthening lines of communication deep in a hostile country. Thus geography has made the conquest of Russian territory, as soon as the objec-

Politics among Nations

tives of such conquest become commensurate with the total territory of Russia, a liability for the conquerer rather than an asset. Instead of the conqueror swallowing the territory and gaining strength from it, it is rather the territory which swallows the conqueror, sapping his strength.

(Another geographical factor, however, constitutes at the same time a weakness and an asset for the international position of the Soviet Union. We are referring to the fact that neither high mountains nor broad streams separate the Soviet Union from its western neighbors and that the plains of Poland and Eastern Germany form a natural continuation of the Russian plain.) That means that there exists no natural obstacle to invasion on the western frontier of Russia, either on the part of the Soviet Union or on the part of the Soviet Union's western neighbors. Thus, from the fourteenth century to the present, White Russia and the westernmost part of Russia proper have been the scene of continuous thrusts and counterthrusts and a field of battle where Russia and its western neighbors met. The lack of a natural frontier, that is, of a frontier predetermined, like the Italian or the Spanish, by geographical factors, has been a permanent source of conflict between Russia and the West. Similarly, yet for the opposite reason, the possibility of such a frontier between France and Germany in the form of the Rhine, to which France always aspired and which it had rarely the strength to attain, has been a permanent source of conflict between those two countries since the times of the Romans.

2. NATURAL RESOURCES

(Another relatively stable factor which exerts an important influence upon the power of a nation with respect to other nations is natural resources. To start with the most elemental of these resources, food, a country which is self-sufficient, or nearly self-sufficient, has a great advantage over a nation which is not and must be able to import the foodstuffs which it does not grow, or else starve. It is for this reason that the power and, in times of war, the very existence of Great Britain, which before the Second World War grew only 30 per cent of the food consumed in the British Isles, has always been dependent upon its ability to keep the sea lanes open over which the vital food supplies had to be shipped in. Whenever its ability to import food was challenged, as in the two world wars through submarine warfare and air attacks, the very power of Great Britain was challenged, and its survival as a nation put in jeopardy.)

(For the same reason, Germany, though to a much lesser extent deficient in foodstuffs than Great Britain, in order to survive a war, was bound to pursue three principal goals, either severally or in combination: first, the avoidance of a long war through a speedy victory before its food reserves were exhausted; second, the conquest of the great food producing areas of Eastern Europe; and third, the destruction of British seapower which cut Germany off from access to overseas sources of food. In both world wars, Germany was unable to attain the first and third objectives. It reached the second goal in the First World War too late to be of decisive effect.) Thus the Allied

blockade, by imposing upon the German people privations which sapped their will to resist, was one of the essential factors in the victory of the Allies. In the Second World War Germany became virtually self-sufficient with regard to food, not primarily through conquest, but through the deliberate starvation and the outright killing of millions of people in conquered territories.

(A deficiency in home-grown food has thus been a permanent source of weakness for Great Britain and Germany which they must somehow overcome, or face the loss of their status as great powers. Countries enjoying self-sufficiency, such as the United States and Russia, need not divert their national energies and foreign policies from their primary objectives in order to make sure that their populations will not starve in war. Since they are reasonably free from worry on that count, they have been able to pursue much more forceful and single-minded policies than otherwise would have been possible. Self-sufficiency in food has thus always been a source of great strength.)

Self-sufficiency in food, or lack of it, is a relatively stable factor in national power, but it is sometimes subject to decisive changes. There may be changes in the consumption of food brought about by changing conceptions of nutrition. There may be changes in the technique of agriculture which may increase or decrease the output of agricultural products. The outstanding examples of the influence of changes in the agricultural output upon national power is, however, to be found in the disappearance of the Near East and of North Africa as power centers and in the descent of Spain from a world power in the sixteenth century to a third-rate power in the eighteenth century.

The agricultural systems of the Near East and North Africa were all founded upon irrigation. Even though it could hardly be proved that the decline in the national power of Babylon, of Egypt, and of the Arabs was concomitant with the disorganization of their irrigation systems, this much is certain—the decay of their systems of agriculture, for whatever reason it may originally have occurred, made irreparable the decline of their national power. For the disappearance of regulated irrigation transformed the better part of the arable land of these regions into deserts. It was only in Egypt that the natural irrigation of the Nile preserved a certain measure of fertility even after artificial irrigation had broken down.

As for Spain, while one dates the decline of its power from the destruction of the Armada by Great Britain in 1588, its political downfall became definite only after misrule in the seventeenth and eighteenth centuries had destroyed considerable sections of its agriculture through large-scale deforestation. In consequence, rainfalls ceased, and wide regions of northern and central Spain were transformed into virtual deserts.

What holds true of food is of course also true of those natural resources which are important for industrial production and, more particularly, for the waging of war. The absolute and relative importance which natural resources in the form of raw materials have for the power of a nation depends necessarily upon the technology of warfare which is practiced in a particular period of history. Before the large-scale mechanization of warfare, when hand-to-hand fighting was the prevalent military technique, other factors,

Politics among Nations

such as the personal qualities of the individual soldier, were more important than the availability of the raw materials with which his weapons were made. In that period of history which extends from the beginning of historic time well into the nineteenth century natural resources play a subordinate role in determining the power of a nation. With the increasing mechanization of warfare, which since the industrial revolution has proceeded at a faster pace than in all of the preceding history of mankind, national power has become more and more dependent upon the control of raw materials in peace and war. It is not by accident that the two most powerful nations today, the United States and the Soviet Union, are most nearly self-sufficient in the raw materials necessary for modern industrial production and control at least the access to the sources of those raw materials which they do not themselves produce.

As the absolute importance of the control of raw materials for national power has increased in proportion to the mechanization of warfare, so certain raw materials have gained in importance over others. This has happened whenever fundamental changes in technology have called for the use of new materials or the increased use of old ones. In 1936, a statistician rated the share of a number of basic minerals in industrial production for military purposes and assigned them the following values: coal, 40; oil, 20; iron, 15; copper, lead, manganese, sulphur, 4 each; zinc, aluminum, nickel, 2 each.¹ Half a century before, the share of coal would certainly have been considerably greater, since as a source of energy it had then only small competition from water and wood and none from oil. The same would have been true of iron which then had no competition from light metals and substitutes, such as plastics. Thus it is not by accident that Great Britain, which was self-sufficient in coal and iron, was the one great world power of the nineteenth century.

Since the First World War, oil as a source of energy has become more and more important for industry and war. Most mechanized weapons and vehicles are driven by oil, and, consequently, countries which possess considerable deposits of oil have acquired an influence in international affairs which in some cases can be attributed primarily, if not exclusively, to that possession. "One drop of oil," said Clemenceau during the First World War, "is worth one drop of blood of our soldiers." The emergence of oil as an indispensable raw material has brought about a shift in the relative power of the politically leading nations. The United States and the Soviet Union have become more powerful since they are self-sufficient in this respect, while Great Britain has grown considerably weaker, the British Isles being completely lacking in oil deposits.

What is called the strategic importance of the Near East refers primarily to the oil deposits of the Arabian peninsula. Control over them is an important factor in the distribution of power in the sense that whoever is able to add them to his other sources of raw materials adds that much strength to his own resources and deprives his competitors proportionately. It is for this rea-

¹ Ferdinand Friedensburg, *Die mineralischen Bodenschätze als weltpolitische und militärische Machsfaktoren* (Stuttgart: F. Enke, 1936), p. 175.

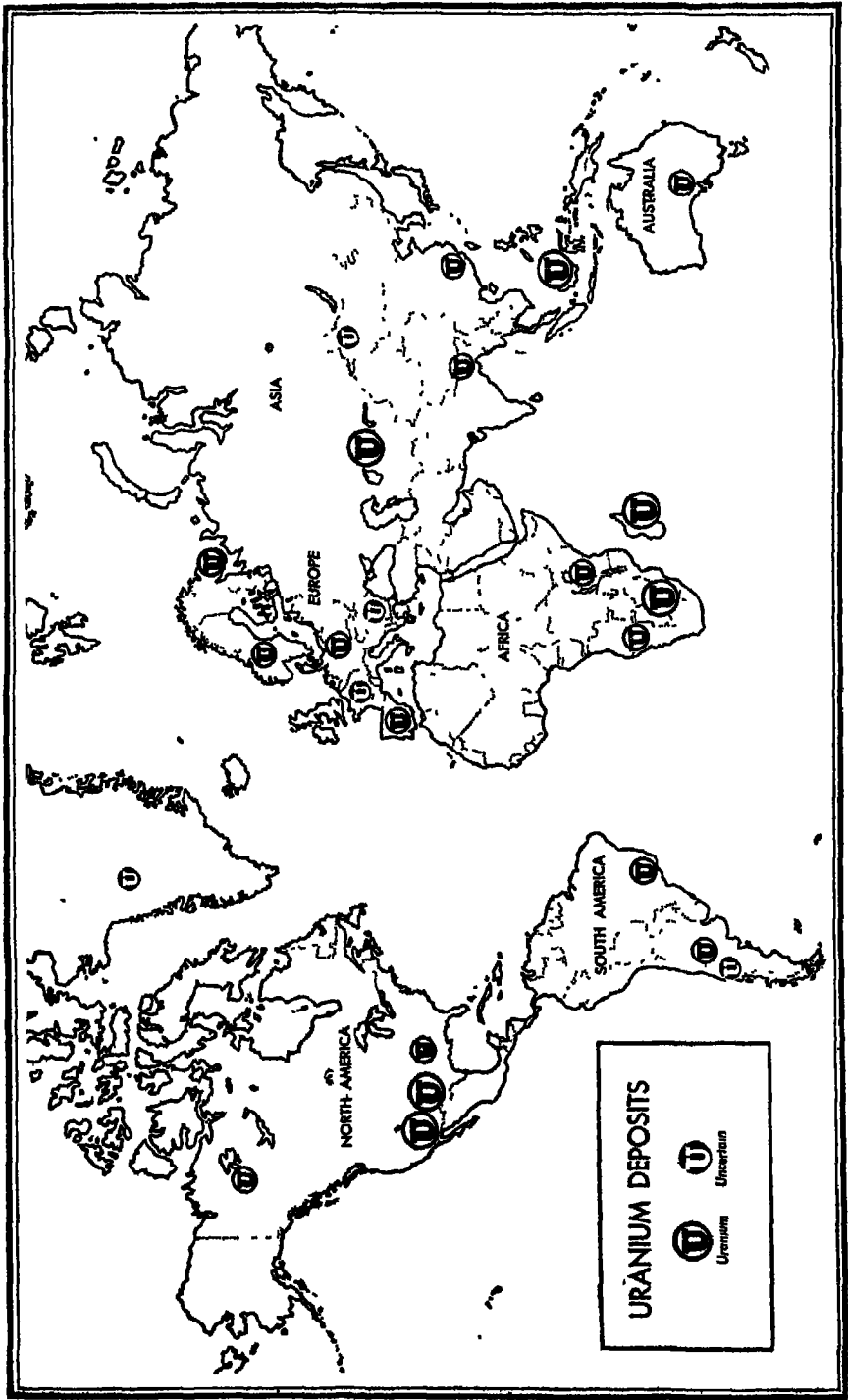

Politics among Nations

son that Great Britain, the United States and, for a time, France have embarked in the Near East upon what has aptly been called "oil diplomacy," that is, the establishment of spheres of influence which gives them exclusive access to the oil deposits of that region. The relatively important part which the states of the Arabian peninsula are able to play in international affairs resides not in anything resembling military strength. Aside from their alleged solidarity with the Moslems of Africa and the rest of Asia, the importance of the Arab states derives exclusively from their control of regions rich in oil.

The influence which the control of raw materials can exert upon national power and the shifts in the distribution of power which it can bring about are demonstrated in our own day most strikingly by the case of uranium. Only a few years ago the control or lack of control of uranium deposits was entirely irrelevant for the power of a nation in international affairs. The author whom we have quoted above,² writing in 1936, did not even mention this mineral in his evaluation of the relative military importance of minerals. The release of atomic energy from the uranium atom and the use of that energy for warfare has at once modified the actual and potential hierarchy of nations from the point of view of their relative power. Nations which control deposits of uranium, such as Canada, Czechoslovakia, the Soviet Union, and the United States, have risen in the power calculations. Others, which neither possess nor have access to deposits of that mineral, have fallen.

3. INDUSTRIAL CAPACITY

The example of uranium illustrates, however, the importance of another factor for the power of a nation, that is, industrial capacity. (The Belgian Congo has vast deposits of high-grade uranium. Yet, while this fact has increased the value of that colony as a prize of war and, therefore, its importance from the point of view of military strategy, it has not appreciably affected the power of Belgium in relation to other nations.) For there does not exist in the Belgian Congo the industrial plant which could put the uranium deposits to industrial and military use. And Belgium is too far away from the Congo for ore to be transported to Belgium for processing in the event of war. On the other hand, for Canada and the United States the possession of uranium signifies an immediate, and for Czechoslovakia and the Soviet Union, a but briefly delayed, enormous increase in power. In these countries, the industrial plants exist, or can be built, or they can easily be used in a neighboring country, where uranium can be transformed into energy to be employed in peace and war.

The same situation can be exemplified by coal and iron. The United States and the Soviet Union have drawn a good deal of their national strength from the possession of vast amounts of these two raw materials because they possess also an industrial plant which can transform them into industrial products. The Soviet Union has built its plant, and is still in the process of building it, at enormous human and material sacrifices. It is will-

² See p. 84, note.

Elements of National Power

ing to make the sacrifices because it recognizes that without the industrial plant it cannot build and maintain a military establishment commensurate with its foreign policy. Without this plant the Soviet Union cannot play the important part in international politics which it intends to play.)

(India follows the United States and the Soviet Union closely as a depository of coal and iron. Its reserves of iron ore in the two provinces of Bihar and Orissa alone are estimated at 2.7 billion tons. Furthermore, India's output of manganese, which is indispensable for the production of steel, was a million tons in 1939, topped only by the output of the Soviet Union. But despite these riches in raw materials without which no nation can attain first rank in modern times, India cannot be classified today as a first-rate power even faintly comparable to the United States and the Soviet Union.) The reason for this lag between the potentialities and actualities of power, which concerns us in the context of this discussion (others will be mentioned later), is the lack of an industrial establishment commensurate with what would be possible in view of the abundance of raw materials. While India can boast of a number of steel mills, such as the Tata Iron Works, which are among the most modern in existence, it has no productive capacity, especially for finished products, which could even be compared with one of the second-rate industrial nations. In 1939, only three million Indians, that is, less than 1 per cent of the total population, were employed in industry. So we see that India possesses in the abundance of some of the key raw materials one of the elements which go into the making of national power, and to that extent it may be regarded as a potentially great power (Actually, however, it will not become a great power so long as it is lacking in other factors without which no nation can attain in modern times the status of a great power. Of these factors industrial capacity is one of the most important.)

(The technology of modern warfare and communications has made the over-all development of heavy industries an indispensable element of national power. Since victory in modern war depends upon the number and quality of highways, railroads, trucks, ships, airplanes, tanks, and equipment and weapons of all kinds, from mosquito nets and automatic rifles to oxygen masks and guided missiles, the competition among nations for power transforms itself largely into competition for the production of bigger, better, and more implements of war. The quality and productive capacity of the industrial plant, the know-how of the working man, the skill of the engineer, the inventive genius of the scientist, the managerial organization — all these are factors upon which the industrial capacity of a nation and, hence, its power in international affairs depends.)

Thus it was inevitable that the leading industrial nations have been identical with the great powers, and a change in industrial rank, for better or for worse, has been accompanied or followed by a corresponding change in the hierarchy of power. So long as Great Britain as an industrial nation had no equal, it was the most powerful nation on earth, the only one which deserved to be called a world power. The decline of France as a power in comparison with Germany, which was unmistakable after 1870 and was only seemingly and temporarily arrested during the decade following the First World War, was in part but the political and military manifestation of the industrial

rouines among Nations

backwardness of France and of the industrial predominance of Germany on the European continent. When we say that the United States is at present the most powerful nation on earth, we base this estimate of American power primarily upon its industrial strength. The *Economist* of London says:

In any comparison of the potential resources of the Great Powers the United States, even before Hitler's war, far outstripped every other nation in the world in material strength, in scale of industrialization, in weight of resources, in standards of living, by every index of output and consumption. And the war, which all but doubled the American national income while it either ruined or severely weakened every other Great Power, has enormously increased the scale upon which the United States now towers above its fellows. Like mice in the cage of an elephant, they follow with apprehension the movements of the mammoth. What chance would they stand if it were to begin to throw its weight about, they who are in some danger even if it only decides to sit down?

There is, indeed, one question that the analyst of power need not spend time in asking about the strength of the United States. If raw material resources, industrial capacity, scientific knowledge, productive know-how, skilled labour — if these alone were the ingredients of power, then the United States could take on the rest of the world single-handed.³

One ought not to forget in this connection that the present American monopoly of the atomic bomb is an outgrowth of American industrial strength. Inventive genius, technological skill, and quality of organization made possible the development of the industrial processes which produced the atomic bomb.

When, on the other hand, one speaks of the weakness of the Soviet Union one has again chiefly the industrial capacity of the country in mind. To quote the *Economist* again:

Those who make their assessments of comparative power by statistical calculations of national production and wealth will not have much difficulty in convincing themselves that it will be a very long time before the Soviet Union is likely to "catch up" with the West in any real sense. Slump or no slump, the average annual volume of productive capital formation in North America will for many decades be much higher than in Soviet Russia. And if the countries of Western Europe — including Germany — should find their way to some co-ordination of production and resources, then the balance of economic power will be irremediably tilted against the Soviets.⁴

4. MILITARY PREPAREDNESS

What gives the factors of geography, natural resources, and industrial capacity their actual importance for the power of a nation is military preparedness. The dependence of national power upon military preparedness is too obvious to need much elaboration. Military preparedness requires a military establishment capable of supporting the foreign policies pursued.

³ *Economist*, May 24, 1947, p. 785. (Reprinted by permission.)

⁴ *Economist*, May 17, 1947, p. 746. (Reprinted by permission.)

Elements of National Power

Such ability derives from a number of factors of which the most significant, from the point of view of our discussion, are technological innovations, and the quantity and quality of the armed forces.

The fate of nations and of civilizations has often been determined by a differential in the technology of warfare for which the inferior side was unable to compensate in other ways. Europe carried its power on the vehicle of a technology of warfare superior to that of the Western Hemisphere, Africa, and the Near and Far East. The addition of infantry, firearms, and artillery to the traditional weapons in the fourteenth and fifteenth centuries spelled a momentous shift in the distribution of power in favor of those who used those weapons before their enemies did. The feudal lords and independent cities, who in the face of these new weapons continued to rely upon cavalry and the castles which until then had been practically immune against direct attack, now found themselves suddenly dislodged from their position of preponderance.

Two events illustrate dramatically this shift in power which politically and militarily marks the end of the Middle Ages and the beginning of the modern era of history. One is the battles of Morgarten in 1315 and of Laupen in 1339, when armies composed of Swiss infantry inflicted disastrous defeats upon feudal cavalry, demonstrating that foot-soldiers recruited from the common people were superior to an aristocratic and expensive army of equestrians. The other is the invasion of Italy by Charles VIII of France in 1494. With infantry and artillery, Charles VIII broke the power of the proud Italian city states, until then secure behind their walls. The seemingly irresistible destructiveness of these new techniques of warfare made an indelible impression upon contemporaries, some of which is reflected in the writings of Machiavelli and other Florentine writers of the time.⁵

The twentieth century has witnessed four major innovations in the technique of warfare. They gave at least a temporary advantage to the side which used them before the opponent did or was able to protect itself against them. There is first, the submarine which was used in the First World War by Germany primarily against British shipping and which seemed to be capable of deciding the war in favor of Germany until Great Britain found in the convoy an answer to that menace. Second, there is the tank, used in considerable and concentrated numbers by the British, but not by the Germans, in the closing phase of the First World War. The tank gave the Allies one of their assets for victory. Third, strategic and tactical co-ordination of the air force with the land and naval forces contributed greatly to the German and Japanese superiority in the initial stages of the Second World War. Pearl Harbor and the disastrous defeats which the British and the Dutch suffered at the hands of the Japanese on land and at sea in 1941 and 1942 were the penalties to be paid for technological backwardness in the face of a more progressive enemy. If one reads the somber review of British defeats which Winston Churchill gave in the secret session of Parliament on April 23,

⁵ See the account by Felix Gilbert, "Machiavelli: The Renaissance of the Art of War," in *Makers of Modern Strategy*, edited by Edward Mead Earle (Princeton: Princeton University Press, 1944), pp. 8, 9.

Politics among Nations

1942,⁹ one is struck by the fact that all these defeats on land, on the sea, and in the air have one common denominator: the disregard or misunderstanding of the change in the technology of warfare brought about by air power. Finally, the monopoly of the atomic bomb, so long as it lasts, gives the United States a great technological advantage in terms of military power.

Aside from the timely use of technological innovations, the quality of military leadership has always exerted a decisive influence upon national power. The power of Prussia in the eighteenth century was primarily a reflection of the military genius of Frederick the Great and of the strategic and tactical innovations introduced by him. The art of warfare had changed between the death of Frederick the Great in 1786 and the battle of Jena in 1806 when Napoleon destroyed the Prussian Army, which in itself was then as good and strong as it had been twenty years before. But, what was more important, military genius was lacking in its leaders who were fighting the battles of Frederick the Great all over again. On the other side military genius was in command, employing new ideas in strategy and tactics. This decided the issue in favor of France.

The Maginot Line psychology of the French General Staff in the period between the two world wars has become a by-word for faulty strategic thinking. While the tendencies of modern technology, especially its trend toward mechanization of transportation and of communications, pointed toward the probability of a war of movement, the French General Staff continued to think in terms of the trench warfare of the First World War. The German General Staff, on the other hand, fully alive to the strategic potentialities of mechanized warfare, planned its campaigns in terms of unprecedented mobility. The conflagration of these two conceptions, not only in France but also in Poland and the Soviet Union, produced in the "blitzkrieg" a superiority of German power which brought Germany close to final victory. The intellectual shock and the military and political devastation caused by the onslaught of Hitler's panzers and divebombers upon the Polish cavalry in 1939 and upon the immobile French Army in 1940 ushered in a new period of military history similar to the one initiated by Charles VIII's invasion of Italy in 1494. But, while the Italian states had nobody to fall back on in order to recover their strength, in the Second World War the superior technology of the United States and the superior manpower of the Soviet Union turned Hitler's strategical innovations to his destruction.

The power of a nation in military terms is also dependent upon the quantity of men and arms and their distribution among the different branches of the military establishment. A nation may have a good grasp of technological innovations in warfare. Its military leaders may excel in the strategy and tactics appropriate to the new techniques of war. Yet such a nation may be militarily and, in consequence, also politically weak if it does not possess a military establishment which in its over-all strength and in the strength of its component parts is neither too large nor too small in view of the tasks which it may be called upon to perform. Must a nation, in order to be strong, possess a large army or is its power not impaired by having, at least in peace-

⁹ *Winston Churchill's Secret Session Speeches* (New York: Simon and Schuster, 1946), pp. 53 ff.

Elements of National Power

time, only a small army, composed of highly trained, specialized units } Have large navies become obsolete, or do battleships and heavy cruisers still fulfill a useful purpose? How large a military establishment can a nation afford in view of its resources and commitments? Does concern for national power require large-scale peacetime production of aircraft and other mechanized weapons, or should a nation, in view of rapid changes in technology, spend its resources on research and on the production of limited quantities of improved types of weapons?

Whether a nation gives the right or the wrong answer to such questions of a quantitative character has obviously a direct bearing upon national power. Can decision in war be forced by one new weapon, such as artillery, as was thought at the turn of the fifteenth century, or the submarine, as the Germans thought in the First World War, or the airplane, as was widely believed in the period between the two world wars, or the atomic bomb, as many believe today? The wrong answers given to some of these questions by Great Britain and France in the period between the two world wars preserved for them the semblance of power in terms of the traditional military conceptions. But those errors brought them to the brink of final defeat in the course of the Second World War, whose military technique required different answers to these questions. Upon the quality of the answers which we give to these and similar questions today will depend the future power of the United States in relation to other nations.

POPULATION

When we turn from material factors and those compounded of material and human elements to the purely human factors which determine the power of a nation, we have to distinguish quantitative and qualitative components. While among the latter we count national character, national morale, and the quality of diplomacy, the former needs to be discussed in terms of size of population.

It would, of course, not be correct to say that the larger the population of a country, the greater the power of that country. For if such an unqualified correlation should exist between size of population and national power, China, with about 450 million inhabitants, would be the most powerful nation on earth, closely followed by India with about 400 million. The Soviet Union with 190 million and the United States with 145 million would run third and fourth, respectively. Though one is not justified in considering a country to be more powerful because its population is greater than that of most other countries, it is still true that no country can remain or become a first-rate power, which does not belong to the more populous nations of the earth. Without a large population it is impossible to establish and keep going the industrial plant necessary for the successful conduct of modern war; to put into the field the large number of combat groups to fight on land, on the sea, and in the air; and, finally, to fill the cadres of the troops, considerably more numerous than the combat troops, which must supply the latter with food, means of transportation and communication, ammunition, and weap-

Politics among Nations

ons.) It is for this reason that imperialistic countries, such as Nazi Germany and Fascist Italy, stimulate population growth with all kinds of incentives, then use that growth as an ideological pretext for imperialistic expansion.

A comparison between the population of the United States and that of Australia and Canada will make clear the relation between size of population and national power. Australia has today, in an area of somewhat less than three million square miles, a population of about seven and one-half million, while the Canadian population, in an area of close to three and one-half million square miles, amounts to about twelve million. The United States, on the other hand, in an area which is smaller than Australia's or Canada's, has a population of 145 million, more than nineteen times larger than Australia's and more than twelve times larger than Canada's. With the population of either Australia or Canada, the United States could never have become the most powerful nation on earth. The waves of mass immigration in the nineteenth and the first two decades of the twentieth centuries, brought to the United States this element of national power. Had the Immigration Law of 1924, limiting immigration to the United States to 150,000 persons a year, been enacted a hundred or even fifty years earlier, thirty-six or twenty-seven million people, respectively, would have been prevented from settling in the United States, and they and their descendants would have been lost to the United States.

In 1824, the population of the United States amounted to close to eleven million. By 1874, it had risen to forty-four million; by 1924, to 114 million. During that century the share of immigration in the growth of the American population was on the average close to 30 per cent, approaching 40 per cent in the period from 1880-1910. This is to say, the most spectacular rise in American population coincides with the absolute and relative peaks of immigration. Free immigration from 1824 and, more particularly, from 1874 to 1924 is, therefore, mainly responsible for the abundance of manpower which has meant so much for the national power of the United States in war and peace. Without this immigration, it is unlikely that the population of the United States would amount to more than half of what it actually is today. In consequence, the national power of the United States would be inferior to what 145 million people make it today.

(Since size of population is one of the factors upon which national power rests and since the power of one nation is always relative to the power of others, the relative size of the population of countries competing for power and, especially, the relative rate of their growth deserve careful attention. A country, for instance, inferior in size of population to its competitor, will view with alarm a declining rate of growth if the population of its competitor tends to increase more rapidly. Such has been the situation of France with regard to Germany since 1870. Since that date, the population of France has increased by four million, whereas Germany has registered a gain of twenty-seven million.) While in 1800 every seventh European was a Frenchman, in 1930 only every thirteenth was a Frenchman. In 1940, Germany had at its disposal about fifteen million men fit for military service, whereas France had only five million.

On the other hand, the manpower ratio between the Soviet Union and

Elements of National Power

Germany is approximately the same as that between Germany and France, that is, three to one, and has been moving in that direction for a long time. Ever since the unification in 1870, Germany has viewed sometimes with alarm, and always with respect, the Russian population figures which show a greater rate of increase than Germany's. Looking at the situation as it existed at the outbreak of the First World War solely from the point of view of population trends, Germany could feel that time was on Russia's side, and France could feel that time was on the side of Germany, while both Austria and Russia, for other reasons already alluded to,⁷ could believe that postponement of the conflict would favor the opponent. Thus all the protagonists, with the exception of Great Britain, had reasons of their own to prefer a war in 1914 to a peaceful settlement which they could not regard as definite, but only as a breathing spell before the unavoidable settling of accounts.

As the shifts in the distribution of power within Europe in recent history have been roughly duplicated by the changes in population trends, so the emergence of the United States as the great power center of the West, taking the place of Western and Central Europe, can be read in the population figures of the respective countries. In 1870, the population of France as well as of Germany exceeded that of the United States. Yet, in 1940, the population of the United States had increased by 100 million while the combined increase in the population of France and Germany in the same period amounted to only thirty-one million.

It is obvious from what has been said thus far that in trying to assess the future distribution of power the prediction of population trends plays an important role. All other factors remaining approximately equal, a considerable decline in the manpower of a nation in comparison with its competitors on the international scene spells a decline in national power, and a considerable increase, under similar conditions, amounts to a gain in national strength. When, toward the end of the nineteenth century, the British Empire was the only world power in existence, its population amounted to about 400 million, that is, approximately one-fourth of the total population of the world. In 1946, it came close to 550 million. Since India's population is estimated at 400 million, these figures illustrate the enormous loss in national power, in terms of population size alone, which the British Empire would suffer in the loss of India.)

Assuming the continuation of past trends without interference by war or natural catastrophes and taking the year 1970 as their point of reference, population experts foresee considerable increases in the populations of the United States, the Soviet Union, the countries of Eastern and Southern Europe, and a considerable decline in the manpower of the nations of Western and Central Europe. According to these forecasts, the population of the United States will have risen by 1970 to at least 155 million, that of the Soviet Union to at least 250 million, those of the eight countries of the Russian sphere of influence from the Baltic to the Bosphorus from close to 90 million in 1948 to about 115 million, while the population of Great Britain will have declined from 47 million in 1945 to about 40 million, and that of France from

⁷ See above, p. 46.

Politics among Nations

42 million in 1938 to 35 million. If this shift in population sizes should come to pass, the Soviet Union will have a larger population than Germany, Great Britain, France, and the rest of Western and Central Europe combined, and the population of the Soviet Union and her satellites will exceed the population of the rest of Europe. If the countries actively engaged in the defense of Western civilization will have been able in 1970 to preserve their present manpower, while the countries in the Russian orbit will by then have increased theirs by about two-fifths, it will be the result of population gains of the United States and of Southern Europe.

From the point of view of population, the position of the United States will in 1970 still show considerable strength in comparison with Western Europe because of the latter's anticipated losses. But compared with the population trend in Latin America, the position of the United States is well on its way to deterioration. Latin America shows the greatest rate of increase of any major region in the world. In 1900, Latin America had an estimated sixty-three million inhabitants to seventy-five million for the United States; in 1948 it was 153 million for Latin America to 145 million for the United States. In 1970, the relation between Latin America and the United States is estimated to be 200-25 million to 155-70 million. The population of Argentina alone more than doubled between 1914 and 1948 and is now close to seventeen million. In the same period the population of the United States has only risen from 99 to 145 million.

It is, however, not sufficient to know the over-all population figures of different countries in order to assess correctly the influence of the population factor upon national power. The age distribution within a given population is an important element in power calculations. All other things being equal, a nation with a relatively large population of maximum potential usefulness for military and productive purposes (roughly between twenty and forty years of age) will have an edge in power over a nation in whose population the older age groups relatively predominate. If the anticipated trends should materialize, the total population of the United States will increase between 1945 and 1970 by close to 20 per cent while the age group of maximum potential usefulness will increase by only 9 per cent. In the same period, the total population of the Soviet Union will increase by about 35 per cent; and the age group under consideration by about 20 per cent.

Echoing Augustus and his successors on the throne of the Roman Empire, Winston Churchill, as British Prime Minister, voiced his alarm at the different situation in which Great Britain finds itself in this respect. He expressed himself on this subject in his radio address of March 22, 1943:

One of the most somber anxieties which beset those who look thirty, or forty, or fifty years ahead, and in this field one can see ahead only too clearly, is the dwindling birth-rate. In thirty years, unless present trends alter, a smaller working and fighting population will have to support and protect nearly twice as many old people; in fifty years the position will be worse still. If this country is to keep its high place in the leadership of the world, and to survive as a great power that can hold its own against external pressures, our people must be encouraged by every means to have larger families,

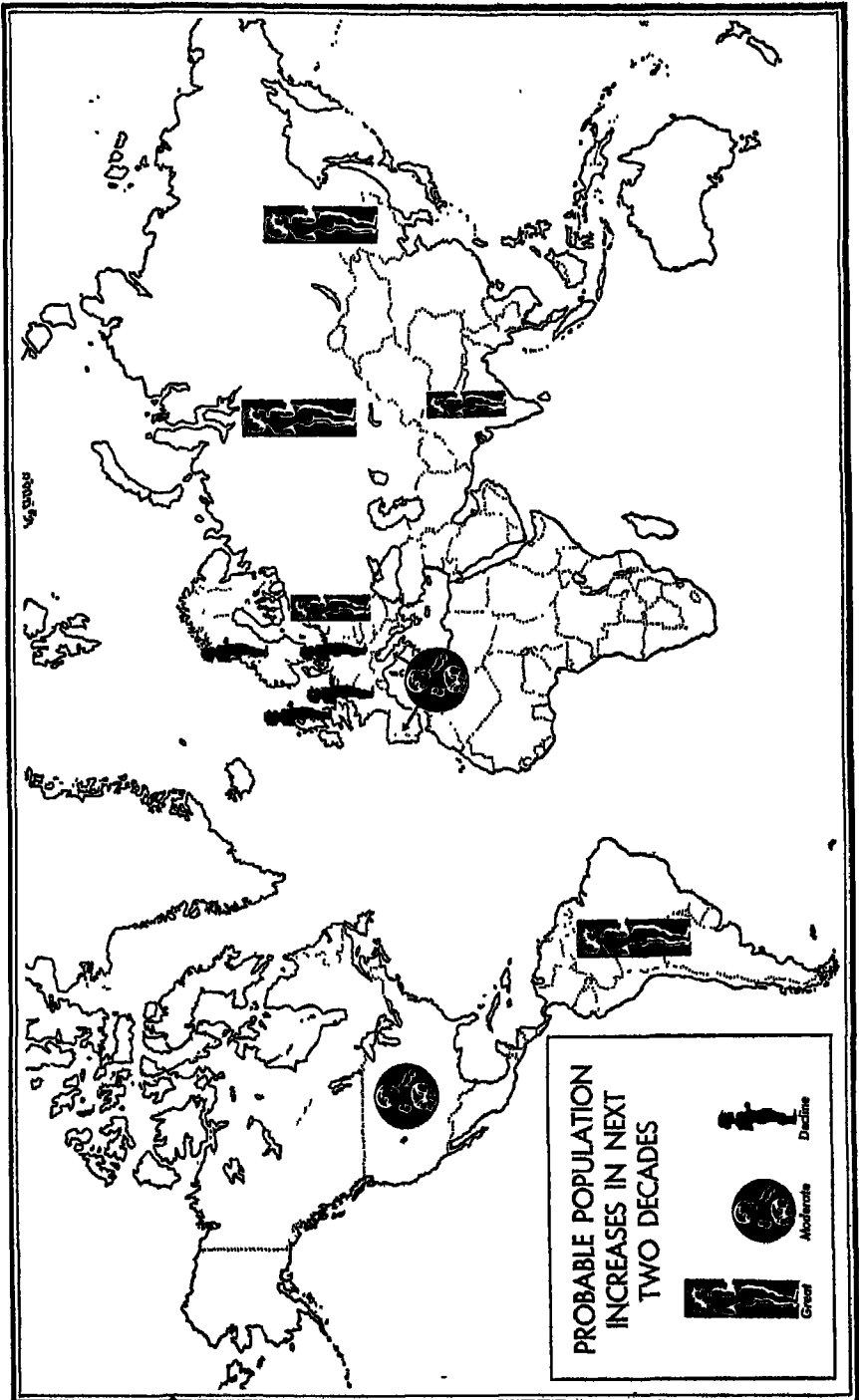

45,000,000

6. NATIONAL CHARACTER

Of the three human factors of a qualitative nature which have a bearing on national power, national character and national morale stand out both for their elusiveness from the point of view of rational prognosis and for their permanent and often decisive influence upon the weight which a nation is able to put into the scales of international politics. We are here not concerned with the question as to what factors are responsible for the development of a national character. We are here only interested in the fact — contested but, it seems to us, incontestable — that certain qualities of intellect and character occur more frequently and are more highly valued in one nation than in another. These qualities set one nation apart from others and they show a high degree of resiliency to change. A few examples, taken at random, will illustrate the point.

Is it not an incontestable fact that, as John Dewey⁸ and many others have pointed out, Kant and Hegel are as typical of the philosophical tradition of Germany, as Descartes and Voltaire are of the French mind, as Locke and Burke are of the political thought of Great Britain, as William James and John Dewey are of the typical American approach to intellectual problems? And can it be denied that these philosophic differences are but expressions, on the highest level of abstraction and systematization, of fundamental intellectual and moral traits which reveal themselves on all levels of thought and action and which give each nation its unmistakable distinctiveness? The mechanistic rationality and the systematic perfection of Descartes' philosophy reappear in the tragedies of Corneille and Racine no less than in the rationalistic fury of Jacobin reform. They reappear in the sterility of the academic formalism which characterizes much of the contemporary intellectual life of France. They reappear in the scores of peace plans, logically perfect but impracticable, in which French statecraft excelled in the period between the two world wars. On the other hand, the trait of intellectual curiosity which Julius Caesar detected in the Gauls has remained throughout the ages a distinctive characteristic of the French mind.

Locke's philosophy is as much a manifestation of British individualism as Magna Carta, due process of law, or Protestant sectarianism. In Edmund Burke, with his undogmatic combination of moral principle and political expediency, the political genius of the British people reveals itself as much as in the Reform Acts of the nineteenth century or in the balance of power politics of Cardinal Wolsey and Canning. What Tacitus said of the political and military propensities of the Germanic tribes fitted the armies of Frederick Barbarossa no less than those of William II and of Hitler. It fits, too, the traditional rudeness and clumsy deviousness of German diplomacy. The authoritarianism, collectivism, and state worship of German philosophy have their counterpart in the tradition of autocratic government, in servile acceptance of any authority so long as it seems to have the will and force to prevail, and, concomitant with it, the lack of civil courage, the disregard of individual rights, and the absence of a tradition of political liberty. The

⁸ *German Philosophy and Politics* (New York: G. P. Putnam's Sons, 1942), *passim*.

Elements of National Power

description of the American national character, as it emerges from De Tocqueville's *Democracy in America*, has not been deprived of its timeliness by the intervention of more than a century. The indecision of American pragmatism between an implicit dogmatic idealism and reliance upon success as a measure of truth is reflected in the vacillations of American diplomacy between the Four Freedoms and the Atlantic Charter, on the one hand, and "dollar diplomacy," on the other.

The existence and stability of a Chinese national character can hardly be denied. As for Russia, the juxtaposition of two experiences, almost a century apart, will provide striking proof of the persistence of certain intellectual and moral qualities.

Bismarck wrote in his memoirs:

At the time of my first stay at St. Petersburg, in 1859, I had an example of another Russian peculiarity. During the first spring days it was then the custom for everyone connected with the court to promenade in the Summer Garden between Paul's Palace and the Neva. There the Emperor had noticed a sentry standing in the middle of a grass plot; in reply to the question why he was standing there, the soldier could only answer, "Those are my orders." The Emperor therefore sent one of his adjutants to the guard-room to make inquiries; but no explanation was forthcoming except that a sentry had to stand there winter and summer. The source of the original order could no longer be discovered. The matter was talked of at court, and reached the ears of the servants. One of them, an older pensioner, came forward and stated that his father had once said to him as they passed the sentry in the Summer Garden: "There he is, still standing to guard the flower; on that spot the Empress Catherine once noticed a snowdrop in bloom unusually early, and gave orders that it was not to be plucked." This command had been carried out by placing a sentry on the spot, and ever since then one had stood there all the year round. Stories of this sort excite our amusement and criticism, but they are an expression of the elementary force and persistence on which the strength of the Russian nature depends in its attitude towards the rest of Europe. It reminds us of the sentinels in the flood at St. Petersburg in 1825, and in the Shipka Pass in 1877; not being relieved, the former were drowned, the latter frozen to death at their posts.⁹

In *Time* magazine of April 21, 1947, we read the following report:

Down Potsdam's slushy Berlinerstrasse stumbled twelve haggard men. . . . Their faces had the pale, creased look of prisoners. Behind them trudged a stubby, broad-faced Russian soldier, Tommy gun crooked in his right arm, the wide Ukrainian steppe in his blue eyes.

Approaching the Stadtbahn station, the group met a stream of men and women hurrying home from work.

An angular, middle-aged woman suddenly sighted the twelve men. She stopped in her tracks, stared wide-eyed at them for a full minute. Then she dropped her threadbare market bag, flew across the street in front of a lumbering charcoal-burning truck and threw herself with a gasping cry upon the third prisoner. Prisoners and passers-by paused and gaped dumbly at the two Rodinesque figures fingering the backs of each other's rough coats and mumbling hysterically: "*Wohin?*" ". . . *weiss nicht.*" "*Warum?*" ". . . *weiss nicht.*"

⁹ *Bismarck, the Man and Statesman, being the Reflections and Reminiscences of Otto, Prince von Bismarck* (New York and London: Harper and Brothers, 1899), I, 250.

Politics among Nations

Slowly the Russian walked around his charges and approached the couple. Slowly a grin covered his face. He tapped the woman on the back. She shuddered. Rigid apprehension spread over the faces of the onlookers, but the Russian rumbled soothingly: "*Keine Angst. Keine Angst.*" (No fear. No tear.) Then he waved the muzzle of his Tommy gun toward the prisoner, who instinctively recoiled a step, and asked: "*Dein Mann?*"

"Ja," replied the woman, tears streaming down her cheeks.

"*Gu-ut,*" grunted the Russian, wrinkling his nose. "*Nimm mit,*" and he gave the bewildered prisoner a gentle shove toward the sidewalk.

The spectators exhaled a mass sigh of relief as the couple stumbled off deliriously, hand in hand. Eleven prisoners, muttering to each other, pushed on down the street past the muttering crowd: "Unpredictable Russians . . . incredible . . . I can't understand . . . I don't understand the Russians."

The Russian shuffled along stoically, gripping a long papirosa between yellow stained teeth as he fished in a pocket for matches. Suddenly his face clouded. He hitched the Tommy gun higher under his arm, took a dirty piece of paper from the wide, ragged sleeve of his shinel, and scowled at it. After a few steps he stuffed the paper back carefully, stared for a moment at the bent backs of the prisoners, then searched the strained faces of a new load of commuters just leaving the station.

With no fuss, the Russian stepped up to a youngish man with a briefcase under his arm and a dirty brown felt hat pulled over his ears, and commanded: "*Eeh, Dul Komm!*" The German froze, casting a terrified glance over his shoulder at the frightened stream of men and women who were trying not to see or hear. The Russian waved his Tommy gun and curled his lip. "*Komm!*" He pushed his petrified recruit roughly into the gutter.

Again the prisoners were twelve. The Russian's face relaxed. With a third sputtering match he lighted his papirosa and placidly blew smoke toward the tense Germans scurrying home through the gathering dusk.¹⁰

Between these two episodes a great revolution intervened, interrupting the historic continuity on practically all levels of national life. Yet the traits of Russian national character emerged intact from the holocaust of that revolution. Even so thorough a change in the social and economic structure, in political leadership and institutions, in the ways of life and thought has not been able to affect the "elementary force and persistence" of the Russian character which Bismarck found revealed in his experience and which reveal themselves in the Russian soldier of Potsdam as well.

(National character cannot fail to influence national power; for those who act for the nation in peace and war, formulate, execute, and support its policies, elect and are elected, mold public opinion, produce and consume — they all bear to a greater or lesser degree the imprint of those intellectual and moral qualities which make up the national character. The "elementary force and persistence" of the Russians, the individual initiative and inventiveness of the Americans, the undogmatic common sense of the British, the discipline and thoroughness of the Germans are some of the qualities which will manifest themselves, for better or for worse, in all the individual and collective activities in which the members of a nation can engage. In consequence of the differences in national character, the German and Russian governments, for

¹⁰ *Time*, April 21, 1947, p. 32. (Used by permission of *Time*, Copyright Time Inc., 1947.)

Elements of National Power

instance, have been able to embark upon foreign policies which the American and British governments would have been incapable of pursuing, and vice versa.) Anti-militarism, aversion to standing armies and to compulsory military service are permanent traits of the American and British national character. Yet the same institutions and activities have for centuries stood high in the hierarchy of values of Prussia, from where their prestige spread over all of Germany. In Russia the tradition of obedience to the authority of the government and the traditional fear of the foreigner have made large permanent military establishments acceptable to the population.

(Thus the national character has given Germany and Russia an initial advantage in the struggle for power, since they could transform in peacetime a greater portion of their national resources into instruments of war. On the other hand, the reluctance of the American and British peoples to consider such a transformation, especially on a large scale and with respect to manpower, except in an obvious national emergency, has imposed a severe handicap upon the tactics and strategy of American and British foreign policy.) Governments, such as that of the Nazis, can plan, prepare, and wage war at the moment of their choosing. They can, more particularly, start a preventive war whenever it seems to be most propitious for their cause. Governments, such as the American, are in this respect in a much more difficult situation and have much less freedom of action. Restrained as they are by the innate anti-militarism of their peoples, they must pursue a more cautious course in foreign affairs. Frequently the military strength actually at their disposal will not be commensurate to the political commitments which their concern for the national interest imposes upon them. In other words, they will not have the armed might sufficient to back up their policies. When they go to war, they will generally do so on the terms of their enemies. They must rely upon other traits in the national character and upon other compensating factors, such as geographical location and industrial potential, to carry them over the initial period of weakness and inferiority to ultimate victory. Such can be the effects, for good or evil, of the character of a nation.

The observer of the international scene who attempts to assess the relative strength of different nations must take national character into account, however difficult it may be to assess correctly so elusive and intangible a factor. Failure to do so will lead to errors in judgment and policies, such as the depreciation of the recuperative force of Germany after the First World War and the underestimation of Russian staying power in 1941-42. The Treaty of Versailles could restrict Germany in all the other implements of national power, such as territory, sources of raw materials, industrial capacity, and military establishment. But it could not take away from Germany those qualities of intellect and character which enabled it within a period of two decades to rebuild what it had lost and to emerge as the strongest single military power in the world. The virtually unanimous opinion of the military experts who in 1942 gave the Russian Army only a few more months of resistance, may have been correct in purely military terms, such as military strategy, mobility, industrial resources, and the like. Yet this expert opinion was obviously mistaken in underrating that factor of "elementary force and persistence" which better judgment has recognized as the great source of Russian

Politics among Nations

strength in its dealings with Europe. The pessimism which in 1940 denied Great Britain a chance for survival had its roots in a similar neglect or misreading of the national character of the British people.

We have already mentioned in another context the contempt in which American power was held by the German leaders before the Second World War.¹¹ It is interesting to note that exactly the same mistake, and for the same reason, was made by the German leaders during the First World War. Thus, in October 1916, the German Secretary of the Navy estimated the significance of the United States joining the Allies to be "zero," and another German minister of that period declared in a parliamentary speech, after the United States had actually entered the First World War on the side of the Allies: "The Americans cannot swim and they cannot fly, the Americans will never come." In both cases, the German leaders underestimated American power by paying attention exclusively to the quality of the military establishment at a particular moment, to the anti-militarism of the American character, and to the factor of geographical distance. They disregarded completely the qualities of the American character, such as individual initiative, gift for improvisation, and technical skill, which, together with the other material factors and under favorable conditions, might more than outweigh the disadvantages of geographical remoteness and of a dilapidated military establishment.

On the other hand, the belief of many experts, at least until the battle of Stalingrad, in the invincibility of Germany drew its strength from the material factors as well as from certain aspects of the German national character which seemed to favor total victory. These experts neglected other aspects of the national character of the German people, in particular their lack of moderation. From the emperors of the Middle Ages and the warlords of the 'Thirty Years' War to William II and Hitler, this lack of moderation has proved to be the one fatal weakness of the German national character. Unable to restrain goal and action within the limits of the possible, the Germans have time and again squandered and ultimately destroyed the national power of Germany built upon other material and human factors.

7. NATIONAL MORALE

More elusive and less stable, but no less important than all the other factors in its bearing upon national power, is what we propose to call national morale. National morale is the degree of determination with which a nation supports the foreign policies of its government in peace or war. It permeates all activities of a nation, its agricultural and industrial production as well as its military establishment and diplomatic service. In the form of public opinion it provides an intangible factor without whose support no government, democratic or autocratic, is able to pursue its policies with full effectiveness, if it is able to pursue them at all. Its presence or absence and its qualities reveal themselves particularly in times of national crisis, when either the exist-

¹¹ See above, p. 59.

Elements of National Power

ence of the nation is at stake or else a decision of fundamental importance must be taken upon which the survival of the nation might well depend.)

While certain traits of the national character might easily manifest themselves in the national morale of the people at a certain moment of history, such as the common sense of the British, the individualism of the French, the tenacity of the Russians, no conclusion can be drawn from the character of a nation about what the morale of that nation might be under certain contingencies. Their national character seems to qualify the American people to a particular degree for playing the role of a first-rate power under the conditions of the mid-twentieth century. Yet nobody can foresee with any degree of certainty what the national morale of the American people would be like under the conditions which prevailed in the different belligerent countries of Europe and Asia during certain phases of the Second World War and of the postwar years. Nor is there a way of anticipating the reactions of the British people to a repetition of the experiences of the Second World War. They stood up under the "blitz" and the V-weapons once. Could they stand up under them a second time? And what about the atomic bomb? Similar questions can be asked of all nations, and no rational answers are forthcoming.

American national morale, in particular, has been in recent years the object of searching speculation at home and abroad; for American foreign policy and, through it, the weight of American power in international affairs is to a peculiar degree dependent upon the moods of American public opinion, as they express themselves in the votes of Congress, election results, polls, and the like. Would the United States join the United Nations? Would Congress pass the British loan? Would Congress support the Marshall plan for Europe? How far was Congress willing to go in giving assistance to Turkey? If Turkey were invaded by a foreign army, would a majority of Congress be willing to pass a declaration of war? The main factor upon which the answers to these questions depended or depend is the state of national morale at the decisive moment.

The national morale of any people will obviously break at a certain point. The breaking point is different for different peoples and under different circumstances. Some peoples will be brought close to the breaking point by tremendous and useless losses in war, such as the French after the Nivelle offensive of 1917 in the Champagne. One great defeat will suffice to undermine the national morale of others, such as the defeat which the Italians suffered in 1917 at Caporetto and which cost them three hundred thousand men in prisoners and the same number in deserters. The morale of others, such as the Russians in 1917, will break under the impact of a combination of tremendous war losses in men and territory and the mismanagement of an autocratic government. The morale of others will only slowly decline and, as it were, corrode at the edges and not break at all in one sudden collapse, even when exposed to a rare combination of governmental mismanagement, devastation, invasion, and a hopeless war situation. Such was the case of the Germans in the last stage of the Second World War, when a number of military leaders and former high officials gave up the lost cause while the masses of the people fought on until practically the moment of Hitler's sui-

Politics among Nations

cide. This persistence of German morale in 1945 under most unfavorable circumstances is particularly illustrative of the unpredictability of such collective reactions. Under much less severe circumstances the national morale of Germany collapsed in November 1918, a precedent which should have presaged a similar collapse of German morale sometime in the summer of 1944, after the Allied invasion of France.

While national morale is subjected to its ultimate test in war, it is important whenever a nation's power is brought to bear on an international problem. It is important partly because of the anticipated effects of national morale upon military strength, partly because national morale influences the determination with which the government pursues its foreign policies. Any segment of the population which feels itself permanently deprived of its rights and of full participation in the life of the nation will tend to have a lower national morale, to be less "patriotic" than those who do not suffer from such disabilities. The same is likely to be true of those whose vital aspirations diverge from the permanent policies pursued by the majority or by the government. Whenever deep dissensions tear a people apart, the popular support which can be mustered for a foreign policy will always be precarious and will be actually small if the success or failure of the foreign policy has a direct bearing upon the issue of the domestic struggle.

Autocratic governments, which in the formulation of their policies do not take the wishes of the people into account, cannot rely upon much popular support for their foreign policies. Such was the case in countries like czarist Russia and the Austrian monarchy. The example of Austria is particularly instructive. Many of the foreign policies of that country, especially with respect to the Slavic nations, aimed at weakening the latter in order better to be able to keep in check the Slavic nationalities living under Austrian rule. In consequence, these Slavic nationalities tended to be at best indifferent to the foreign policies of their own government and at worst to support actively the policies of Slavic governments directed against their own. Thus it is not surprising that during the First World War whole Slavic units of the Austro-Hungarian Army went over to the Russians. The government dared to use others only against non-Slavic enemies, such as the Italians. For similar reasons, during the First World War the German Army used Alsatian units against the Russians, and Polish units against the French.

The Soviet Union had a similar experience of lack of morale during the Second World War when certain units composed of Ukrainians and Cossacks deserted to the Germans and fought the Russian armies. Great Britain has had the same experience with India, whose national energies have but unwillingly and with reservations supported the foreign policies of its alien master, if they did not, like Bose and his followers during the Second World War, come to the assistance of the alien master's enemy. Napoleon and Hitler had to learn to their dismay that among the spoils of foreign conquest popular support of the conqueror's policies is not necessarily to be found. The amount and strength of the support which Hitler, for instance, found among the conquered peoples of Europe was in inverse ratio to the quality of the national morale of the particular people.

Any country with deep and unbridgeable class divisions will find its na-

Elements of National Power

tional morale in a precarious state. French power before and during the Second World War suffered from this weakness. From the time of Hitler's ascent to power, the vacillating foreign policies of the French governments, following each other in rapid succession and concealing their impotence behind the ideologies of a status quo which they were unwilling and incapable of defending, had already weakened the national morale of the French people as a whole. The crises of 1938-39, with the ever renewed threat of war and general mobilizations to meet it, followed by Hitler's successes, demobilizations, and an increasingly precarious peace, had contributed powerfully to the general decay of French morale. While there was decay everywhere, there was actual collapse only in two important sectors of French society. On the one hand, faced with certain limitations of their powers by social legislation, considerable groups of the French upper classes rallied to the cry, "Rather Hitler than Blum!" Although Hitler threatened the position of France in Europe and its very existence as a nation, these groups were unable to give whole-hearted support to the French foreign policy opposing Hitler. After the conquest of France they favored the domination of France by Hitler rather than its liberation from the foreign dictator. On the other hand, the Communists, for different reasons, undermined the national morale of France so long as Hitler fought only the capitalists of the West. It was only after he had attacked the Soviet Union that they contributed new strength to French national morale by being found in the forefront of the resistance against the invader.

However unpredictable the quality of national morale, especially at a moment of great crisis, there are obvious situations where national morale is likely to be high, while under certain different conditions the odds are in favor of a low state of national morale. One can say, in general, that the more closely identified a people are with the actions and objectives of their government, especially, of course, in foreign affairs, the better are the chances for national morale to be high, and vice versa. Thus it can surprise only those who mistakenly think of the modern totalitarian state in terms of the autocracies of the eighteenth and nineteenth centuries that in Nazi Germany national morale was high almost to the last. It declined slowly rather than breaking in one sudden collapse as it did in November 1918. The great bulk of the Russian people, despite the greatest hardships in war and peace, have consistently shown a high degree of national morale.

The modern totalitarian state has been able to fill the gap between government and people, a gap which was typical of the monarchies of the eighteenth and nineteenth centuries, through the use of democratic symbols, totalitarian control of public opinion, and policies actually or seemingly benefiting the people. Practically all national energies flow into the channels chosen by the government, and the identification of the individual with the state, which we have recognized as one of the characteristics of modern politics,¹² reaches under the stimulation of totalitarianism the intensity of religious fervor. Therefore, so long as totalitarian governments are, or seem to be, successful, or can at least hold out hope for success, they can

¹² See above, pp. 75 ff.

Politics among Nations

count upon the determined support of their peoples for the foreign policies which they pursue.

What totalitarianism can achieve only by force, fraud, and deification of the state, democracy must try to accomplish through the free interplay of popular forces, guided by a wise and responsible government. Where the government is unable to prevent the degeneration of this interplay into class, racial, or religious conflicts, tending to split the national community into warring groups, national morale is likely to be low, at least among the victimized groups if not among the people as a whole. The policies of France before and during the Second World War illustrate this point. So does the weakness of the foreign policies in peace and war of countries where feudal aristocracies control the government and oppress the people, such as Spain, Portugal, and numerous Latin-American countries. The governments of such nations can never choose and pursue their foreign objectives with any degree of determination, even at the risk of war, because they can never be sure of the support of their peoples. They constantly fear lest the domestic opposition exploit difficulties and reverses in the international field for the purpose of overthrowing the regime. Where, however, a government speaks as the mouthpiece, and acts as the executor, of the popular will, national morale is likely to reflect the real identity between popular aspirations and governmental actions. The national morale of Denmark under the German occupation from 1940 to the end of the Second World War illustrates this point no less strikingly than did the national morale of Germany until the defeat at Stalingrad.

In the last analysis, then, the power of a nation from the point of view of its national morale resides in the quality of its government. A government that is truly representative, not only in the sense of parliamentary majorities, but above all in the sense of being able to translate the inarticulate convictions and aspirations of the people into international objectives and policies, has the best chance to marshal the national energies in support of those objectives and policies. The adage that free men fight better than slaves can be amplified into the proposition that nations well governed are likely to have a higher national morale than nations poorly governed. The quality of government is patently a source of strength or weakness with respect to most of the factors upon which national power depends, especially in view of the influence of governmental activities upon natural resources, industrial capacity, and military preparedness. For the quality of national morale, the quality of government takes on a special importance. Whereas it operates upon the other elements of national power as one among several influences, all more or less manageable by human action, it is the only tangible factor among intangibles which accounts for the quality of national morale. Without national morale, national power is either nothing but material force or else a potentiality which awaits its realization in vain. Yet the only means of deliberately improving national morale lie in the improvement of the quality of government. All else is a matter of chance.

8. THE QUALITY OF DIPLOMACY¹⁸

(Of all the factors which make for the power of a nation, the most important, and of the more unstable, is the quality of diplomacy.) All the other factors which determine national power are, as it were, the raw material out of which the power of a nation is fashioned. The quality of a nation's diplomacy combines those different factors into an integrated whole, gives them direction and weight, and awakens their slumbering potentialities by giving them the breath of actual power. The conduct of a nation's foreign affairs by its diplomats is for national power in peace what military strategy and tactics by its military leaders are for national power in war. It is the art of bringing the different elements of national power to bear with maximum effect upon those points in the international situation which concern the national interest most directly.

(Diplomacy, one might say, is the brains of national power, as national morale is its soul. If its vision is blurred, its judgment defective, and its determination feeble, all the advantages of geographical location, of self-sufficiency in food, raw materials, and industrial production, of military preparedness, of size and quality of population will in the long run avail a nation little. A nation which can boast of all these advantages, but not of a diplomacy commensurate with them, may achieve temporary successes through the sheer weight of its natural assets. In the long run, it is likely to squander the natural assets by activating them incompletely, haltingly, and wastefully for the nation's international objectives.)

In the long run, such a nation must yield to a nation whose diplomacy is able to make the most of whatever other elements of power are at its disposal, thus making up through its own excellence for deficiencies in other fields. By using the power potentialities of a nation to best advantage, a competent diplomacy can increase the power of a nation beyond what one would expect it to be in view of all the other factors combined. Often in history the Goliath without brains or soul has been smitten and slain by the David who had both. (Diplomacy of high quality will bring the ends and means of foreign policy into harmony with the available resources of national power. It will tap the hidden sources of national strength and transform them fully and securely into political realities. By giving direction to the national effort, it will in turn increase the independent weight of certain factors, such as industrial potential, military preparedness, national character, and morale. It is for this reason that national power is apt to rise to its height fulfilling all its potentialities, particularly in times of war, when ends and means of policy are clearly laid out.)

The United States, in the period between the two world wars, furnishes a striking example of a potentially powerful nation playing a minor role in world affairs because its foreign policy refused to bring the full weight of its potential strength to bear upon international problems. As far as the

¹⁸ By the term "diplomacy," as used in the following pages, we refer to the formation and execution of foreign policy on all levels, the highest as well as the subordinate. On the subject matter discussed here, see also below, Part Ten.

Politics among Nations

power of the United States on the international scene was concerned, the advantages of geography, natural resources, industrial potential, and size and quality of population might as well have not existed at all, for American diplomacy proceeded as though they did not exist.

The transformation which American foreign policy has undergone in recent years has not answered definitively the question whether, and to what extent, American diplomacy is willing and able to transform the potentialities of national power into political actualities. In an article significantly entitled, "Imperialism or Indifference," the London *Economist* poses the same question for our time. After enumerating the factors which, taken by themselves, would make the United States the most powerful nation on earth, the *Economist* continues:

But though these things are essential ingredients, they are not all that it takes to make a Great Power. There must also be the willingness, and the ability, to use economic resources in support of national policy. The rulers of Soviet Russia . . . are not likely, at least for a generation to come, to have nearly as good cards in their hands as the Americans. But the nature of their system of concentrated power and iron censorship enables them to play a forcing game. The Americans' hand is all trumps; but will any of them ever be played? And for what purpose? ¹⁴

The classic example of a country which, while in other respects hopelessly outclassed, returned to the heights of power chiefly by virtue of its brilliant diplomacy is France in the period from 1890 to 1914. After its defeat in 1870 at the hands of Germany, France was a second-rate power, and Bismarck's statecraft, by isolating it, kept it in that position. With Bismarck's dismissal in 1890, Germany's foreign policy turned away from Russia and was unwilling to alleviate Great Britain's suspicion. French diplomacy took full advantage of those mistakes of German foreign policy. In 1894, France added a military alliance to the political understanding reached with Russia, in 1891; in 1904 and 1912, it entered into informal agreements with Great Britain. The constellation of 1914 which found France aided by potent allies and Germany deserted by one and burdened with the weakness of the others was in the main the work of a galaxy of brilliant French diplomatists: Camille Barrère, Ambassador to Italy, Jules Cambon, Ambassador to Germany, Paul Cambon, Ambassador to Great Britain, Maurice Paléologue, Ambassador to Russia.

In the period between the two world wars, Rumania owed its ability to play a role in international affairs much superior to its actual resources chiefly to the personality of one man, its Foreign Minister Titulescu. Similarly, so small and precariously located a country as Belgium owed a great deal of the power it was able to exercise during the nineteenth century to two shrewd and active kings, Leopold I and Leopold II. The ups and downs of British power are closely connected with changes in the quality of British diplomacy. Cardinal Wolsey, Castlereagh and Canning signify the summits of British diplomacy as well as of British power, while Lord North and Neville Chamberlain stand for the decline of both. What would the power of

¹⁴ *Economist*, May 24, 1947, p. 785. (Reprinted by permission.)

Elements of National Power

France have been without the statecraft of Richelieu, Mazarin, and Talleyrand? What would Germany's power have been without Bismarck? Italy's without Cavour? And what does the power of the young American Republic not owe to Franklin, Jefferson, Madison, Jay, the Adamases, its ambassadors and secretaries of state?

(Nations must rely upon the quality of their diplomacy to act as a catalyst for the different factors which constitute their power. In other words, these different factors, as they are brought to bear upon an international problem by diplomacy, are what is called a nation's power. Therefore, it is of the utmost importance that the good quality of the diplomatic service be constant.) And constant quality is best assured by dependence upon tradition and institutions rather than upon the sporadic appearance of outstanding individuals. It is to tradition that Great Britain owes the relative constancy of its power from Henry VIII to the First World War. Whatever the whims and shortcomings of its kings and ministers may have been, the traditions of its ruling class and, in recent times, its professional foreign service were able, a few notable exceptions notwithstanding, to mold the prerequisites of national power, with which Great Britain was endowed, into the greatness of its actual power. It is no accident that when, due to the diplomacy of Stanley Baldwin and Neville Chamberlain, British power reached its lowest point in centuries, the professionals of the Foreign Office had little influence upon the conduct of British foreign policy, and that the two men mainly responsible for it were, in terms of family tradition, businessmen and newcomers to the aristocracy which for centuries had ruled Great Britain. In Winston Churchill, the scion of a ruling family, the aristocratic traditions were again brought to bear upon the national power of Great Britain. Today the institutional excellence of the British foreign service reveals itself in the skill with which Great Britain retreats from India and brings its commitments all over the world into harmony with the reduced resources of its national power.

On the other hand, Germany owed its power to the demoniac genius of two men, Bismarck and Hitler. Since Bismarck's personality and policies made it impossible for traditions and institutions to develop which might have been able to perpetuate the intelligent conduct of Germany's foreign policy, his disappearance from the political scene in 1890 was the signal for a deep and permanent drop in the quality of German diplomacy. The consequent deterioration of Germany's international position culminated in the military predicament with which the First World War confronted it. In the case of Hitler, the strength and weakness of German diplomacy lay in the mind of the Führer himself. The victories which German diplomacy won from 1933 to 1940 were the victories of one man's mind, and the deterioration of that mind was a direct cause of the disasters which marked the last years of the Nazi regime. The national suicide of Germany in the last months of the Second World War, when military resistance had become a futile gesture paid for in hundreds of thousands of lives and the ruin of cities, and Hitler's suicide in the last stage of the war — the self-extinction, in other words, of Germany's national power and of the life of its leader — are both the work of one man. That man was unfettered by those traditions and in-

Politics among Nations

stitutional safeguards by which healthy political systems try to provide for continuity in the quality of diplomacy and thus tend to inhibit the spectacular successes of genius as well as the abysmal blunders of madmen.

So far as continuity in the quality of the conduct of foreign affairs is concerned, the United States stands between the continuous high quality of British diplomacy and the traditional low quality, interrupted by short-lived triumphs, of German foreign policy. With an unchallengeable superiority in material and human resources at its disposal, American diplomacy in the Western Hemisphere could not fail to be successful in some measure, regardless of the quality of its foreign policy. The same has been true to a lesser degree in the relations between the United States and the rest of the world. The "big stick" in the form of the material superiority of the United States spoke its own language, regardless of whether American diplomacy spoke in a soft or loud voice, in articulate or confused terms, with or without a clearly conceived purpose. The brilliance of the first decades of American diplomacy was followed by a long period of mediocrity, if not ineptitude, interrupted under the impact of great crises by two brief periods of great achievements under Woodrow Wilson and Franklin D. Roosevelt. While American diplomacy was thus lacking in the institutional excellence of the British, it had the benefit of material conditions which even poor statecraft could hardly dissipate. Furthermore, it could draw upon a national tradition, as formulated in Washington's Farewell Address and, more particularly, in the Monroe Doctrine. The guidance of this tradition would protect a poor diplomacy from catastrophic blunders and make a mediocre diplomacy look better than it actually was.

CHAPTER VIII

Evaluation of National Power

I. THE TASK OF EVALUATION

Such are the different factors which determine the power of nations on the international scene. It is the task of those responsible for the foreign policy of a country and of those who mold public opinion with regard to international affairs to evaluate correctly the bearing of these different factors upon the power of their own country and of other countries as well, and this task must be performed for both the present and the future. What is the probable influence of what is called the unification of the armed services upon the quality of the military establishment of the United States? What effect will the use of atomic energy have upon the industrial capacity of the United States and of other countries? What will the victory of either the Kuomintang or the Communists in the civil war mean for the industrial capacity and national morale of China? What will political independence mean for the national morale of India? What is the significance of the revival of German industry for the national power of Germany? Will re-education be able to change the German national character? How will the national character of the people of Argentina react upon the political philosophies, methods, and objectives of the Perón regime? In what ways does the advancement of the Russian sphere of influence to the Elbe River affect the geographical position of the Soviet Union? Will this or that reorganization or change in the personnel of the State Department strengthen or weaken the quality of American diplomacy? These are some of the questions which must be answered correctly if a nation's foreign policy is to be successful.

Yet these questions referring to changes in one particular factor are not the most difficult to answer. There are others which concern the influence of changes in one factor upon other factors, and here the difficulties increase and the pitfalls multiply. What is, for instance, the import of the modern technology of warfare for the geographical position of the United States? How, in other words, do guided missiles and fast-flying aircraft affect the geographical isolation of the United States from other continents? To what degree will the United States lose, and to what degree will it retain, its traditional inviolability to overseas attack? What do the same technological developments, together with the American monopoly of the atomic bomb, mean in view of the geographical character of Russian territory? To what

Politics among Nations

extent have these factors reduced the protective function of the wide expanses of the Russian plains? And what, in this context, of the protection which the Channel has since the beginning of British history afforded to Great Britain? What will the industrialization of Argentina, China, and India signify for the military strength of these countries? What is the relative importance of the American Army, Navy, and Air Force in view of changes in the technology of warfare? What does the comparatively slow increase of the American population in the next two decades and the more rapid increase of the populations of Latin America, India, China, and the Soviet Union portend for the industrial capacity and military strength of the respective countries? How will fluctuations in industrial production affect the national morale of the United States, the Soviet Union, Germany, Great Britain, and France? Will the British national character preserve its traditional qualities under the impact of the fundamental changes which the industrial capacity, the economic organization, the military strength, and the geographical isolation of Great Britain are undergoing?

The task of the analyst of national power does not, however, stop here. He must yet try to answer another group of questions of a still higher order of difficulty. These questions concern the comparison of one power factor in one country with the same or another power factor in another country. In other words, they concern the relative weight of changes in the individual components of the power of different nations for the over-all power relations of these different nations. If one considers, for instance, the relative power of the United States and the Soviet Union at a particular moment, let us say in 1948, the question arises as to how the different power factors on either side add up and to which side they give a superiority in power and in what respects? Does the monopoly of the atomic bomb, a bigger navy, a smaller but technically superior air force, and a smaller and probably qualitatively inferior army on the side of the United States add up to military superiority over the Soviet Union which has a small and qualitatively inferior navy, a larger and qualitatively inferior air force, and a larger, well-trained and organized, yet poorly equipped army? To what extent does the quantitatively and qualitatively superior industrial capacity of the United States compensate for the probable inferiority in over-all military effectiveness? What are the respective strengths and weaknesses of the highly concentrated American industries with their great vulnerability to air attack and their great ease of communication and of the dispersed Russian industries, partly secret in location and character, yet faced with great difficulties in transportation? What power does the Soviet Union derive from the exposure of Western Europe to ideological and military penetration from the East? What weakness is inflicted upon it by its exposure to air and naval attack from the Pacific? What is the significance, in terms of the respective power positions, of the operation in the United States of groups subservient to Russian foreign policy, and of the enforced homogeneity of Russian public opinion? What is the impact upon the national power of the United States of a democratic form of government and of a nontotalitarian economic system in comparison with the totalitarian political and economic organization of the Soviet Union?

Evaluation of National Power

These and similar questions must be asked and answered with regard to all countries which play an active role on the international scene. The relative influence of the different factors upon national power must be determined with regard to all countries which compete with each other in the field of international politics. Thus one ought to know whether France is stronger than Italy and in what respects. One ought to know what the assets and liabilities in terms of the different power factors of India or China are with respect to the Soviet Union, of Indonesia with regard to the Netherlands, of Argentina with regard to Chile, and so on.

The task of power computation is still not completed. In order to gain an at least approximately true picture of the distribution of power among several nations, the power relations, as they seem to exist at a particular moment in history, must be projected into the future. To effect this it is not enough to ask oneself: What are the power relations between the United States and the Soviet Union in 1948, and what are they likely to be in 1950 or 1960? For decisions on international matters based upon, and referring to, the power relations between the United States and the Soviet Union have to be taken not only in 1948, 1950, and 1960, but every day. And every day changes, however small and imperceptible at first, in the factors making for national power add an ounce of strength to this side and take a grain of might away from the other.

On the relatively stable foundation of geography the pyramid of national power rises through different gradations of instability to its peak in the fleeting element of national morale. All the factors which we have mentioned, with the exception of geography, are in constant flux, influencing each other and influenced in turn by the unforeseeable intervention of nature and man. Together they form the stream of national power, rising slowly and then flowing on a high level for centuries, as in Great Britain; or rising steeply and falling sharply from its crest, such as was the case with Germany; or, as with the United States and the Soviet Union, rising steeply and facing the uncertainties of the future. To chart the course of the stream and of the different currents which compose it and to anticipate the changes in their direction and speed is the ideal task of the observer of international politics.

It is an ideal task and, hence, incapable of achievement. Even if those responsible for the foreign policy of a nation were endowed with superior wisdom and unfailing judgment and could draw upon the most complete and reliable sources of information, there would be unknown factors to spoil their calculations. They could not foresee natural catastrophes, such as famines and epidemics, man-made catastrophes, such as wars and revolutions, inventions and discoveries, the rise and disappearance of intellectual, military, and political leaders, the thoughts and actions of such leaders, not to speak of the imponderables of national morale. In short, even the wisest and best informed of men would still have to face all the contingencies of history and of nature. Actually, however, the assumed perfection in intellect and information is never available. Not all the men who inform those who make decisions in foreign affairs are well informed, and not all the men who make decisions are wise. Thus the task of assessing the relative power of nations for the present and for the future resolves itself into a series of hunches of

Politics among Nations

which some will certainly turn out to be wrong while others might be proved by subsequent events to have been correct. The success or failure of a foreign policy, in so far as it depends upon such power calculations, is determined by the relative importance of the right and wrong hunches made by those responsible for a particular foreign policy of a particular country as well as by those who conduct the foreign affairs of other countries. Sometimes the mistakes in the assessment of power relations committed by one country are compensated for by the mistakes committed by another. Thus the success of the foreign policy of a country may be due less to the accuracy of its own calculations than to the greater errors of the other side.

2. TYPICAL ERRORS OF EVALUATION

Of all the errors which nations can commit in evaluating their own power and the power of other nations, three types are so frequent and illustrate so well the intellectual pitfalls and practical risks inherent in such evaluations that they deserve some further discussion. The first disregards the relativity of power by erecting the power of one particular nation into an absolute. The second takes for granted the permanency of a certain factor which has in the past played a decisive role, thus overlooking the dynamic change to which most power factors are subject. The third attributes to one single factor a decisive importance to the neglect of all the others. In other words, the first error consists in not correlating the power of one nation to the power of other nations. The second consists in not correlating actual power at one time to possible power at some future time. The third consists in not correlating one power factor to others of the same nation.

a) The Absolute Character of Power

When we refer to the power of a nation by saying that this nation is very powerful and that nation is weak, we always imply a comparison. In other words, the concept of power is always a relative one. When we say that the United States is at present the most powerful nation on earth, what we are actually saying is that if we compare the power of the United States with the power of all other nations, as they exist at present, we find that the United States is more powerful than any of the others.

It is one of the most elemental and frequent errors in international politics to neglect this relative character of power and to deal instead with the power of a nation as though it were an absolute. The evaluation of the power of France in the period between the two world wars is a case in point. At the conclusion of the First World War, France was the most powerful nation on earth from a military point of view. France was so regarded up to the very moment when in 1940 its actual military weakness became obvious in a crushing defeat. The newspaper headlines from the beginning of the Second World War in September 1939 to the defeat of France in the summer of 1940 tell most eloquently the story of that misjudgment of French military power. During that period of the so-called "phony" war the German armies were

Evaluation of National Power

supposed not to dare to attack the French because of the latter's superior strength, and on numerous occasions the French were reported to have broken through the German lines. At the root of that misjudgment there was the misconception that the military power of France was not relative to the military power of other nations, but something absolute. French military strength, taken by itself, was at least as great in 1939 as it was in 1919; France was therefore believed to be as strong a nation in 1939 as it had been in 1919.

The fatal error of that evaluation lies in the unawareness of the fact that in 1919 France was the strongest military power on earth only in comparison with other nations of which its closest competitor, Germany, was defeated and disarmed. The supremacy of France as a military power was, in other words, not an intrinsic quality of the French nation which might be ascertained in the same way in which one might detect the national characteristics of the French people, their geographic location, and natural resources. That supremacy was, on the contrary, the result of a peculiar power constellation, that is, of the comparative superiority of France as a military power over the other nations. The quality of the French Army as such had indeed not decreased between 1919 and 1939. Measured in numbers and quality of troops, artillery, airplanes, and staff work, French military power had not deteriorated. Thus even so keen an expert on international affairs as Winston Churchill, comparing the French Army of the late thirties with the French Army of 1919, could declare in 1937 that the French Army was the only guarantee of international peace.

He and most of his contemporaries compared the French Army of 1937 with the French Army of 1919, which had gained its reputation only from comparison with the German Army of the same year, instead of comparing the French Army of 1937 with the German Army of the same year. Such a comparison would have shown that the power constellation of 1919 was reversed in the late thirties. While the French military establishment still was essentially as good as it had been in 1919, Germany's armed forces were now vastly superior to the French. What exclusive concern with French armed might — as if it were an absolute quality — could not reveal, a comparison of the relative military strength of France and Germany might have indicated, and grave errors in political and military judgment might thus have been avoided.

A nation which at a particular moment in history finds itself at the peak of its power is particularly exposed to the temptation to forget that all power is relative. It is likely to believe that the superiority it has achieved is an absolute quality to be lost only through stupidity or neglect of duty. A foreign policy, however, based on such assumptions, runs grave risks; for it overlooks the fact that the superior power of that nation is only in part the outgrowth of its own qualities, while it is in part the result of the qualities of other nations compared with its own.

The predominance of Great Britain from the end of the Napoleonic Wars to the beginning of the Second World War was due mainly to its insular protection from attack and its quasi-monopolistic control of the main sea lanes of the world. In other words, Great Britain, during that period of

Politics among Nations

history, had in comparison with other nations two advantages which no other nation possessed. Great Britain's insular location has not changed and its navy is still, with the exception of the American, stronger than any other. But other nations have acquired weapons, in the form of airplanes and directed missiles, which obviate to a considerable extent the two advantages from which the power of Great Britain had grown. This change in the power position of Great Britain sheds light upon the tragic dilemma which confronted Neville Chamberlain in the years before the Second World War. Neville Chamberlain understood the relativity of Britain's power. He knew that not even victory in war could stop its decline. It was Chamberlain's ironic fate that his attempts to avoid war at any price made war inevitable, and that he was forced to declare the war he dreaded as the destroyer of British power. It is, however, a testimony to the wisdom of British statecraft that since the end of the Second World War British foreign policy has by and large been conscious of the decline of British power relative to the power of other nations. British statesmen have been aware of the fact that while the British Navy, taken by itself, may be as strong as it was ten years ago and the channel is as broad and unruly as it always was, other nations have increased their power to such an extent as to deprive those two British assets of much of their effectiveness.

b) The Permanent Character of Power

Related to the first error, but proceeding from a different intellectual operation, is the one which, while it may well be aware of the relativity of power, singles out a particular power factor or power relation, basing the estimate upon the assumption that this factor or relation is immune to change.

We have already had occasion to refer to the miscalculation which up to 1940 saw in France the first military power on earth. Those who held this view erected French power into an absolute and forgot that the eminence of that power in the twenties was the result of comparison and that it would have to be tested by comparison in order to ascertain its quality in 1940. Conversely, when the actual weakness of France revealed itself in military defeat, there developed a tendency in France and elsewhere to expect that weakness to endure. France was treated with neglect and disdain as though it were bound to be weak forever.

The evaluation of Russian power has followed a similar pattern, only in reverse historical order. From 1917 to the Battle of Stalingrad in 1943 the Soviet Union was treated as if its weakness at the beginning of the twenties was bound to persist whatever change might occur in other fields. Thus the British military mission which was sent to Moscow in the summer of 1939 to conclude a military alliance with the Soviet Union in anticipation of the approaching war with Germany, conceived its task with a view of Russian power which might have been justified ten or twenty years before. This miscalculation was an important element in the mission's failure. On the other hand, immediately after the victory of Stalingrad and under the impact of the Soviet Union's aggressive foreign policy, the belief in the permanent

Evaluation of National Power

invincibility of the Soviet Union and in the permanency of its predominance in Europe was widely held as a dogma.

There is a seemingly ineradicable inclination in our attitude toward the Latin-American countries to assume that the unchallengeable superiority of the colossus of the North, which has existed since the nations of the Western Hemisphere won their independence, was almost a law of nature which population trends, industrialization, political and military developments might modify, but could not basically alter. Similarly, since for centuries the political history of the world has been determined by members of the white races while the colored races were in the main the objects of that history, it is difficult for members of all races alike to visualize a situation where the political supremacy of the white races might no longer exist, where, indeed, the relation between the races might even be reversed. It is especially the demonstration of seemingly irresistible military power which exerts a strange fascination over the minds of those who are given to hasty prophecies rather than to cautious analysis. It makes them believe that history has come to a standstill, as it were, and that today's holders of unchallengeable power cannot fail to enjoy this power tomorrow and the day after. Thus, when in 1940 and 1941 the power of Germany was at its peak, it was widely believed that the Nazi domination of Europe was established forever. When the hidden strength of the Soviet Union startled the world in 1943, Stalin was saluted as the future master of Europe and Asia. In the postwar years the American monopoly of the atomic bomb has given rise to the conception of the "American Century," a world dominion based upon American power.¹

The root of all those tendencies to believe in the absolute character of power or to take the permanency of a particular power constellation for granted lies in the contrast between the dynamic, ever changing character of the power relations between nations, on the one hand, and the human intellect's thirst for certainty and security in the form of definite answers, on the other. Confronted with the contingencies, ambiguities, and uncertainties of the international situation, we search for a definite comprehension of the power factors upon which our foreign policy is based. We all find ourselves in the position of Queen Victoria, who, after dismissing Palmerston whose unpredictable moves on the international scene had exasperated her, asked her new Prime Minister, John Russell, for "a regular programme embracing these different relations with other powers." The answers we receive are not always as wise as the one John Russell gave Queen Victoria. "It is very difficult," he replied, "to lay down any principles from which deviations may not frequently be made."² Yet a misguided public opinion is only too prone to blame statesmen for such deviations, deeming compliance with principles, without regard for the distribution of power, to be a virtue rather than a vice.

¹ The most spectacular contemporary victim of the fallacy of the permanent character of power is James Burnham. See George Orwell, "Second Thoughts on James Burnham," *Polemic*, No. 3, May 1946, pp. 13 ff.; "James Burnham Rides Again," *Anti-Communist Review*, Vol. 7, No. 2, Summer 1947, pp. 315 ff.

² Robert W. Seton Watson, *Britain in Europe, 1789-1914* (New York: The Macmillan Company, 1937), p. 53.

Politics among Nations

What the observer of international politics needs in order to reduce to a minimum the unavoidable errors in the calculations of power is a creative imagination, immune from the fascination which the preponderant power of the moment so easily imparts, able to detach itself from the superstition of an inevitable trend in history, open to the possibilities for change which the dynamics of history entail. A creative imagination of this kind would be capable of that supreme intellectual achievement which consists in detecting under the surface of present power relations the germinal developments of the future, in combining the knowledge of what is with the hunch as to what might be, and in condensing all these facts, symptoms, and unknowns into a chart of probable future trends which is not too much at variance with what actually will happen.

c) The Fallacy of the Single Factor

The third typical error in assessing the power of different nations—attributing to a single factor an overriding importance to the detriment of all the others—can best be illustrated in three of its manifestations most consequential in modern times: geopolitics, nationalism, and militarism.

GEOPOLITICS. Geopolitics is a pseudo-science erecting the factor of geography into an absolute which is supposed to determine the power and, hence, the fate of nations. Its basic conception is space. Yet, while space is static, the peoples living within the spaces of the earth are dynamic. According to geopolitics, it is a law of history that peoples must expand by "conquering space," or perish, and that the relative power of nations is determined by the mutual relation of the conquered spaces. This basic conception of geopolitics was first expressed in a paper by Sir Halford Mackinder, "The Geographical Pivot of History," read before the Royal Geographical Society in London in 1904. "As we consider this rapid review of the broader currents of history, does not a certain persistence of geographical relationship become evident? Is not the pivot region of the world's politics that vast area of Euro-Asia which is inaccessible to ships, but in antiquity lay open to the horse-riding nomads, and is today to be covered with a network of railways?" This is the "Heartland" of the world which stretches from the Volga to the Yangtze and from the Himalayas to the Arctic Ocean. "Outside the pivot area, in a great inner crescent, are Germany, Austria, Turkey, India and China, and in an outer crescent, Britain, South Africa, Australia, the United States, Canada and Japan." The "World-Island" is composed of the continents of Europe, Asia, and Africa, around which the lesser land areas of the world are grouped. From this geographical structure of the world geopolitics draws the conclusion that "Who rules east Europe commands the Heartland; who rules the Heartland commands the World-Island; who rules the World-Island commands the World."^a

Mackinder, on the basis of this analysis, foresaw the emergence of Russia or of whatever nation would control the territory described above as the

^a Sir Halford J. Mackinder, *Democratic Ideals and Reality* (New York: Henry Holt and Company, 1919), p. 150.

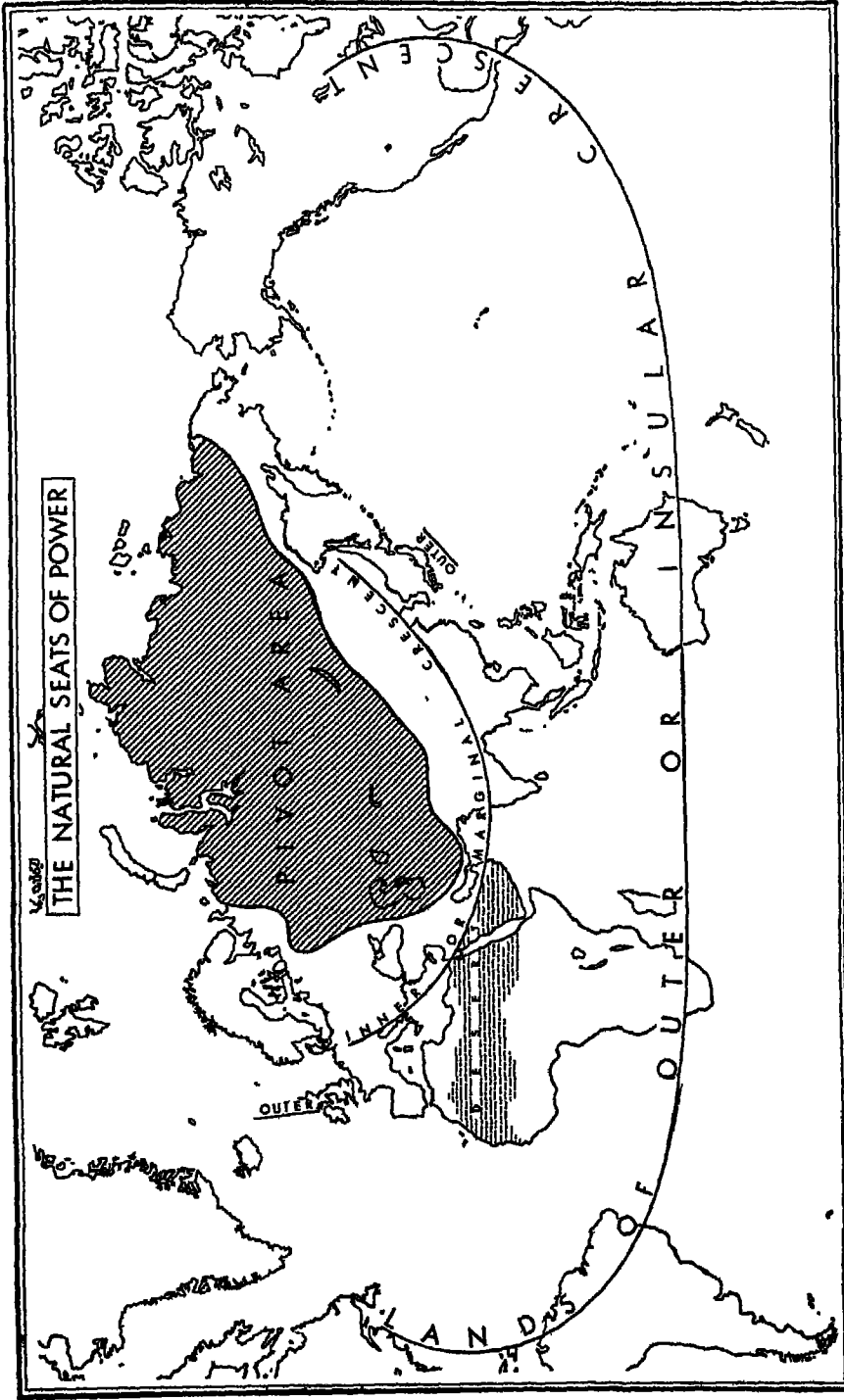

NOTE: Pivot Area is wholly continental; Outer Crescent, wholly oceanic; Inner Crescent, partly oceanic, partly continental. [Based on Sir Halford Mackinder's map, *Geographical Journal*, XXIII (1904), 435.]

Politics among Nations

dominating world power. The German geopoliticians, under the leadership of General Haushofer, who exerted an important influence upon the power calculations and foreign policies of the Nazi regime, were more specific. They postulated an alliance with the Soviet Union or else the conquest of Eastern Europe by Germany in order to make Germany the predominant power on earth. It is obvious that this postulate cannot be directly inferred from the geopolitical premise. Geopolitics only tells us what space is destined, because of its location relative to other spaces, to harbor the master of the world. It does not tell us to what particular nation that mastery will fall. Thus the German school of geopolitics, eager to demonstrate that it was the mission of the German people to conquer the "Heartland," the geographical seat of world dominion, combined the geopolitical doctrine with the argument of population pressure. The Germans were a "people without space" and the "living space" which they must have in order to live beckons to be conquered in the empty plains of Eastern Europe.

Geopolitics, as presented in the writings of Mackinder and Fairgrieve, had given a valid picture of one aspect of the reality of national power, a picture seen, as it were, from the exclusive and, therefore, distorting angle of geography. In the hands of Haushofer and his disciples, geopolitics was transformed into a kind of political metaphysics to be used as an ideological weapon in the service of the international aspirations of Germany.⁴

NATIONALISM. Geopolitics is the attempt to understand the problem of national power exclusively in terms of geography and degenerates in the process into a political metaphysics couched in a pseudo-scientific jargon. Nationalism tries to explain national power exclusively or at least predominantly in terms of national character and degenerates in the process into the political metaphysics of racism. As geographical location is for geopolitics the one determinant of national power, so membership in a nation is for nationalism. This membership may be defined in terms of language, culture, common origin, race, or in the decision of the individual to belong to the nation. But no matter how it is defined, it always entails as its essence partaking in certain qualities, called the national character, which the members of a particular nation have in common and by which they differ from the members of other nations. The preservation of the national character and, more particularly, the development of its creative faculties is the supreme task of the nation. In order to fulfill it, the nation needs power which will protect it against other nations and stimulate its own development. In other words, the nation needs a state. "One nation — one state" is thus the political postulate of nationalism; the national state is its ideal.

But though the nation needs the power of the state for the sake of its preservation and development, the state needs the national community in order to maintain and increase its power. Particularly in the nationalistic philosophy of Germany, as, for instance, in the writings of Fichte and Hegel,

⁴ The ideological connotations of isolationism and the solidarity of the Western Hemisphere are akin to geopolitics in that they derive a conception of foreign policy from distorted or fictional geographical factors. The distortion of isolationism has already been pointed out in the text; as to the fictional character of the geographical unity of the Western Hemisphere, see Eugene Staley, "The Myth of the Continents," in *Compass of the World*, edited by Hans W. Wegert and Vilhjalmur Stefansson (New York: The Macmillan Company, 1944), pp. 89-108.

Evaluation of National Power

the national character or spirit appears as the soul, and the political organization of the state as the body, of the national community which needs both in order to fulfill its mission among the other national communities. The feeling of affinity, the participation in a common culture and tradition, the awareness of a common destiny, which are of the essence of national sentiment and patriotism, are transformed by nationalism into a political mysticism in which the national community and the state become superhuman entities, apart from, and superior to, their individual members, entitled to absolute loyalty and, like the idols of old, deserving of the sacrifice of men and goods.

This mysticism reaches its apogee in the racist worship of the national character. The nation is here identified with a biological entity, the race, which, so long as it remains pure, produces the national character in all its strength and splendor. The dilution of the race through the admixture of alien elements corrupts the character of the nation and thus weakens the power of the state. The homogeneity of the nation and the purity of the race thus appear as the very essence of national power, and for the latter's sake national minorities must either be absorbed or ejected. In the end, the national character of one's own nation comes to be regarded as the repository of all those qualities—courage, loyalty, discipline, industry, endurance, intelligence, and faculty for leadership—the possession of which justifies the exercise of supreme power over other nations and at the same time makes the exercise of such power possible. The overestimation of the qualities of one's own nation, which is characteristic of all nationalism, leads in the concept of the master race to the very idolatry of the national character. The master race is by virtue of the superior quality of its national character destined to rule the world. It has by virtue of these qualities the potential power to exercise world-wide dominion, and it is the task of statemanship and of military conquest to transform those slumbering potentialities into the actualities of world empire.

The intellectual and political excesses of nationalism and of its degenerate offspring, racism, have shocked and repelled the non-nationalistic mind to a much greater degree than the excesses of geopolitics. The latter have in the main been limited to Germany and were perpetrated in an esoteric language. The excesses of nationalism, on the other hand, are the logical outgrowth of a secular religion which has engulfed in the fanaticism of a holy war of extermination, enslavement, and world conquest only certain countries, yet has left its mark on broad sections of the population in all countries. Since nationalism has singled out the national character as the pivot of its political philosophy, program, and action, critical observers have frequently tended to go to the other extreme and have denied the existence of a national character altogether. Intent upon demonstrating the mythical and subjective essence of nationalism, they have been anxious to show that its alleged empirical basis, the national character, is also nothing but a myth.

One can readily agree with the critics of nationalism and racism that the allegedly inevitable determination of the national character by the "blood," that is, the common biological characteristics of the members of a certain group, is a political fabrication without any basis in fact. One can

Politics among Nations

also agree that the absolute constancy of the national character, deriving from the immutability of the qualities of a pure race, belongs in the realm of political mythology. The existence of the United States as a nation and its assimilative powers offer convincing proof of the fallacy of both assertions. On the other hand, to deny altogether the existence of the national character and its bearing upon national power runs counter to the facts of experience, of which we have given a few samples above.⁵ Such denial would be an error no less detrimental to a correct assessment of the power of a nation in relation to others than the nationalistic deification of the national character has proved to be.

MILITARISM. Militarism commits the same type of error with respect to military preparedness which geopolitics and nationalism commit with regard to geography and national character. Militarism is the conception that the power of a nation consists primarily, if not exclusively, in its military strength, conceived especially in quantitative terms. The largest army, the biggest navy, the biggest and fastest air force in the world become the predominant, if not the exclusive, symbols of national power. While this type of mistaken thinking has been popularized and systematized to a particular degree in Germany, it ought not to be assumed that it has not found wide acceptance in other countries as well.

Nations whose military strength lies in navies rather than in large standing armies are wont to point with abhorrence to the militarism of Germany, France, or the Soviet Union without recognizing that they have developed their peculiar brand of militarism. Influenced by writers such as Mahan, they have emphasized out of all proportion the importance of the size and quality of their navies for national power. In the United States there is a widespread tendency to overemphasize the technological aspects of military preparedness, such as the speed and the range of airplanes and the uniqueness of weapons. The average German is misled by masses of goose-stepping soldiers. The average Russian experiences the supremacy of Soviet power, derived from space and population, in the throngs filling the vastness of Red Square on May Day. The typical Englishman loses his sense of proportion in the presence of the gigantic form of a dreadnought. Many Americans succumb to the fascination which emanates from the "secret" of the atomic bomb. All these attitudes to military preparedness have in common the mistaken belief that all that counts, or at least what counts most for the power of a nation, is the military factor conceived in terms of numbers and quality of men and weapons.⁶

⁵ See above, pp. 96 ff.

⁶ This aspect of militarism is impressively described by R. H. Tawney, *The Acquisitive Society* (New York: Harcourt, Brace and Company, 1920), p. 44: "Militarism is the characteristic, not of an army, but of a society. Its essence is not any particular quality or scale of military preparation, but a state of mind, which, in its concentration on one particular element in social life, ends finally by exalting it until it becomes the arbiter of all the rest. The purpose for which military forces exist is forgotten. They are thought to stand by their own right and to need no justification. Instead of being regarded as an instrument which is necessary in an imperfect world, they are elevated into an object of superstitious veneration, as though the world would be a poor insipid place without them, so that political institutions and social arrangements and intellect and morality and religion are crushed into a mold made to fit one activity, which in a sane society is a subordinate activity, like the police, or the maintenance of prisons, or the

Evaluation of National Power

From the militaristic error follows inevitably the equation of national power with material force. To speak loudly and carry a big stick, to rephrase Theodore Roosevelt's famous dictum, is indeed the preferred method of militaristic diplomacy. The proponents of this method are unaware that it is sometimes wise to speak softly and carry a big stick; that it is sometimes even wise to leave the big stick at home where it is available when needed. In its exclusive concern with military strength, militarism is contemptuous of the intangibles of power. Without them a powerful nation may frighten other nations into submission or it may conquer by sheer overwhelming force, but it cannot rule what it has conquered; for it cannot gain voluntary acceptance for its rule. In the end, the power of militarism must yield to a power tempered with self-restraint which seeks the effectiveness of national power in the infrequency of its military use. The failures of Spartan, German, and Japanese militarism as over against the triumphs of the Roman and British policies of empire-building show the disastrous practical results of that intellectual error which we call militarism.

Thus the error of militarism gives new sharpness to the structure and contours of national power. Militarism—and here is the essence of its error—is unable to understand the paradox that a maximum of material power does not necessarily mean a maximum of over-all national power. A nation which throws the maximum of material power which it is capable of mustering into the scales of international politics will find itself confronted with the maximum effort of all its competitors to equal or surpass its power. It will find that it has no friends, but only vassals and enemies. Since the emergence of the modern state system in the fifteenth century, no single nation has succeeded in imposing its will for any length of time upon the rest of the world by sheer material force alone. No nation that has tried the ways of militarism has been strong enough to withstand the other nations' combined resistance which the fear of its superior material power had called into being.

The only nation which in modern times could maintain a continuous position of preponderance owed that position to a rare combination of potential superior power, a reputation for superior power, and the infrequent use of that superior power. Thus Great Britain was able, on the one hand, to overcome all serious challenges to its superiority because its self-restraint gained powerful allies and, hence, made it actually superior. On the other hand, it could minimize the incentive to challenge it because its superiority did not threaten the existence of other nations. When Great Britain stood at the threshold of its greatest power, it heeded the warning of its greatest political thinker—a warning as timely today as when first uttered in 1793:

Among precautions against ambition, it may not be amiss to take one precaution against our *own*. I must fairly say, I dread our *own* power and our *own* ambition; I dread our being too much dreaded. It is ridiculous to say we are not men, and that, as men, we shall never wish to aggrandize ourselves in some way

cleansing of sewers, but which in a militarist state is a kind of mystical epitome of society itself. "Militarism . . . is fetich worship. It is the prostration of men's souls before, and the laceration of their bodies to appease an idol." (Reprinted by permission of the publisher.)

Politics among Nations

or other. Can we say that even at this very hour we are not invidiously aggrandized? We are already in possession of almost all the commerce of the world. Our empire in India is an awful thing. If we should come to be in a condition not only to have all this ascendant in commerce, but to be absolutely able, without the least control, to hold the commerce of all other nations totally dependent upon our good pleasure, we may say that we shall not abuse this astonishing and hitherto unheard-of power. But every other nation will think we shall abuse it. It is impossible but that, sooner or later, this state of things must produce a combination against us which may end in our ruin.⁷

⁷ Edmund Burke, "Remarks on the Policy of the Allies with Respect to France." *Works* (Boston: Little, Brown, and Company, 1899), IV, 457.

PART FOUR

LIMITATIONS
OF INTERNATIONAL POWER:
THE BALANCE OF POWER

CHAPTER IX

*The Balance of Power*¹

The aspiration for power on the part of several nations, each trying either to maintain or to overthrow the status quo, leads of necessity to a constellation which is called the balance of power and to policies which aim at preserving it. We are using the term "of necessity" advisedly. For here again we are confronted with the basic misconception which has impeded the understanding of international politics and has made us the prey of illusions. This misconception asserts that men have a choice between power politics and its necessary outgrowth, the balance of power, on the one hand, and a different, better kind of international relations, on the other. It insists that a foreign policy based on the balance of power is one among several possible foreign policies and that only stupid and evil men will choose the former and reject the latter.

It will be shown in the following pages that the balance of power in international affairs is only a particular manifestation of a general social principle to which all societies composed of a number of autonomous units owe the autonomy of their component parts; that the balance of power and policies aiming at its preservation are not only inevitable, but an essential stabilizing factor in a society of sovereign nations; and that the instability of the international balance of power is due not to the faultiness of the principle, but to the particular conditions under which the principle must operate in a society of sovereign states.

I. SOCIAL EQUILIBRIUM

The concept of "equilibrium" as a synonym for "balance" is commonly employed in many sciences—physics, biology, economics, sociology, and political science. It signifies stability within a system composed of a number of autonomous forces. Whenever the equilibrium is disturbed either by an

¹ The term "balance of power" is used in the text in four different meanings: (1) as a policy aimed at a certain state of affairs, (2) as an actual state of affairs, (3) as an approximately equal distribution of power, (4) as any distribution of power. Whenever the term is used without qualification, it refers to an actual state of affairs in which power is distributed among several nations with approximate equality. For the term referring to any distribution of power, see below, pp. 158, 159.

Politics among Nations

outside force or by a change in one or the other elements composing the system, the system shows a tendency to re-establish either the original or a new equilibrium.) Thus equilibrium exists in the human body. While the human body changes in the process of growth, the equilibrium persists as long as the changes occurring in the different organs of the body do not disturb the latter's stability. This is especially so if the quantitative and qualitative changes in the different organs are proportionate to each other. When, however, the body suffers a wound or loss of one of its organs through outside interference or experiences a malignant growth or a pathological transformation of one of its organs, the equilibrium is disturbed, and the body tries to overcome the disturbance by re-establishing the equilibrium either on the same or a different level from the one which obtained before the disturbance occurred.²

The same concept of equilibrium is used in a special social science, such as economics, with reference to the relations between the different elements of the economic system, e.g., between savings and investments, exports and imports, supply and demand, costs and prices. It also applies to society as a whole. Thus we search for a proper balance between different geographical regions, such as the East and the West, the North and the South; between different kinds of activities, such as agriculture and industry, heavy and light industries, big and small businesses, producers and consumers, management and labor; between different functional groups, such as city and country, the old, the middle-aged, and the young, the economic and the political sphere, the middle classes and the upper and lower classes.)

Two assumptions are at the foundation of all such equilibriums: first, that the elements to be balanced are necessary for society or have a right to exist, and second, that without a state of equilibrium among them one element will gain ascendancy over the others, encroach upon their interests and rights, and might ultimately destroy them. Consequently, it is the purpose of all such equilibriums to maintain the stability of the system without destroying the multiplicity of the elements composing it. If the goal were stability alone, it could be achieved by allowing one element to destroy or overwhelm the others and take their place. Since the goal is stability plus the

² Cf., for instance, the impressive analogy between the equilibrium in the human body and in society in Walter B. Cannon, *The Wisdom of the Body* (New York: W. W. Norton and Company, 1932), pp. 293, 294: "At the outset it is noteworthy that the body politic itself exhibits some indications of crude automatic stabilizing processes. In the previous chapter I expressed the postulate that a certain degree of constancy in a complex system is itself evidence that agencies are acting or are ready to act to maintain that constancy. And moreover, that when a system remains steady it does so because any tendency towards change is met by increased effectiveness of the factor or factors which resist the change. Many familiar facts prove that these statements are to some degree true for society even in its present unstabilized condition. A display of conservatism excites a radical revolt and that in turn is followed by a return to conservatism. Loose government and its consequences bring the reformers into power, but their tight reins soon provoke restiveness and the desire for release. The noble enthusiasms and sacrifices of war are succeeded by moral apathy and orgies of self-indulgence. Hardly any strong tendency in a nation continues to the stage of disaster; before that extreme is reached corrective forces arise which check the tendency and they commonly prevail to such an excessive degree as themselves to cause a reaction. A study of the nature of these social swings and their reversal might lead to valuable understanding and possibly to means of more narrowly limiting the disturbances. At this point, however, we merely note that the disturbances are roughly limited, and that this limitation suggests, perhaps, the early stages of social homeostasis." (Reprinted by permission of the publisher, Copyright 1932, 1939, by Walter B. Cannon.)

The Balance of Power

preservation of all the elements of the system, the equilibrium must aim at preventing any element from gaining ascendancy over the others. The means employed to maintain the equilibrium consist in allowing the different elements to pursue their opposing tendencies up to the point where the tendency of one is not so strong as to overcome the tendency of the others, but strong enough to prevent the others from overcoming its own.

Nowhere have the mechanics of social equilibrium been described more brilliantly and at the same time more simply than in *The Federalist*. Concerning the system of checks and balances of the American government, No. 51 of *The Federalist* says:

This policy of supplying, by opposite and rival interests, the defect of better motives, might be traced to the whole system of human affairs, private as well as public. We see it particularly displayed in all the subordinate distributions of power, where the constant aim is to divide and arrange the several offices in such a manner as that each may be a check on the other — that the private interests of every individual may be a sentinel over the public rights. These inventions of prudence cannot be less requisite in the distribution of the supreme powers of the state.

(The concept of equilibrium or balance has indeed found its most important application, outside the international field, in the sphere of domestic government and politics.⁸ Parliamentary bodies have frequently developed within themselves a balance of power. A multi-party system lends itself particularly to such a development.) Here two groups, each representing a minority of the legislative body, often oppose each other, and the formation of a majority depends upon the votes of a third group. The third group will tend to join the potentially or actually weaker of the two, thus imposing a check upon the stronger one. Even the two-party system of the United States

⁸ It hardly needs to be pointed out that, while the balance of power is a universal social phenomenon, its functions and results are different in domestic and international politics. The balance of power operates in domestic politics within a relatively stable framework of an integrated society, kept together by a strong consensus and the normally unchallengeable power of a central government. On the international scene, where consensus is weak and a central authority does not exist, the stability of society and the freedom of its component parts depend to a much greater extent upon the operations of the balance of power. More concerning this will be said below. Cf. Chapter XII.

Cf. also J. Allen Smith, *The Growth and Decadence of Constitutional Government* (New York: Henry Holt and Company, 1930), pp. 241, 242: "In the absence of any common and impartial agency to interpret international law and supervise international relations, every state is anxious not only to increase its own authority but to prevent, if possible, any increase in the authority of rival states. The instinct of self-preservation, in a world made up of independent nations, operates to make each desire power in order to secure itself against the danger of external aggression. The fact that no country alone is sufficiently strong to feel secure against any possible combination of opposing states makes necessary the formation of alliances and counter-alliances through which each state seeks to ensure the needed support in case its safety is menaced from without. This is usually referred to as the struggle to maintain the balance of power. It is merely an application of the check and balance theory of the state to international politics. It is assumed, and rightly so, that if any state should acquire a predominant position in international affairs, it would be a distinct menace to the interests and well-being of the rest of the world. Power, even though it may have been acquired as a means of protection, becomes a menace to international peace as soon as the country possessing it comes to feel stronger than any possible foe. It is no less necessary to maintain the balance of power in international politics, than it is to prevent some special interest from gaining the ascendancy in the state. But since this balance of power idea is based on the fear of attack and assumes that every nation should be prepared for war, it can not be regarded as in any real sense a guaranty of international peace." (Reprinted by permission of the publisher.)

Politics among Nations

Congress displayed the typical constellation of this checking and balancing process when, especially in the last years of the administration of Franklin D. Roosevelt, the Southern Democrats constituted themselves a third party, voting on many issues with the Republican minority. They thus checked not only the Democratic majority in Congress, but also the executive branch which, too, was controlled by the Democratic party.⁴

The American government is the outstanding modern example of a governmental system whose stability is maintained by an equilibrium among its component parts. Lord Bryce has said:

The Constitution was avowedly created as an instrument of checks and balances. Each branch of the government was to restrain the others, and maintain the equipoise of the whole. The legislature was to balance the executive, and the judiciary both. The two houses of the legislature were to balance one another. The national government, taking all its branches together, was balanced against the State governments. As the equilibrium was placed under the protection of a document, unchangeable save by the people themselves, no one of the branches of the national government has been able to absorb or override the others . . . each branch maintains its independence and can, within certain limits, defy the others.

But there is among political bodies and offices (i.e. the persons who from time to time fill the same office) of necessity a constant strife, a struggle for existence similar to that which Mr. Darwin has shown to exist among plants and animals; and as in the case of plants and animals so also in the political sphere this struggle stimulates each body or office to exert its utmost force for its own preservation, and to develop its aptitudes in any direction where development is possible. Each branch of the American government has striven to extend its range and its powers; each has advanced in certain directions, but in others has been restrained by the equal or stronger pressure of other branches.⁵

No. 51 of *The Federalist* has laid bare the power structure of this "dynamic equilibrium" or "moving parallelogram of force," as it was called by Charles A. Beard⁶ ". . . the defect must be supplied, by so contriving the interior structure of the government as that its several constitutional parts may, by their mutual relations, be the means of keeping each other in their proper places. . . . But the great security against a gradual concentration of the several powers in the same department, consists in giving to those who administer each department the necessary constitutional means and personal

⁴ Cf. the illuminating discussion of the general problem in John Stuart Mill, *Considerations on Representative Government* (New York: Henry Holt and Company, 1882), p. 142: "In a state of society thus composed, if the representative system could be made ideally perfect, and if it were possible to maintain it in that state, its organization must be such that these two classes, manual laborers and their affinities on one side, employers of labor and their affinities on the other, should be, in the arrangement of the representative system, equally balanced, each influencing about an equal number of votes in Parliament; since, assuming that the majority of each class, in any difference between them, would be mainly governed by their class interests, there would be a minority of each in whom that consideration would be subordinate to reason, justice, and the good of the whole; and this minority of either, joining with the whole of the other, would turn the scale against any demands of their own majority which were not such as ought to prevail." See also p. 143, and, concerning the balance of power within federal states, pp. 321-2.

⁵ *The American Commonwealth* (New York: The Macmillan Company, 1891), I, 390-1.

⁶ *The Republic* (New York: The Viking Press, 1944), pp. 190-1.

The Balance of Power

motives to resist the encroachment of others. . . . The provision for defense must in this, as in all other cases, be made commensurate to the danger of attack. Ambition must be made to counteract ambition. The interest of the man must be connected with the constitutional rights of the place. . . ." The aim of these constitutional arrangements is "to guard one part of the society against the injustices of the other part. Different interests necessarily exist in different classes of citizens. If a majority be reunited by a common interest, the rights of the minority will be insecure."

The author, Hamilton or Madison, expected to safeguard the rights of the minority "by comprehending in the society so many separate descriptions of citizens as will render an unjust combination of a majority of the whole very improbable, if not impracticable. . . . The society itself will be broken into so many parts, interests, and classes of citizens, that the rights of individuals, or of the minority, will be in little danger from interested combinations of the majority." Security will lie "in the multiplicity of interests," and the degree of security "will depend on the number of interests." And Charles A. Beard thus summarizes the philosophy of the American government: "The framers understood that government in action is power. They tried to pit the ambitions, interests, and forces of human beings in the three departments against one another in such a way as to prevent any one set of agents from seizing all power, from becoming dangerously powerful."⁷

One needs only to substitute the terminology of international politics for the concepts used by *The Federalist*, Lord Bryce, and Professor Beard in their analysis of the structure and dynamics of the American government, and there emerge the main elements common to both the system of checks and balances of the American Constitution and the international balance of power. In other words, the same motive forces have given rise to the American system of checks and balances and to the international system of the balance of power. Both systems seek to fulfill the same functions for their own stability and the autonomy of their constituent elements, however much they may differ in the means which they employ and in the degree to which they realize their aim. Both are subject to the same dynamic processes of change, disequilibrium, and the establishment of a new balance on a different level.

Which are the main patterns of the international balance of power? What are the typical situations out of which it arises and within which it operates? What functions does it fulfill? And to what transformations has it been subjected in recent history?

2. TWO MAIN PATTERNS OF THE BALANCE OF POWER

Two factors are at the basis of international society: one is the multiplicity, the other is the antagonism of its elements, the individual nations. The

⁷ *Ibid.*

Politics among Nations

aspirations for power of the individual nations can come into conflict with each other — and some, if not most of them, do at any particular moment in history — in two different ways. In other words, the struggle for power on the international scene can be fought in two typical patterns.)

Nation A may embark upon an imperialistic policy with regard to nation B, and nation B may counter that policy with a policy of the status quo or with an imperialistic policy of its own. France and its allies opposing Russia in 1812, Japan opposing China from 1931 to 1941, the United Nations vs. the Axis from 1941 on correspond to that pattern. The pattern is one of direct opposition between the nation which wants to establish its power over another nation, and the latter which refuses to yield.

(Nation A may also pursue an imperialistic policy toward nation C, which may either resist or acquiesce in that policy, while nation B follows with regard to nation C either a policy of imperialism or one of the status quo. In this case, the domination of C is a goal of A's policy. B, on the other hand, is opposed to A's policy because it either wants to preserve the status quo with respect to C or wants the domination of C for itself. The pattern of the struggle for power between A and B is here not one of direct opposition, but of competition, the object of which is the domination of C, and it is only through the intermediary of that competition that the contest for power between A and B takes place. This pattern is visible, for instance, in the competition between Great Britain and Russia for the domination of Iran in which the struggle for power between the two countries has repeatedly manifested itself during the last hundred years. It is also clear in the competition for the domination of Germany which during the aftermath of the Second World War has marked the relations between France, Great Britain, the Soviet Union, and the United States. The competition between the United States and the Soviet Union for the domination of Turkey offers another example of the same pattern.)

It is in situations such as these that the balance of power operates and fulfills its typical functions. In the pattern of direct opposition, the balance of power is the direct result of the desire of either nation to see its policies prevail over the policies of the other. A tries to increase its power in relation to B to such an extent that it can control the decisions of B and thus lead its imperialistic policy to success. B, on the other hand, will try to increase its power to such an extent that it can resist A's pressure and thus frustrate A's policy, or else embark upon an imperialistic policy of its own with a chance for success. In the latter case, A, in turn, must increase its power in order to be able both to resist B's imperialistic policy and to pursue its own with a chance for success. This balancing of opposing forces will go on, the increase in the power of one nation calling forth an at least proportionate increase in the power of the other nation, until the nations concerned change the objectives of their imperialistic policies, if they do not give them up altogether, or until one nation gains or believes it has gained a decisive advantage over the other nation. In that event, either the weaker yields to the stronger or the contest of war decides the issue.

So long as the balance of power operates successfully in such a situation,

The Balance of Power

it fulfills two functions. It creates a precarious stability in the relations between the respective nations, a stability which is always in danger of being disturbed and, therefore, is always in need of being re-established. This is, however, the only stability obtainable under the assumed conditions of the power pattern. For we are here in the presence of an inevitable inner contradiction of the balance of power. One of the two functions the balance of power is supposed to fulfill is stability in the power relations among nations; yet these relations are, as we have seen, by their very nature subject to continuous change. They are essentially unstable. Since the weights which determine the relative position of the scales have a tendency to change continuously by growing either heavier or lighter, whatever stability the balance of power may achieve must be precarious and subject to perpetual adjustments in conformity with intervening changes. The other function which a successful balance of power fulfills under these conditions is to insure the freedom of one nation from domination by the other.

Owing to the essentially unstable and dynamic character of the balance, which is not unstable and dynamic by accident or only part of the time, but by nature and always, the independence of the nations concerned is also essentially precarious and in danger. Here again, however, it must be said that, given the conditions of the power pattern, the independence of the respective nations can rest on no other foundation than the power of each individual nation to prevent the power of the other nations from encroaching upon its freedom. The following diagram illustrates this situation:

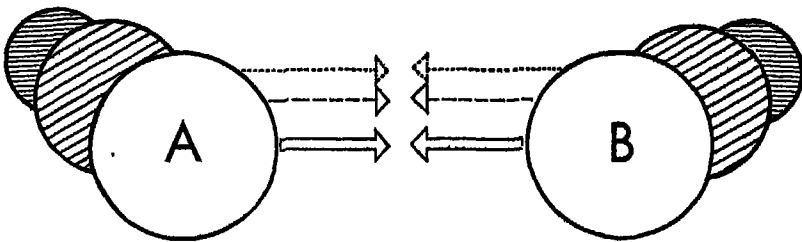

In the other pattern, the pattern of competition, the mechanics of the balance of power are identical with those discussed. The power of A necessary to dominate C in the face of B's opposition is balanced, if not outweighed, by B's power, while, in turn, B's power to gain dominion over C is balanced, if not outweighed, by the power of A. The additional function, however, which the balance here fulfills, aside from creating a precarious stability and security in the relations between A and B, consists in safeguarding the independence of C against encroachments by A or B. The independence of C is a mere function of the power relations existing between A and B. •

Politics among Nations

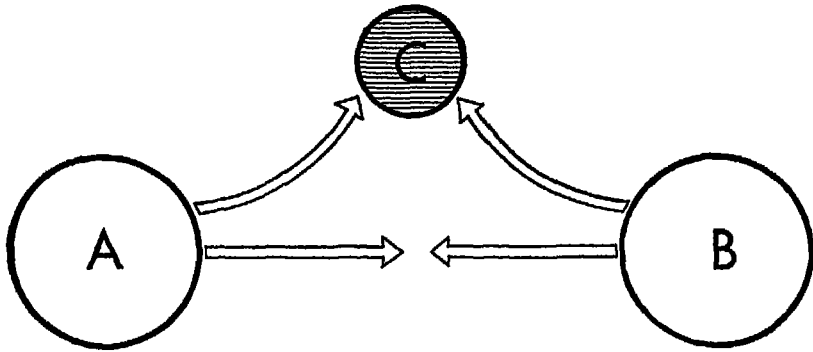

If these relations take a decisive turn in favor of the imperialistic nation, that is, A, the independence of C will at once be in jeopardy.

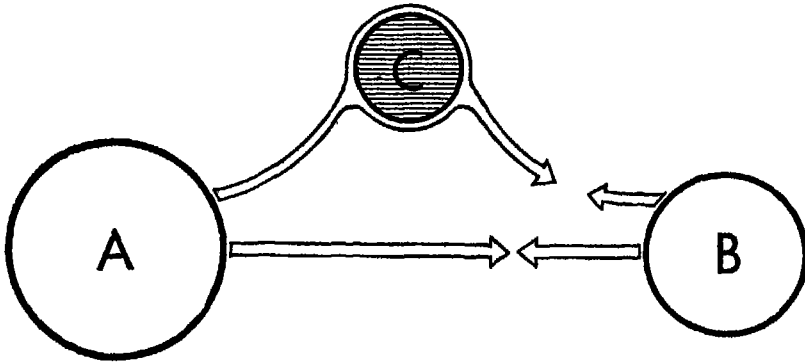

If the status quo nation, that is, B, should gain a decisive and permanent advantage, C's freedom will be more secure in the measure of that advantage.

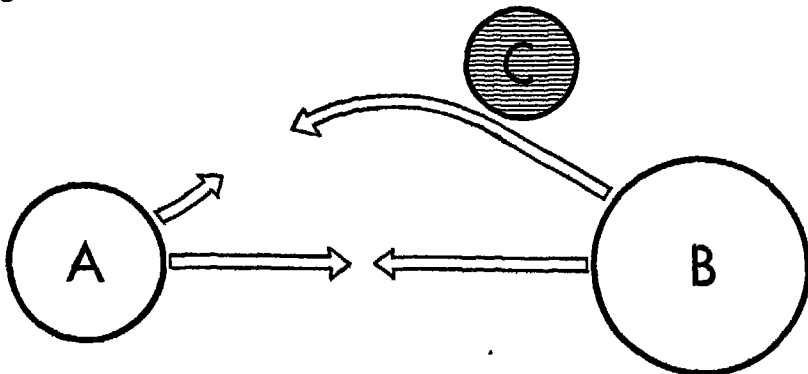

If, finally, the imperialistic nation A should give up its imperialistic policies altogether or shift them permanently from C to another objective, that is, D, the freedom of C would be permanently secured.

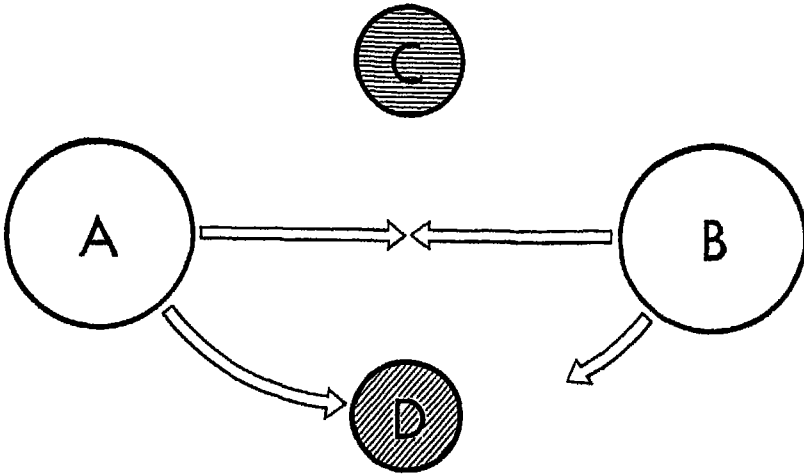

Nowhere has this function of the balance of power to preserve the independence of weak nations been more clearly recognized than by Edmund Burke, the greatest depository of political wisdom in the English language. He said in 1791 in his *Thoughts on French Affairs*:

As long as those two princes (the King of Prussia and the German Emperor), are at variance, so long the liberties of Germany are safe. But if ever they should so far understand one another as to be persuaded that they have a more direct and more certainly defined interest in a proportioned mutual aggrandizement than in a reciprocal reduction, that is, if they come to think that they are more likely to be enriched by a division of spoil than to be rendered secure by keeping to the old policy of preventing others from being spoiled by either of them, from that moment the liberties of Germany are no more.⁸

Small nations have always owed their independence either to the balance of power (Belgium and the Balkan countries until the Second World War), or to the preponderance of one protecting power (the small nations of Central and South America and Portugal), or to their lack of attractiveness for imperialistic aspirations (Switzerland and Spain). The ability of such small nations to maintain their neutrality while war rages around them has always been due to one or the other or all of these factors. The Netherlands, Denmark, and Norway in the First, in contrast to the Second World War, and Switzerland and Sweden in both world wars are cases in point.

The same factors are responsible for the existence of so-called buffer states — weak states located close to powerful ones and serving their military security. The outstanding example of a buffer state owing its existence to the balance of power is Belgium from the beginning of its history as an independent state in 1831 to the Second World War. The nations belonging to the so-called Russian security belt which stretches along the western and southwestern frontiers of the Soviet Union from Finland to Bulgaria exist by leave of their preponderant neighbor whose military interests they serve.

⁸ *Works* (Boston: Little, Brown, and Company, 1889), IV, 337.

CHAPTER X

Different Methods of the Balance of Power

The balancing process can be carried on either by diminishing the weight of the heavier scale or by increasing the weight of the lighter one.

✓ DIVIDE AND RULE

The former method has found its classical manifestation, aside from the imposition of onerous conditions in peace treaties and the incitement to treason and revolution, in the maxim "divide and rule." It has been resorted to by nations who tried to make or keep their competitors weak by dividing them or keeping them divided. The most consistent and important policies of this kind in modern times are the policy of France with respect to Germany and the policy of the Soviet Union with respect to the rest of Europe. From the seventeenth century to the present day, it has been an unvarying principle of French foreign policy either to favor the division of the German Empire into a number of small independent states or to prevent the coalescence of such states into one unified nation. The support of the Protestant princes of Germany by Richelieu, of the Rhinebund by Napoleon I, of the princes of Southern Germany by Napoleon III, of the abortive separatist movements after the First World War, and the opposition to the unification of Germany after the Second World War — all have their common denominator in considerations of the balance of power in Europe which France found threatened by a strong German state. Similarly, the Soviet Union from the twenties to the present has consistently opposed all plans for the unification of Europe, on the assumption that the pooling of the divided strength of the European nations into a "Western bloc" would give the enemies of the Soviet Union such power as to threaten the latter's security.

The other method of balancing the power of several nations consists in adding to the strength of the weaker nation. This method can be carried out by two different means: Either B can increase its power sufficiently to offset,

Different Methods of the Balance of Power

if not surpass, the power of A, and vice versa. Or B can pool its power with the power of all the other nations which pursue identical policies with regard to A, in which case A will pool its power with all the nations pursuing identical policies with respect to B. The former alternative is exemplified by the policy of compensations and the armament race as well as by disarmament; the latter, by the policy of alliances.

2. COMPENSATIONS

Compensations of a territorial nature were in the eighteenth and nineteenth centuries a common device for maintaining a balance of power which had been, or was to be, disturbed by the territorial acquisitions of one nation. The Treaty of Utrecht of 1713 which terminated the War of the Spanish Succession recognized for the first time expressly the principle of the balance of power by way of territorial compensations. It provided for the division of most of the Spanish possessions, European and colonial, between the Hapsburgs and the Bourbons) "*ad conservandum in Europa equilibrium,*" as the treaty put it.

(The three partitions of Poland in 1772, 1793, and 1795, which in a sense mark the end of the classic period of the balance of power for reasons we will discuss later,¹ reaffirm its essence by proceeding under the guidance of the principle of compensations. Since territorial acquisitions at the expense of Poland by any one of the interested nations, Austria, Prussia, and Russia, to the exclusion of the others would have upset the balance of power, the three nations agreed to divide Polish territory in such a way that the distribution of power among themselves would be approximately the same after the partitions as it had been before. In the treaty of 1772 between Austria and Russia, it was even stipulated that "the acquisitions . . . shall be completely equal, the portion of one cannot exceed the portion of the other."

Fertility of the soil and number and quality of the populations concerned were used as objective standards by which to determine the increase in power which the individual nations received through the acquisition of territory. While in the eighteenth century this standard was rather crudely applied, the Congress of Vienna refined the policy of compensations by appointing in 1815 a statistical commission which was charged with evaluating the territories to be disposed of by the standard of number, quality, and type of population.

In the latter part of the nineteenth and the beginning of the twentieth century, the principle of compensations was again consciously applied to the distribution of colonial territories and the delimitation of colonial or semi-colonial spheres of influence. Africa, in particular, was during that period the object of numerous treaties delimiting spheres of influence for the major colonial powers. Thus the competition between France, Great Britain, and Italy for the domination of Ethiopia was provisionally resolved, after the model of the partitions of Poland, by the treaty of 1906 which divided the country into three spheres of influence for the purpose of establishing in that

¹ See below, p. 150.

Politics among Nations

region a balance of power among the nations concerned. Similarly, the rivalry between Great Britain and Russia with respect to Iran led to the Anglo-Russian treaty of 1907 which established spheres of influence for the contracting parties and a neutral sphere under the exclusive domination of Iran. The compensation consists here not in the outright cession of territorial sovereignty, but rather in the reservation, to the exclusive benefit of a particular nation, of certain territories for commercial exploitation, political and military penetration, and eventual establishment of sovereignty. In other words, the particular nation has the right, without having full title to the territory concerned, to operate within its sphere of influence without competition or opposition from any other nation. The other nation, in turn, has the right to claim for its own sphere of influence the same abstinence on the part of the former.

Even where the principle of compensations is not consciously applied, however, as it was in the aforementioned treaties, it is nowhere absent from political arrangements, territorial or other, made within a balance-of-power system. For given such a system, no nation will agree to concede political advantages to another nation without the expectation, which may or may not be well founded, of receiving proportionate advantages in return. The bargaining of diplomatic negotiations, issuing in political compromise, is but the principle of compensations in its most general form and as such it is organically connected with the balance of power.

3. ARMAMENTS

The principal means, however, by which a nation endeavors with the power at its disposal to maintain or re-establish the balance of power are armaments. The armament race in which nation A tries to keep up with, and then to outdo, the armaments of nation B, and vice versa, is the typical instrumentality of an unstable, dynamic balance of power. The necessary corollary of the armaments race is a constantly increasing burden of military preparations devouring an ever greater portion of the national budget and making for ever deepening fears, suspicions, and insecurity. The situation preceding the First World War with the naval competition between Germany and Great Britain and the rivalry of the French and German armies illustrates this point.

It is in recognition of situations such as these that since the end of the Napoleonic Wars repeated attempts have been made to create a stable balance of power, if not to establish permanent peace, by means of proportionate disarmament of competing nations. The technique of stabilizing the balance of power by means of a proportionate reduction of armaments is somewhat similar to the technique of territorial compensations. For this technique, too, requires a quantitative evaluation of the changes which disarmament will bring about in the respective power of the individual nations. The difficulties in making such a quantitative evaluation, in correlating, for instance, the military strength of the French Army of 1932 with the military power represented by the industrial potential of Germany, have greatly

Different Methods of the Balance of Power

contributed to the failure of most attempts at creating a stable balance of power by means of disarmament. The only outstanding success of this kind was the Washington Naval Treaty of 1922 in which Great Britain, the United States, Japan, France, and Italy agreed to a proportionate reduction and limitation of naval armaments. Yet it must be noted that this treaty was part of an overall political and territorial settlement in the Pacific which sought to stabilize the power relations in that region on the foundation of Anglo-American predominance. (The problem of disarmament will be discussed in greater detail in Chapter XXI.)

4. ALLIANCES

The historically most important manifestation of the balance of power, however, is to be found, not in the equilibrium of two isolated nations, but in the relations between one nation or alliance of nations and another alliance.

a) Alliances vs. World Domination

While the balance of power as a natural and inevitable outgrowth of the struggle for power is as old as political history itself, systematic theoretic reflections, starting in the sixteenth century and reaching their culmination in the eighteenth and nineteenth centuries, have conceived the balance of power generally as a protective device of an alliance of nations, anxious for their independence, against another nation's designs for world domination, then called universal monarchy.

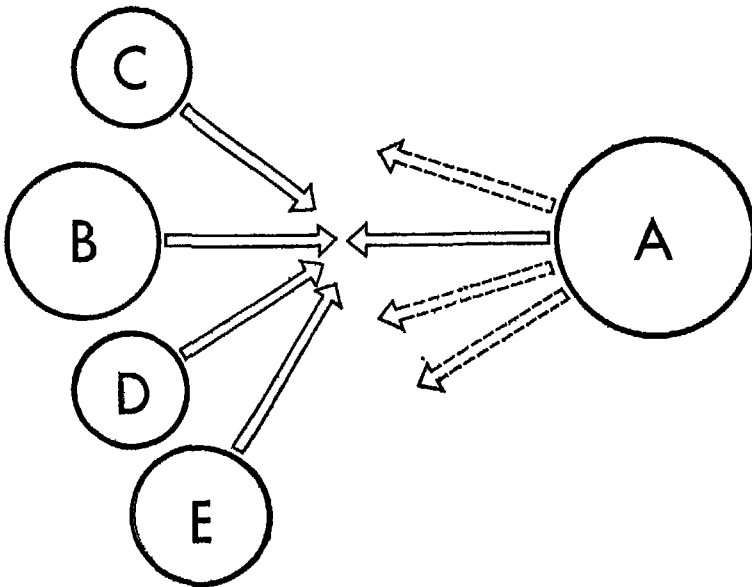

Politics among Nations

Francis Bacon was, after the Florentine statesmen and historians Rucellai and Guicciardini, the first to recognize the essence of the balance of power by way of alliances. In his essay *Of Empire* he says:

First, for their neighbors, there can no general rule be given (the occasions are so variable), save one which ever holdeth — which is, that princes do keep due sentinel, that none of their neighbors do overgrow so (by increase of territory, by embracing of trade, by approaches, or the like,) as they become more able to annoy them than they were. . . . During that triumvirate of kings, King Henry VIII of England, Francis I, king of France, and Charles V, emperor, there was such a watch kept that none of the three could win a palm of ground, but the other two would straightways balance it, either by confederation, or, if need were, by a war, and would not in any wise take up peace at interest; and the like was done by that League (which Guicciardine saith was the security of Italy,) made between Ferdinando, king of Naples, Lorenzsius Medices, and Ludovicus Sforza, potentates, the one of Florence, the other of Milan.

The alliances which Francis I concluded with Henry VIII and the Turks in order to prevent Charles V of Hapsburg from stabilizing and expanding his empire are the first modern example on a grand scale of the balance of power operating between an alliance and one nation intent upon establishing a universal monarchy. In the second half of the seventeenth century, Louis XIV of France took over the role which the Hapsburgs had played before and called forth a similar reaction among the European nations. Alliances were formed around England and the Netherlands with the purpose of protecting the European nations from French domination and establishing a new balance of power between France and the rest of Europe.

The wars against the France of 1789 and against Napoleon show the same constellation of one preponderant nation aiming at world domination and being opposed by a coalition of nations for the sake of preserving their independence. The manifesto with which the first coalition initiated these wars in 1792 declared that "no power interested in the maintenance of the balance of power in Europe could see with indifference the Kingdom of France, which at one time formed so important a weight in this great balance, delivered any longer to domestic agitations and to the horrors of disorder and anarchy which, so to speak, have destroyed her political existence." And when these wars reached their conclusion, it was still the intention of the Allied powers, in the words of the Convention of Paris of April 23, 1814, "to put an end to the miseries of Europe, and to found her repose upon a just redistribution of forces among the nations of which she is composed," that is, upon a new balance of power. The coalitions which fought the Second World War against Germany and Japan owed their existence to the same fear, common to all their members, of the latter nations' imperialism, and they pursued the same goal of preserving their independence in a new balance of power.

b) Alliances vs. Counteralliances

The struggle between an alliance of nations defending their independence against one potential conqueror is the most spectacular of the constellations to which the balance of power gives rise. The opposition of two alliances, one

Different Methods of the Balance of Power

or both pursuing imperialistic goals and defending the independence of their members against the imperialistic aspirations of the other coalition, is the most frequent constellation within the system of the balance of power.

To mention only a few of the more important examples, the coalitions which fought the Thirty Years' War under the leadership of France and Sweden, on the one hand, and of Austria, on the other, sought to promote the imperialistic ambitions especially of Sweden and Austria and at the same time to keep these ambitions in check. The several treaties settling the affairs of Europe after the Thirty Years' War tried to establish a balance of power serving the latter end. The many coalition wars, which filled the period between the Treaty of Utrecht of 1713 and the first partition of Poland of 1772, all attempted to maintain the balance which the Treaty of Utrecht had established and which the decline of Swedish power as well as the rise of Prussian, Russian, and British strength tended to disturb. The frequent changes in the alignments, even while war was in progress, have startled the historians and have made the eighteenth century appear to be particularly unprincipled and devoid of moral considerations. It was against that kind of foreign policy that Washington's Farewell Address warned the American people.

Yet the period in which that foreign policy flourished was the golden age of the balance of power in theory as well as in practice. It was during that period that most of the literature of the balance of power was published and that the princes of Europe looked to the balance of power as the supreme principle to guide their conduct in foreign affairs. It is true that they allowed themselves to be guided by it in order to further their own interests. But, by doing so, it was inevitable that they would change sides, desert old alliances, and form new ones whenever it seemed to them that the balance of power had been disturbed and that a realignment of forces was needed to re-establish it. In that period, foreign policy was indeed a sport of kings, not to be taken more seriously than games and gambles, played for strictly limited stakes, and utterly devoid of transcendent principles of any kind.

Since such was the nature of international politics, what looks in retrospect like treachery and immorality was then little more than an elegant maneuver, a daring piece of strategy, or a finely contrived tactical movement, all executed according to the rules of the game which all players recognized as binding. The balance of power of that period was amoral rather than immoral. The technical rules of the art of politics were its only standard. Its flexibility, which was its peculiar merit from the technical point of view, was, then, the result of imperviousness to moral considerations, such as good faith and loyalty, a moral deficiency which to us seems deserving of reproach.

From the beginning of the modern state system at the turn of the fifteenth century to the end of the Napoleonic Wars in 1815, European nations were the active factors in the balance of power. Turkey was the one notable exception. Alliances and counteralliances were formed in order to maintain the balance or to re-establish it. The century from 1815 to the outbreak of the First World War saw the gradual extension of the European balance of power into a world-wide system. One might say that this epoch started with President Monroe's message to Congress in 1823, containing what is known as the Monroe Doctrine. By declaring the mutual political independence of Europe

Politics among Nations

and the Western Hemisphere and thus dividing the world, as it were, into two political systems, President Monroe laid the groundwork for the subsequent transformation of the European into a world-wide balance-of-power system.

This transformation was for the first time clearly envisaged and formulated in the speech which George Canning made as British Foreign Secretary to the House of Commons on December 12, 1826. Canning had been criticized for not having gone to war with France in order to restore the balance of power which had been disturbed by the French invasion of Spain. In order to disarm his critics, he formulated a new theory of the balance of power. Through the instrumentality of British recognition of their independence he included the newly freed Latin-American republics as active elements in the balance. He reasoned thus:

But were there no other means than war for restoring the balance of power? — Is the balance of power a fixed and unalterable standard? Or is it not a standard perpetually varying, as civilization advances, and as new nations spring up, and take their place among established political communities? The balance of power a century and a half ago was to be adjusted between France and Spain, the Netherlands, Austria, and England. Some years after, Russia assumed her high station in European politics. Some years after that again, Prussia became not only a substantive, but a preponderating monarchy. — Thus, while the balance of power continued in principle the same, the means of adjusting it became more varied and enlarged. They became enlarged, in proportion to the increased number of considerable states — in proportion, I may say, to the number of weights which might be shifted into the one or the other scale. . . . Was there no other mode of resistance, than by a direct attack upon France — or by a war to be undertaken on the soil of Spain? What, if the possession of Spain might be rendered harmless in rival hands — harmless as regarded us — and valueless to the possessors? Might not compensation for disparagement be obtained . . . by means better adapted to the present time? If France occupied Spain, was it necessary, in order to avoid the consequences of that occupation — that we should blockade Cadiz? No. I looked another way — I saw materials for compensation in another hemisphere. Contemplating Spain, such as our ancestors had known her, I resolved that if France had Spain, it should not be Spain "*with the Indies.*" I called the New World into existence, to redress the balance of the Old.²

This development toward a world-wide balance of power operating by means of alliances and counteralliances was consummated in the course of the First World War in which practically all nations of the world participated actively on one or the other side. The very designation of that war as a "world" war points to the consummation of the development.

In contrast to the Second World War, however, the First World War had its origins exclusively in the fear of a disturbance of the European balance of power which was threatened in two regions: Belgium and the Balkans. Belgium, located at the northeastern frontier of France and guarding the eastern approaches to the English Channel, found itself a focal point of great power

² *Speeches of the Right Honourable George Canning* (London, 1836), VI, 109-11.

Different Methods of the Balance of Power

competition, without being strong enough to participate actively in that competition. That the independence of Belgium was necessary for the balance of power in Europe was axiomatic. Its annexation by any of the great European nations would of necessity make that nation too powerful for the security of the others. This was recognized from the very moment when Belgium gained its independence with the active support of Great Britain, Austria, Russia, Prussia, and France. These nations, assembled at a conference in London, declared on February 19, 1831, that "They had the right, and the events imposed upon them the duty to see to it that the Belgian provinces, after they had become independent, did not jeopardize the general security and the European balance of power."³

In furtherance of that aim, the five nations concerned concluded in 1839 a treaty in which they declared Belgium to be "an independent and perpetually neutral state" under the collective guaranty of the five signatories. This declaration sought to prevent Belgium forever from participating, on one or the other side, in the European balance of power. It was the German violation of Belgium's neutrality which in 1914 crystallized the threat to the balance of power emanating from Germany and enabled Great Britain to justify its participation in the war on the side of France, Russia, and their allies.

The concern of Austria, Great Britain, and Russia in the preservation of the balance of power in the Balkans was concomitant with the weakening of Turkish power in that region. The Crimean War of 1854-56 was fought by an alliance of France, Great Britain, and Turkey against Russia for the purpose of maintaining the balance of power in the Balkans. The alliance treaty of March 13, 1854, declared "that the existence of the Ottoman Empire in its present extent, is of essential importance to the balance of power among the states of Europe." The subsequent rivalries and wars, especially the events which led to the Congress of Berlin of 1878 and the Balkan wars of 1912 and 1913, are all overshadowed by the fear that one of the nations mainly interested in the Balkans might gain an increase in power in that region out of proportion to the power of the other nations concerned.

In the years immediately preceding the First World War, the balance of power in the Balkans increased in importance; for, since the Triple Alliance between Austria, Germany, and Italy seemed approximately to balance the Triple Entente between France, Russia, and Great Britain, the power combination which gained a decisive advantage in the Balkans might easily gain a decisive advantage in the over-all European balance of power. It was that fear which motivated Austria in July 1914 to try to settle its accounts with Serbia once and for all and which induced Germany to support Austria unconditionally. It was the same fear which brought Russia to the support of Serbia, and France to the support of Russia. In his telegraphic message of August 2, 1914, to George V of England, the Russian Czar summed the situation up well when he said that the effect of the predominance of Austria over Serbia "would have been to upset balance of power in Balkans, which is of such vital interest to my Empire as well as to those Powers who desire

³ *Protocols of Conferences in London Relative to the Affairs of Belgium (1830-31)*, p. 60.

Politics among Nations

maintenance of balance of power in Europe . . . I trust your country will not fail to support France and Russia in fighting to maintain balance of power in Europe."⁴

After the First World War, France maintained permanent alliances with Poland, Czechoslovakia, Yugoslavia, and Rumania and, in 1935, concluded an alliance — which was, however, not implemented — with the Soviet Union. This policy can be understood as a kind of preventive balance-of-power policy which anticipated Germany's comeback and attempted to maintain the status quo of Versailles in the face of such an eventuality. On the other hand, the formation in 1936 of an alliance between Germany, Italy, and Japan, called the Axis, was intended as a counterweight against the alliance between France and the Eastern European nations, which would at the same time neutralize the Soviet Union.

Thus the period between the two world wars stands in fact under the sign of the balance of power by alliances and counteralliances, although in theory the principle of the balance of power was supposed to have been superseded by the League-of-Nations principle of collective security. Yet, actually, collective security, as shall be shown later in greater detail,⁵ did not abolish the balance of power. Rather it reaffirmed it in form of a universal alliance against any potential aggressor, the presumption being that such an alliance would always outweigh any potential aggressor. Collective security differs, however, from the balance of power in the principle of association by virtue of which the alliance is formed. Balance-of-power alliances are formed by certain individual nations against other individual nations or an alliance of them on the basis of what those individual nations regard as their separate national interests. The organizing principle of collective security is the respect for the moral and legal obligation to consider an attack by any nation upon any member of the alliance as an attack upon all members of the alliance. Consequently, collective security operates automatically, that is, aggression calls the counteralliance into operation at once and, therefore, protects peace and security with the greatest possible efficiency. Alliances within a balance-of-power system, on the other hand, are frequently uncertain in actual operation since they are dependent upon political considerations of the individual nations. The defection of Italy from the Triple Alliance in 1915 and the disintegration of the French system of alliances between 1935 and 1939 illustrate this weakness of the balance of power.

5. THE "HOLDER" OF THE BALANCE

Whenever the balance of power is to be realized by means of an alliance — and this has been generally so up to the end of the Second World War — two possible variations of this pattern have to be distinguished. To use the language of the metaphor of the balance, the system may consist of two scales in each of which are to be found the nation or nations identified with the

⁴ *British Documents on the Origins of the War, 1898-1914* (London: His Majesty's Stationery Office, 1926), XI, 276.

⁵ See below, Chapter XXII.

Different Methods of the Balance of Power

same policy of the status quo or of imperialism. The continental nations of Europe have generally operated the balance of power in this way.

The system may, however, consist of two scales plus a third element, the "holder" of the balance or the "balancer." The balancer is not permanently identified with the policies of either nation or group of nations. Its only objective within the system is the maintenance of the balance, regardless of the concrete policies which the balance will serve. In consequence, the holder of the balance will throw its weight at one time in this scale, at another time in the other scale, guided only by one consideration, that is, the relative position of the scales. Thus it will put its weight always in the scale which seems to be higher than the other because it is lighter. The balancer may become in a relatively short span of history consecutively the friend and foe of all major powers, provided they all consecutively threaten the balance by approaching predominance over the others and are in turn threatened by others which are about to gain such predominance. While the holder of the balance has no permanent friends, it has no permanent foes either.

The balancer is in a position of "splendid isolation." It is isolated by its own choice; for, while the two scales of the balance must vie with each other to add its weight to theirs in order to gain the overweight necessary for success, it must refuse to enter into permanent ties with either side. The holder of the balance waits in the middle in watchful detachment to see which scale is likely to sink. Its isolation is "splendid"; for, since its support or lack of support is the decisive factor in the struggle for power, its foreign policy, if cleverly managed, is able to extract the highest price from those whom it supports. Since, however, this support, regardless of the price paid for it, is always uncertain and shifts from one side to the other in accordance with the movements of the balance, its policies are resented and subject to condemnation on moral grounds. Thus it has been said of the outstanding balancer in modern times, Great Britain, that it lets others fight its wars, that it keeps Europe divided in order to dominate the continent, and that the fickleness of its policies is such as to make alliances with Great Britain impossible. "Perfidious Albion" has become a by-word in the mouths of those who either were unable to gain Great Britain's support, however hard they tried, or else lost it after they had paid what seemed to them too high a price.

The holder of the balance occupies the key position in the system of the balance of power, since its position determines the outcome of the struggle for power. It has, therefore, been called the "arbiter" of the system who decides who will win and who will lose. By making it impossible for any nation or combination of nations to gain predominance over the others, it preserves its own independence as well as the independence of all the other nations, and is thus a most powerful factor in international politics.

The holder of the balance can use this power in three different ways. It can make its joining one or the other nation or alliance dependent upon certain conditions favorable to the maintenance or restoration of the balance. It can make its support of the peace settlement dependent upon similar conditions. It can, finally, in either situation see to it that the objectives of its own national policy, apart from the maintenance of the balance of power, are realized in the process of balancing the power of others.

Politics among Nations

France under Louis XIV and Italy in the decade before the First World War attempted to play this role of arbiter of the European balance of power. But France was too deeply involved in the struggle for power on the European continent, too much a part of its balance of power, and too much lacking in commanding superiority to play that role successfully. Italy, on the other hand, had not enough weight to throw around to give it the key position in the balance of power. For this reason it earned only the moral condemnation, but not the respect, which similar policies had brought Great Britain. Only Venice in the sixteenth century and Great Britain since the reign of Henry VIII were able to make the holding of the balance between other nations one of the cornerstones of their foreign policies, using the three methods mentioned above either severally or jointly.

The idea appeared for the first time with reference to the Venetians in a letter written in 1553 by Queen Mary of Hungary to the imperial ambassador in England. She pointed out that the Italians had good reason to oppose France; but, she continued, "You know how they fear the power of the one and of the other of the two princes [Charles V and Francis I] and how they are concerned to balance their power."⁶ In the following years, on the occasion of Venice's refusals of French offers of alliance, French statesmen characterized the foreign policy of Venice in similar terms, with special reference to the aspects of isolation and detachment from alliances with either side. In 1554, for instance, Henry II of France was reported by a Venetian ambassador to have explained such refusals by the fear of Venice that in the event of the death of Charles V Spain might become inferior to France; Venice, however, tried to "keep things in balance (*tener le cose in eguale stato*)."⁷ Another Venetian ambassador reported in 1558 that the French explained the foreign policy of Venice by its suspicion of the increase in power of France and Spain. Venice wanted to prevent "that the balance tip to either side (*che la bilancia non pendesse da alcuna parte*)."⁸ The ambassador added that "this policy is being praised and even admired by intelligent people; in these turbulent times the weak find protection nowhere but in the Republic of Venice and therefore all Italians, in particular, desire her independence and welcome her armaments."⁷

The classic example of the balancer has, however, been provided by Great Britain. To Henry VIII is attributed the maxim: *cui adhaereo praeest*, that is, "he whom I support will prevail." He is reported to have had himself painted holding in his right hand a pair of scales in perfect balance, one of them occupied by France, the other by Austria, and holding in his left hand a weight ready to be dropped in either scale. Of England under Elizabeth it was said "that France and Spain are as it were the Scales in the Balance of Europe and England the Tongue or the Holder of the Balance."⁸ In 1624, a French pamphlet invited King Jacob to follow the glorious example of Elizabeth and Henry VIII "who played his role so well between the Emperor

⁶ *Papiers d'État du Cardinal de Granvelle* (Paris, 1843), IV, 121.

⁷ Eugenio Albèri, *Le Relazioni degli Ambasciatori Veneti al Senato*, Series I (Firenze, 1862), II, 287, 464.

⁸ William Camden, *Annales of the History of the Most Renowned and Victorious Princess Elizabeth, Late Queen of England* (London, 1635), p. 196.

Different Methods of the Balance of Power

Charles V and King Francis by making himself feared and flattered by both and by holding, as it were, the balance between them."

With the appearance of Louis XIV as a new aspirant for the universal monarchy, it became more and more common, in England and elsewhere, to consider it the English mission to act as "arbiter of Europe" by keeping the Hapsburgs and France in balance. This same standard was applied critically to the foreign policy of Charles II, who made common cause with Louis XIV against the Netherlands, and in support of the anti-French policies of William III. With the War of the Spanish Succession, that standard was erected into a dogma, especially in England. It remained, as applied to ever new combinations of powers, practically unchallenged until the Manchester liberals after the middle of the nineteenth century advocated complete and permanent detachment from the affairs of the European continent, that is, isolationism, as the principle of British foreign policy. As the tradition and practice of British diplomacy, this variety of the balance of power seems to have disappeared only in recent years with the decline of British, and the growth of American and Russian, power.⁹

⁹ On this point, cf. the detailed discussion below, pp. 273 ff.

CHAPTER XI

The Structure of the Balance of Power

I. DOMINANT AND DEPENDENT SYSTEMS

We have spoken thus far of the balance of power as if it were one single system comprehending all nations actively engaged in international politics. Closer observation, however, reveals that such a system is frequently composed of a number of subsystems which are interrelated with each other, but which maintain within themselves a balance of power of their own. The interrelationship between the different systems is generally one of subordination in the sense that one dominates because of the relatively great weight accumulated in its scales, while the others are, as it were, attached to the scales of that dominant system.

Thus, in the sixteenth century, the dominant balance of power operated between France and the Hapsburgs, while at the same time an autonomous system kept the Italian states in equilibrium. In the latter part of the seventeenth century a separate balance of power developed in Northern Europe out of the challenge with which the rise of Swedish power confronted the nations adjacent to the Baltic Sea. The transformation of Prussia into a first-rate power in the eighteenth century brought about a particular German balance of power, the other scale of which had Austria as its main weight. This autonomous system, "a little Europe within the great," was dissolved only in 1866 with the expulsion of Austria from the Germanic Confederation as a consequence of the Prusso-Austrian War of the same year. The eighteenth century saw also the development of an Eastern balance of power occasioned by the ascendancy of Russia. The partitions of Poland, by virtue of the principle of compensations, between Russia, Prussia, and Austria are the first spectacular manifestations of that new system.

Throughout the nineteenth century until the present day, the balance of power in the Balkans has been of concern to the nations of Europe. As early as 1790 Turkey concluded a treaty with Prussia in which the latter promised to go to war with Austria and Russia "because of the prejudice which the enemies, in crossing the Danube, have brought to the desirable and necessary

The Structure of the Balance of Power

balance of power." In the latter part of the nineteenth century one began to speak of an African balance of power with reference to a certain equilibrium among the colonial acquisitions of the great powers. Later on, the balance of power in the Western Hemisphere, in the Pacific, in the Far and Near East were added to the diplomatic vocabulary. One even spoke of an "Austrian equilibrium"; and of the Austrian monarchy with its antagonistic nationalities it was said that it "is constrained to apply to itself the rules of conduct which the powers of Europe with their perpetual rivalries follow with regard to each other."¹

It is not by accident that the autonomy of such local balance-of-power systems is the greater and their subordination to a dominant system the less noticeable, the more removed they are physically from the center of the struggle for power, the more they operate at the periphery of the dominant system, out of reach of the dominant nations. Thus an Italian balance of power could develop during the fifteenth century in relative autonomy, while the great nations of Europe were occupied in other regions. For the better part of the history of Western civilization the different balance-of-power systems of Asia, Africa, and America were entirely independent of the constellations of the European nations, to the point of being hardly known to them.

The balance of power in the Western Hemisphere up to the Second World War and in Eastern Europe until the end of the eighteenth century owe their relative autonomous development to their location at the periphery of the power centers of the time. The partitions of Poland which were intended to preserve the balance of power in Eastern Europe were executed by the directly interested nations without interference of any other nation. The alliance concluded in 1851 between Brazil and Uruguay against Argentina for the purpose of maintaining the balance of power in South America had only a very remote connection with the European balance of power. On the other hand, it is hardly justified to speak of an autonomous African balance of power. Since there are at present no indigenous nations in Africa which could compete for power with each other and with non-African nations, Africa is solely an object of the struggle for power centered elsewhere, that is, one of the elements in the European and world balance of power.

However, the more intimately a local balance of power is connected with the dominant one the less opportunity it has to operate autonomously and the more it tends to become merely a localized manifestation of the dominant balance of power. The balance of power within the German Confederation from Frederick the Great to the War of 1866 presents an intermediate situation between full autonomy and complete integration. It combines a certain degree of autonomy with integration into the dominant system. While the equilibrium between Prussia and Austria was, as we have seen,² a precondition for the preservation of the liberties of the members of the Germanic Confederation, this equilibrium was also indispensable for the maintenance of the European balance of power as a whole.

The German balance thus fulfilled a dual function: one within its own framework, another for the general system of which it was a part. Conversely,

¹ Albert Sorel, *L'Europe et la révolution française* (Paris: E. Plon, 1885), I, 443.

² See above, p. 133.

Politics among Nations

the fusion of Prussia and Austria or the domination of one by the other would not only have been destructive of the independence of the individual German states, but would as well have threatened the freedom of the other European nations with destruction. "If Europe," as Edmund Burke put it, "does not conceive the independence and the equilibrium of the empire to be in the very essence of the system of balance of power in Europe . . . all the politics of Europe for more than two centuries have been miserably erroneous."³ The perpetuation of the balance between Prussia and Austria was, therefore, in the interest not only of the other members of the Germanic Confederation, but of all European nations.

When, as a consequence of the War of 1866, Prussia and later Germany gained a permanent advantage over Austria which destroyed the balance between the two nations and made Germany predominant in Europe, it became one of the functions of the European balance of power to preserve at least the independence of Austria against infringement by its stronger neighbor. It was in consequence of that permanent European interest that after the First World War the victorious Allies sought by legal, economic, and political measures to prevent the fusion of Austria with Germany. Moreover, it was within the logic of this situation that Hitler regarded the annexation of Austria as a necessary stepping-stone on the road toward the overthrow of the European balance of power.

The balance of power in the Balkans has fulfilled a similar function since the last decades of the nineteenth century. Here, too, the maintenance of a balance of power among the Balkan nations has been regarded as a prerequisite for the maintenance of the European balance. Whenever the local balance was threatened, the great nations of Europe intervened in order to restore it. The statement of the Russian Czar at the beginning of the First World War, quoted above,⁴ clearly illustrates that connection.

2. STRUCTURAL CHANGES IN THE BALANCE OF POWER⁵

In recent times, however, the relations between the dominant balance of power and the local systems have shown an ever increasing tendency to change to the detriment of the autonomy of the local systems. The reasons for this development lie in the structural changes which the dominant balance of power has undergone since the First World War and which became manifest in the Second World War. We have already indicated the gradual expansion of the dominant balance-of-power system from Western and Central Europe to the rest of the continent and from there to other continents, until finally the First World War saw all the nations of the earth actively participating in a world-wide balance of power.

Hand in hand with the consummation of this expansion went a shift of the main weights of the balance from Europe to other continents. At the out-

³ *Loc. cit.*, IV, 330.

⁴ See above, pp. 141, 142.

⁵ For other structural changes, see above, pp. 139, 140, and below, Chapter XIX.

The Structure of the Balance of Power

break of the First World War in 1914, the main weights in the balance were predominantly European: Great Britain, France, and Russia in one scale, Germany and Austria in the other. At the end of the Second World War, the principal weights in each scale were either entirely non-European, as in the case of the United States, or predominantly non-European, as in the case of the Soviet Union. In consequence, the whole structure of the world balance of power has changed. At the end of the First World War and even at the beginning of the Second World War, the two scales of the balance, so to speak, were still in Europe: only the weights of the scales came from all over the earth. The main protagonists of the power contest and the principal stakes for which it was fought were still predominantly European. To paraphrase the already quoted words of Canning, non-European powers were called in only for the purpose of redressing the balance of power of Europe.

Today the balance of power of Europe is no longer the center of world politics around which local balances would group themselves, either in intimate connection or in lesser or greater autonomy. Today the European balance of power has become a mere function of the world-wide balance of which the United States and the Soviet Union are the main weights, placed on opposite scales. The distribution of power in Europe is only one of the concrete issues over which the power contest between the United States and the Soviet Union is being waged.

What is true of the formerly dominant system is true of all the traditional local systems as well. The balance of power in the Balkans, no less than the balances in the Near and Far East, have shared the fate of the general European system. They have become mere functions of the new world-wide balance, mere "theaters" where the power contest between the two great protagonists is fought out. One might say that of all the local balance-of-power systems only the South American system has retained a certain measure of autonomy, protected, as it is, by the predominance of the United States.⁶

⁶ For the causes for the destruction of most of those autonomous systems, see below, pp. 270 ff.

CHAPTER XII

Evaluation of the Balance of Power

If we consider especially its changed structure, how are we to evaluate the balance of power and to assess its future usefulness for the preservation of peace and security in the modern world?

In explaining its nature and operation, we have stressed its inevitable connection with, and protective function for, a multiple state system. (Throughout its history of more than four hundred years the policy of the balance of power succeeded in preventing any one state from gaining universal dominion. It also succeeded in preserving the existence of all members of the modern state system from the conclusion of the Thirty Years' War in 1648 to the partitions of Poland at the end of the eighteenth century. Yet universal dominion by any one state was prevented only at the price of warfare which from 1648 to 1815 was virtually continuous and in the twentieth century has twice engulfed practically the whole world. And the two periods of stability, one starting in 1648, the other in 1815, were preceded by the wholesale elimination of small states and were interspersed, starting with the destruction of Poland, by a great number of isolated acts of a similar nature.)

What is important for our discussion is the fact that these acts were accomplished in the name of the very principle of the balance of power whose chief claim to serve as the fundamental principle of the modern state system had been that it was indispensable for the preservation of the independence of the individual states. Not only did the balance of power fail to protect the independence of Poland, but the very principle of territorial compensation to each member for the territorial aggrandizement of any other member brought about the destruction of the Polish state. The destruction of Poland in the name of the balance of power was but the first and most spectacular instance of a series of partitions, annexations, and destructions of independent states which, from 1815 to the present, have all been accomplished in application of that same principle. Failure to fulfill its function for individual states and failure to fulfill it for the state system as a whole by any means other than actual or potential warfare points up the three main weaknesses of the balance of power as the guiding principle of international politics: its uncertainty, its unreality, and its inadequacy.

Evaluation of the Balance of Power

I. THE UNCERTAINTY OF THE BALANCE OF POWER

(The idea of a balance among a number of nations for the purpose of preventing any one of them from becoming strong enough to threaten the independence of the others is a metaphor taken from the field of mechanics. It was appropriate to the way of thinking of the sixteenth, seventeenth, and eighteenth centuries which liked to picture society and the whole universe as a gigantic mechanism, a machine or a clockwork, created and kept in motion by the divine watchmaker. Within that mechanism and within the smaller mechanisms composing it, the mutual relations of the individual parts could be, it was believed, exactly determined by means of mechanical calculations, and their actions and reactions accurately foreseen. The metaphor of two scales kept in balance by an equal distribution of weights on either side, thus providing the mechanism for the maintenance of stability and order on the international scene, has its origin in this mechanistic philosophy. It was applied to the practical affairs of international politics in the spirit of that philosophy.)

The balance of power, mechanically conceived, is in need of an easily recognizable, quantitative criterion by which the relative power of a number of nations can be measured and compared. For it is only by means of such a criterion, comparable to the pounds and ounces of a real pair of scales, that one can say with any degree of assurance that a certain nation tends to become more powerful than another or that they tend to maintain a balance of power between them. Furthermore, it is only by means of such a criterion that variations in power can be converted into quantitative units to be transferred from one scale into the other in order to restore the balance. The theory and practice of the balance of power found such a criterion, as we have seen, in territory, population, and armaments. The policies of compensations and of competitive armaments have served throughout the history of the modern state system as the practical application of that criterion.

But does the power of a nation actually repose in the extension of its territory? Is a nation the more powerful the more territory it possesses? Our examination of the factors which make for the power of a nation has shown that the answer can be in the affirmative only with qualifications so far-reaching as almost to nullify the affirmative character of the answer. The size of French territory was greater at the end of Louis XIV's reign than it had been at its beginning, but France was weaker at the end of the reign than it had been at its beginning. The same inverse relation of size of territory and national power is revealed by a comparison of Prussian territory and power at the death of Frederick the Great in 1786 with the same factors ten years later. Until the beginning of the nineteenth century, Spain and Turkey possessed vast territories exceeding in size the territories of any of the major nations of Europe. But they were counted among the weakest nations actively engaged in international politics. While geography, of which territorial expansion is a part, is indeed a factor which goes into the making of national power, it is but one among other factors. Even if one takes into con-

Politics among Nations

sideration, after the model of the compensations at the turn of the eighteenth century, the quality of the territory and the quality and quantity of the population within it, one still deals with fewer than all the factors of which the power of a nation is composed. The same holds true if one makes the quantity and quality of armaments the standard of comparison.

National character and above all national morale and the quality of government, especially in the conduct of foreign affairs, are the most important, but also the most elusive, components of national power. It is impossible for the observer of the contemporary scene or the explorer of future trends to assess even with approximate accuracy the relative contributions which these elements may make to the power of different nations. Furthermore, the quality of these contributions is subject to incessant change, unnoticeable at the moment the change actually takes place and revealed only in the actual test of crisis and war. Rational calculation of the relative strength of several nations, which is the very lifeblood of the balance of power, becomes a series of guesses the correctness of which can be ascertained only in retrospect.¹

An eighteenth-century opponent of the balance of power tried to demonstrate the absurdity of the calculations common at the time by asking which of two princes was more powerful: one who possessed three pounds of military strength, four pounds of statesmanship, five pounds of zeal, and two pounds of ambition, or one who had twelve pounds of military strength, but only one pound of all the other qualities? The author gives the advantage to the former prince, but whether his answer will be correct under all circumstances, even under the assumption that the quantitative determination of the relative weight of the different qualities were possible, is certainly open to question.

This uncertainty of power calculations is inherent in the nature of national power itself. It will, therefore, come into play even in the most simple pattern of the balance of power, that is, when one nation opposes another. This uncertainty is, however, immeasurably magnified when the weights in one or the other or in both scales are composed not of single units, but of alliances. Then it becomes necessary to compute not only one's own and the opponent's national power and to correlate one with the other, but to perform the same operation on the national power of one's allies and those of the opponent. The risk of guessing is greatly aggravated when one must assess the power of nations belonging to a different civilization from one's own. It is difficult enough to evaluate the power of Great Britain or of France. It is much more difficult to make a correct assessment of the power of China, Japan, or even the Soviet Union. The crowning uncertainty, however, lies in the fact that one cannot always be sure who are one's own allies and who are the opponent's. Alignments by virtue of alliance treaties are not always identical with the alliances which oppose each other in the actual contest of war.

One of the masters of the balance of power, Frederick the Great, made wise by sad experiences, called the attention of his successor to this problem. He said in his *Political Testament* of 1768:

¹ Cf. the extensive discussion of this problem above, Chapter VIII.

Evaluation of the Balance of Power

A frequently deceptive art of conjecture serves as foundation for most of the great political designs. One takes as one's point of departure the most certain factor one knows of, combines it, as well as one can, with other factors, but imperfectly known, and draws therefrom the most correct conclusions possible. In order to make that clearer, I shall give an example. Russia seeks to gain the support of the King of Denmark. She promises him the duchy of Holstein-Gottorp, which belongs to the Russian Grand Duke, and hopes in this way to gain his support forever. But the King of Denmark is fickle. How can one foresee all the ideas that might pass through that young head? The favorites, mistresses and ministers, who will take hold of his mind and offer him advantages from another power which appear to him to be greater than those offered by Russia, are they not going to make him change sides as an ally? A similar uncertainty, although every time in another form, dominates all operations of foreign policy so that great alliances have often a result contrary to the one planned by their members.²

These words, written when the classical period of the balance of power was drawing to a close, lose nothing of their poignancy when tested by the events of recent history. The composition of the alliances and counteralliances which one might have foreseen in August 1938, immediately before the denouement of the Czechoslovakian crisis, was certainly quite different from that which came to pass a year later, at the outbreak of the Second World War, and from that which developed more than two years later in consequence of the attack upon Pearl Harbor. No statesman, however great his knowledge, wisdom, and foresight, could have anticipated all these developments and based his balance-of-power policies upon them.

Immediately before the outbreak of the First World War in July 1914, it was by no means certain whether Italy would fulfill its obligations under the Treaty of the Triple Alliance and join Germany and Austria in a war against France, Great Britain, and Russia, whether it would remain neutral, or whether it would join the other side. Nor were the responsible statesmen of Germany and Austria certain, as late as July 30, 1914, that Russia would oppose Austria in order to maintain the balance of power in the Balkans. On that day, the British Ambassador to Germany reported to his government as the opinion held by these statesmen "that a general war was out of the question as Russia neither could, nor wanted to, go to war."³ According to the reports of the British Ambassador, the same belief was held at Vienna.

Nor was it evident to everybody concerned that Great Britain would enter the First World War on the side of France and Russia. As late as June 1, 1914, the British Secretary of Foreign Affairs declared in the House of Commons, confirming a declaration of the Prime Minister made the previous year, that Great Britain was bound by no obligation, unknown to Parliament and to the public, which might lead it into war. The British government was convinced that the secret exchange of letters between the Secretary of Foreign Affairs and the French Ambassador, which had taken place in November 1912, did not affect its freedom of action in case of a continental

² *Die politischen Testamente Friedrichs des Grossen* (Berlin, 1920), p. 192.

³ *British Documents, loc. cit.*, p. 361.

Politics among Nations

war. The French and Russian governments relied upon British intervention without being certain of it.¹ The British Ambassador reported from Berlin on July 30, 1914, that the French Ambassador "is continuously scolding me about England keeping her intentions so dark and says that the only way by which a general war can be prevented is by . . . stating . . . that England will fight on the side of France and Russia."² The governments of the Central Powers were altogether ignorant of this exchange of letters until after the First World War had actually broken out. Thus they started with the assumption that Great Britain would remain neutral; ". . . up to the last moment," reports the British Ambassador to Berlin, "they thought that England would not come in."³ Therefore, they arrived at the conclusion that the balance of power favored them. France and Russia started with the opposite assumption and arrived at the opposite conclusion.

The British policy of secrecy with regard to Britain's commitments toward France has been widely criticized on the ground that Germany would never have gone to war against France and Russia if it had known in advance that Great Britain would join the latter powers, that is, if it had been able to make its balance-of-power calculations in knowledge of the Anglo-French agreement of November 1912. However, neither the British nor the French and Russian governments were themselves entirely sure beforehand what this agreement would mean for the balance of power in August 1914. Therefore, even if the German government had known about the agreement it could not have been certain what the actual distribution of power would be on the eve of the First World War. It is in this condition of extreme uncertainty inherent in any balance-of-power system composed of alliances that one must seek the reasons for the failure of the balance of power to prevent the First World War. The German Under-Secretary for Foreign Affairs expressed spontaneously the insecurity to which the system of alliances and

¹ How ambiguous the situation was which this exchange of letters created is evidenced by the text of the letter which Sir Edward Grey, British Foreign Secretary, wrote on November 22, 1912, to Mr. Paul Cambon, the French Ambassador to Great Britain, and which is substantially reiterated by the French Ambassador's reply of the next day.

"From time to time in recent years the French and British naval and military experts have consulted together. It has always been understood that such consultation does not restrict the freedom of either Government to decide at any future time whether or not to assist the other by armed force. We have agreed that consultation between experts is not, and ought not to be regarded as, an engagement that commits either Government to action in a contingency that has not arisen and may never arise. The disposition, for instance, of the French and British fleets respectively at the present moment is not based upon an engagement to co-operate in war.

"You have, however, pointed out that, if either Government had grave reason to expect an unprovoked attack by a third Power, it might become essential to know whether it could in that event depend upon the armed assistance of the other.

"I agree that, if either Government had grave reason to expect an unprovoked attack by a third Power, or something that threatened the general peace, it should immediately discuss with the other whether both Governments should act together to prevent aggression and to preserve peace, and, if so, what measures they would be prepared to take in common. If these measures involved action, the plans of the General Staffs would at once be taken into consideration, and the Governments would then decide what effect should be given to them." *Collected Diplomatic Documents Relating to the Outbreak of the European War* (London: His Majesty's Stationery Office, 1915), p. 80.

The ambiguity of the situation is also well illustrated by the Czar's telegram quoted above. pp. 141, 142.

² *British Documents*, loc. cit., p. 361.

³ *Ibid.*, p. 363.

Evaluation of the Balance of Power

counteralliances had led when he said to the British Ambassador on August 1, 1914, that Germany, France, "and perhaps England" had been drawn into the war, "none of whom wanted war in the least and . . . that it came from 'this d—d system of alliances' which were the curse of modern times."⁷

2. THE UNREALITY OF THE BALANCE OF POWER

This uncertainty of all power calculations not only makes the balance of power incapable of practical application, it leads also to its very negation in practice. Since no nation can be sure that its calculation of the distribution of power at any particular moment in history is correct, it must at least make sure that, whatever errors it may commit, they will not put the nation at a disadvantage in the contest for power. In other words, the nation must try to have at least a margin of safety which will allow it to make erroneous calculations and still maintain the balance of power. To that effect, all nations actively engaged in the struggle for power must actually aim not at a balance, that is, equality of power, but at superiority of power in their own behalf. And since no nation can foresee how large its miscalculations will turn out to be, all nations must ultimately seek the maximum of power available to them. Only so can they hope to attain the maximum margin of safety commensurate with the maximum of errors they might commit. The limitless aspiration for power, potentially always present, as we have seen,⁸ in the power drives of nations, finds in the balance of power a mighty incentive to transform itself into an actuality.

Since the desire to attain a maximum of power is universal, all nations must always be afraid that their own miscalculations and the power increases of other nations might add up to an inferiority for themselves which they must at all costs try to avoid. Hence, it is the tendency of all nations who have gained an apparent edge over their competitors to consolidate that advantage and to use it for changing the distribution of power permanently in their favor. This can be done through diplomatic pressure by bringing the full weight of that advantage to bear upon the other nations, compelling them to make the concessions which will consolidate the temporary advantage into a permanent superiority. It can also be done by war. Since in a balance-of-power system all nations live in constant fear of being deprived at the first opportune moment, of their power position by their rivals, all nations have a vital interest in anticipating such a development and doing unto the others what they do not want the others to do unto them.

Preventive war, however abhorred in diplomatic language and abhorrent to democratic public opinion, is in fact a natural outgrowth of the balance of power. Here again, the events leading to the outbreak of the First World War are instructive; for it was on that occasion that foreign affairs were conducted for the last time according to the classical rules of the balance of

⁷ *British Documents, loc. cit.*, p. 284.

⁸ See above, p. 36 n. 16, p. 48.

Politics among Nations

power. Austria was resolved to change the balance of power in the Balkans in its favor once and for all. It believed that, while Russia was not yet ready to strike, its power was on the increase and that, therefore, postponement of decisive action would make the distribution of power less favorable to itself. Similar calculations were made in Berlin with respect to the distribution of power between Germany and Russia. Russia, on the other hand, was resolved not to permit Austria to change the distribution of power in its favor by crushing Serbia. Russia calculated that such an instant increase in the power of its prospective enemy might more than outweigh any probable future increase in its own power. It was partly in consideration of these Russian calculations that Great Britain refused until the last moment to declare openly its support of the Franco-Russian Alliance. As the British Ambassador to Germany put it on July 30, 1914: "A statement to that effect at the present stage, while it might cause Germany to hesitate, might equally urge Russia on; and if Russia attacked Austria, Germany would have to come in whether she feared the British fleet or not."⁹

It will forever be impossible to prove or disprove the claim that by its stabilizing influence the balance of power has aided in avoiding many wars. One cannot retrace the course of history, taking a hypothetical situation as one's point of departure. But, while nobody can tell how many wars there would have been without the balance of power, it is not hard to see that most of the wars which have been fought since the beginning of the modern state system have their origin in the balance of power. Three types of wars are intimately connected with the mechanics of the balance of power: preventive war, already referred to, where normally both sides pursue imperialistic aims, anti-imperialistic war, and imperialistic war itself.

The opposition, under the conditions of the balance of power, between one status quo nation or an alliance of them and one imperialistic power or a group of them is very likely to lead to war. In most instances, from Charles V to Hitler and Hirohito, they actually did lead to war. The status quo nations, which by definition are dedicated to peaceful pursuits and want only to hold what they have, will hardly be able to keep pace with the dynamic and rapid increase in power characteristic of a nation which is bent upon imperialistic expansion.

The relative increases in the power of Great Britain and France, on the one hand, and of Germany, on the other, from 1933 to the outbreak of the Second World War in 1939, illustrate vividly the different pace and dynamics in the power increases of status quo and imperialistic nations. In such an armament race the status quo nations are bound to lose, and their relative position cannot fail to deteriorate at an accelerated pace the longer the race lasts. Time is on the side of the imperialistic nations, and as time goes on, their scale sinks lower and lower under the ever increasing weight of their power, while the scale of the status quo nations rises ever higher. Thus it becomes more and more difficult for the latter to redress the balance, and they cannot fail to realize that, if the trend is not forcibly reversed, the position of the imperialistic nations must become well-nigh unassailable, while

⁹ *British Documents, loc. cit.*, p. 361.

Evaluation of the Balance of Power

their own chances for redressing the balance will be irretrievably lost. This was the situation in which Great Britain and France found themselves in September 1939. In such a situation, war with its incalculable possibilities seems to be the only alternative to an unglorious absorption into the power orbit of the imperialistic nation. The dynamics of international politics, as they play between status quo and imperialistic nations, lead of necessity to such a disturbance of the balance of power that war appears as the only policy which offers the status quo nations at least a chance to redress the balance of power in their favor.

Yet the very act of redressing the balance carries within itself the elements of a new disturbance. The dynamics of power politics as outlined previously make this development inevitable. Yesterday's defender of the status quo is transformed by victory into the imperialist of today against whom yesterday's vanquished will seek revenge tomorrow. The ambition of the victor who took up arms in order to restore the balance, as well as the resentment of the loser who could not overthrow it, tend toward making the new balance a virtually invisible point of transition from one disturbance to the next. Thus the balancing process has frequently led to the substitution of one predominant power disturbing the balance for another one. Charles V of Hapsburg was thwarted in his aspirations for a universal monarchy by France, only to be succeeded by Louis XIV of France whose similar aspirations united all of Europe against him. Once the balance had been restored against him, a new disturbing factor arose in Frederick the Great of Prussia. The bid for world domination by France under Napoleon I was followed by a similar bid on the part of the Holy Alliance under the leadership of the most potent of Napoleon's former enemies, Austria and Russia. The defeat of the latter brought in its wake the rise of Prussia to dominance in Germany and of Germany in Europe. Twenty years after its defeat in the First World War Germany was again the predominant nation in Europe, while Japan had risen to a similar position in Asia. The very moment these two nations were removed as active factors in the balance of power a new power contest took shape between the United States and the Soviet Union.

(a) *The Balance of Power as Ideology*

Our discussion has thus far proceeded under the assumption that the balance of power is a device for the self-defense of nations whose independence and existence is threatened by a disproportionate increase in the power of other nations. What we have said of the balance of power is true under the assumption that the balance of power is used *bona fide* for its avowed purposes of self-protection. Yet we have already seen how the power drives of nations take hold of ideal principles and transform them into ideologies in order to disguise, rationalize, and justify themselves. They have done this with the balance of power. What we have said above about the popularity of anti-imperialistic ideologies in general applies to the balance of power.

A nation seeking empire has often claimed that all it wanted was equilibrium. A nation seeking only to maintain the status quo has often tried to give a change in the status quo the appearance of an attack upon the balance

Politics among Nations

of power. When, at the outbreak of the Seven Years' War in 1756, England and France found themselves at war, British writers justified the policy of their country in terms of the necessities of the European balance of power, while French publicists claimed that France was compelled to oppose English supremacy on the sea and in North America in order to restore the "balance of commerce."

When the Allied Powers in 1813 submitted their conditions of peace to Napoleon, they invoked the principle of the balance of power. When Napoleon rejected these conditions, he, too, invoked "the equilibrium of rights and interests." When, early in 1814, the Allies confronted the representative of Napoleon with an ultimatum demanding that France, in the name of the balance of power, give up all conquests made since 1792, the French representative replied: "Did the allied sovereigns not . . . want to establish a just equilibrium in Europe? Do they not declare that they want it still today? To maintain the same relative power which she always has had this is also the sole actual desire of France. But Europe is no longer what it was twenty years ago." And he arrived at the conclusion that in the light of geography and strategy even the retention by France of the left bank of the Rhine would hardly be sufficient to restore the balance of power in Europe. The allied representatives declared in reply: "France, by retreating into the dimensions of 1792, remains one of the strongest powers on the continent by virtue of her central position, her population, the riches of her soil, the nature of her frontiers, the number and distribution of her strong points." Thus both sides tried to apply the principle of the balance of power to the same situation and arrived at irreconcilable results with the effect that the efforts to bring the war to a conclusion ended in failure.

A similar situation occurred forty years later for similar reasons. At the Conference of Vienna, which in 1855 tried to bring the Crimean War to an end, Russia agreed with its opponents to make the maintenance of the balance of power in the Black Sea the basis of the settlement. Yet, while Russia declared that "the preponderance of Russia in the Black Sea . . . is absolutely necessary for the European equilibrium," its adversaries sought to put an end to that preponderance and declared that the Russian Navy was "still too strong in comparison to the Turkish fleet." Peace was concluded in 1856 on the latter terms.

The difficulties in assessing correctly the relative power positions of nations has made the invocation of the balance of power one of the favored ideologies of international politics. Thus it has come about that the term is being used in a very loose and unprecise manner. When a nation would like to justify one of its steps on the international scene, it is likely to refer to it as serving the maintenance or restoration of the balance of power. When a nation would like to discredit certain policies pursued by another nation, it is likely to condemn them as a threat to, or a disturbance of, the balance of power. Since it is the inherent tendency of the balance of power in the proper meaning of the term to preserve the status quo, the term has, in the vocabulary of status quo nations, become a synonym for the status quo and for any distribution of power existing at any particular moment. Any change in the existing distribution of power is, therefore, opposed as disturbing the balance

Evaluation of the Balance of Power

of power. In this way a nation interested in the preservation of a certain distribution of power tries to make its interest appear to be the outgrowth of the fundamental, universally accepted principle of the modern state system and, hence, to be identical with an interest common to all nations. The nation itself, far from defending a selfish, particular concern, poses as the guardian of that general principle, that is, as the agent of the international community.

In this sense one speaks, for instance, of the balance of power in the Western Hemisphere which might be disturbed by the policies of non-American nations, or of the balance of power in the Mediterranean which must be defended against Russian intrusion. Yet what one means to defend in either case is not the balance of power, but a particular distribution of power regarded as favorable to a particular nation or group of nations. The *New York Times* wrote in one of its reports on the Foreign Ministers' Conference in Moscow in 1947 that "The new unity of France, Britain and the United States . . . may be only temporary but it does alter the balance of power perceptibly."¹⁰ What it actually meant was not that the balance of power in the proper meaning of the term had been altered, but that the distribution of power which existed after the conference was more favorable to the Western powers than the one that existed before.

The use of the balance of power as an ideology greatly increases the innate difficulties which the mechanics of the balance of power present to the impartial observer. Yet it must be noted that the ready use as an ideology to which the balance of power lends itself is not an accident. It is a potentiality inherent in its very essence. The contrast between pretended precision and the actual lack of it, between the pretended aspiration for balance and the actual aim of predominance—this contrast which, as we have seen, is of the very essence of the balance of power, makes the latter in a certain measure an ideology to begin with. The balance of power thus appears as a system of international politics which assumes a reality and a function that it actually does not have, and which, therefore, tends to disguise, rationalize, and justify international politics as it actually is.

3. THE INADEQUACY OF THE BALANCE OF POWER

New light will be shed upon the nature of the balance of power by a consideration of the actual contribution which the balance of power, during the period of its flowering in the seventeenth, eighteenth, and nineteenth centuries, has made to the stability of the modern state system and to the preservation of the independence of its members. Was it the balance of power alone which attained these beneficial results, or was, during that period of history, another factor in operation without which the balance of power could not have attained these results?

¹⁰ April 27, 1947, p. E3.

Politics among Nations

a) Restraining Influence of a Moral Consensus

Gibbon pointed to such a factor in 1781 at a moment when his country was fighting a losing war with its American colonies, France, Spain, and Holland. He then proposed:

. . . to consider Europe as one great republic, whose various inhabitants have attained almost the same level of politeness and cultivation. The balance of power will continue to fluctuate, and the prosperity of our own or the neighboring kingdoms may be alternately exalted or depressed; but these events cannot essentially injure our general state of happiness, the system of arts, and laws, and manners, which so advantageously distinguish, above the rest of mankind, the Europeans and their colonies. . . . The abuses of tyranny are restrained by the mutual influence of fear and shame; republics have acquired order and stability; monarchies have imbibed the principles of freedom, or, at least, of moderation; and some sense of honour and justice is introduced into the most defective constitutions by the general manners of the times. In peace, the progress of knowledge and industry is accelerated by the emulation of so many active rivals: in war, the European forces are exercised by temperate and undecisive contests.¹¹

The awareness of an intellectual and moral unity upon whose foundations the balance of power reposes and which makes its beneficial operations possible was the common possession of the great writers of that age. We shall mention only three of them, Fénelon, Rousseau, and Vattel.

Fénelon, the great philosopher of the reign of Louis XIV and mentor of the latter's grandson, wrote in the *Supplement to the Examination of Conscience about the Duties of Royalty*:

This attention for the maintenance of a kind of equality and of equilibrium among neighboring nations assures tranquillity for all. In this respect, all nations which are neighbors and have commercial relations form a great body and a kind of community. For instance, christendom forms a kind of general republic which has its common interests, fears, and precautions. All members which compose this great body owe it to each other for the common good, and owe it also to themselves, in the interest of national security, to forestall any step on the part of any member which might overturn the equilibrium and bring about the

~~~~~

<sup>11</sup> *The Decline and Fall of the Roman Empire* (The Modern Library Edition), II, 93-5. A similarly brilliant account of the beneficial results of the balance of power is found in an anonymous contribution to the *Edinburgh Review*, Vol. I, January 1803, p. 348: "But had it not been for that wholesome jealousy of rival neighbours, which modern politicians have learned to cherish, how many conquests and changes of dominion would have taken place, instead of wars, in which a few useless lives were lost, and some superfluous millions were squandered? How many fair portions of the globe might have been deluged in blood, instead of some hundreds of sailors fighting harmlessly on the barren plains of the ocean, and some thousands of soldiers carrying on a scientific, and regular, and quiet, system of warfare, in countries set apart for the purpose, and resorted to as the arena where the disputes of nations may be determined? We may indeed look to the history of the last century as the proudest area in the annals of the species; the period most distinguished for learning, and skill, and industry; for the milder virtues, and for common sense; for refinement in government, and an equal diffusion of liberty; above all, for that perfect knowledge of the arts of administration, which has established certain general rules of conduct among nations; has prevented the overthrow of empires, and the absorption of weak states into the bodies of devouring neighbours; has set bounds to the march of conquest, and rendered the unsheathing of the sword a measure of the last adoption; whereas, in other times, it was always resorted to in the first instance."

## *Evaluation of the Balance of Power*

inevitable ruin of all the other members of the same body. Whatever changes or impairs this general system of Europe is too dangerous and brings in its train infinite evils.<sup>12</sup>

Rousseau took up the same theme by stating that "The nations of Europe form among themselves an invisible nation. . . . The actual system of Europe has exactly that degree of solidity which maintains it in a state of perpetual agitation without overturning it."<sup>13</sup> And, according to Vattel, the most influential of the eighteenth-century writers on international law:

Europe forms a political system, a body where the whole is connected by the relations and different interests of nations inhabiting this part of the world. It is not as anciently a confused heap of detached pieces, each of which thought itself very little concerned in the fate of others, and seldom regarded things which did not immediately relate to it. The confined attention of sovereigns . . . makes Europe a kind of republic, the members of which, though independent, unite, through the ties of common interest, for the maintenance of order and liberty. Hence arose that famous scheme of the political equilibrium or balance of power; by which is understood such a disposition of things as no power is able absolutely to predominate, or to prescribe laws to others.<sup>14</sup>

The statements of the writers are echoed in the declarations of the statesmen. From 1648 to the French Revolution of 1789, the princes and their advisers took the moral and political unity of Europe for granted and referred only in passing to the "republic of Europe," "the community of Christian princes," or "the political system of Europe." But the challenge of the Napoleonic Empire compelled them to make explicit the moral and intellectual foundations upon which the old balance of power had reposed. The Holy Alliance and the Concert of Europe, both of which shall be dealt with later,<sup>15</sup> are attempts at giving institutionalized direction to these moral and intellectual forces which had been the lifeblood of the balance of power.

The Treaty of the Holy Alliance of September 26, 1815, obligated its signatories — all the sovereigns of Europe except three — to nothing more than to act in relation to each other and to their subjects in accordance with Christian principles. Yet the other treaties, which tried to reconstitute the European political system and which are popularly known by the name of the Holy Alliance, were directed against the recurrence of revolution anywhere, especially, of course, in France. Since the French Revolution had been the great dynamic force which had destroyed the balance of power, it was believed that any revolution would carry with it a similar threat. Thus the principle of legitimacy and the inviolability of the frontiers of 1815 became the foundation stones upon which at least Austria, Prussia, and Russia tried to re-erect the political structure of Europe.

As late as 1860, when France obtained the cession of Savoy and Nice as compensation for the increase of territory obtained by Sardinia in Italy, England intervened by invoking one of the principles of 1815. "Her Majesty's

<sup>12</sup> *Œuvres* (Paris, 1870), III, 349, 350.

<sup>13</sup> *Œuvres complètes*, IX, 469.

<sup>14</sup> *The Law of Nations* (Philadelphia, 1829), Book III, Chapter III, pp. 377-8.

<sup>15</sup> See below, Chapter XXV.

## *Politics among Nations*

Government," Earl Russell, the British Foreign Secretary, wrote to the British Ambassador to France, "must be allowed to remark that a demand for cession of a neighbor's territory, made by a State so powerful as France, and whose former and not very remote policy of territorial aggrandizement brought countless calamities upon Europe, cannot well fail to give umbrage to every State interested in the Balance of Power and in the maintenance of the general peace."

The Concert of Europe — diplomacy by conferences among the great powers which would meet all threats to the political system by concerted action — became the instrument by which first the principles of the Holy Alliance and then, after the latter's disintegration culminating in the liberal revolutions of 1848, the common interests of Europe were to be realized. The Concert of Europe functioned on many occasions during the century from its inception in 1814 to the outbreak of the First World War in 1914. The conception underlying it, that is, the political unity of Europe, or, in the words of Castlereagh, "the general system of Europe," was referred to in many official declarations. Thus the allied powers declared toward the end of 1813 that they "shall not lay down their arms . . . before the political status of Europe has been anew reaffirmed and before immutable principles have taken their rights over vain pretensions in order to assure Europe a real peace." In the declaration of February 5, 1814, from which the Concert of Europe is generally dated, the representatives of Austria, Great Britain, Prussia, and Russia stated that they did not speak solely in the name of their respective countries, "but in the name of Europe which forms but a single whole."

The same nations, which were joined by France, established in Protocol 19 of the Conference of London of 1831 the independence of Belgium and, in the interest of the balance of power, put its neutrality under their joint guaranty. In justification, they declared: "Every nation has its laws, but Europe, too, has her law; the social order has given it to her." During the Franco-Prussian War of 1870, French Minister Thiers, searching in vain for aid from the other European nations in order to prevent the overthrow of the balance of power by Germany, complained that "Europe was not to be found." In that phrase he paid his respects to the same principle of European unity which since 1648 has been the lifeblood of the balance of power. It was to the same principle that British Foreign Secretary Sir Edward Grey appealed in vain when on the eve of the First World War he invited the nations of Europe to a conference in order to settle their differences. One might even say that British Prime Minister Neville Chamberlain, when in 1938 he forced Czechoslovakia to cede the Sudetenland to Nazi Germany, acted under the mistaken assumption that the moral, intellectual, and political unity of Europe did still exist and that Nazi Germany formed an integral part of it.

### *✓ Moral Consensus of the Modern State System*

The confidence in the stability of the modern state system that emanates from all these declarations and actions derives, it will be noted, not from the

## *Evaluation of the Balance of Power*

balance of power, but from a number of elements, intellectual and moral in nature, upon which both the balance of power and the stability of the modern state system repose. "In politics as in mechanics," as John Stuart Mill put it, "the power which is to keep the engine going must be sought for *outside* the machinery; and if it is not forthcoming, or is insufficient to surmount the obstacles which may reasonably be expected, the contrivance will fail."<sup>10</sup> What, for instance, Gibbon has pointed to with particular eloquence and insight as the fuel which keeps the motor of the balance of power moving are the intellectual and moral foundations of Western civilizations, the intellectual and moral climate within which the protagonists of eighteenth-century society moved and which permeated all their thoughts and actions. These men knew Europe as "one great republic" with common standards of

<sup>10</sup> *Considerations on Representative Government* (New York: Henry Holt and Company, 1882), p. 21. Cf. also the penetrating remarks on pp. 235-6 on the importance of the moral factor for the maintenance of the balance of power in domestic politics: "When it is said that the question is only one of political morality, this does not extenuate its importance. Questions of constitutional morality are of no less practical moment than those relating to the constitution itself. The very existence of some governments, and all that renders others enduring, rests on the practical observance of doctrines of constitutional morality; traditional notions in the minds of the several constituted authorities, which modify the use that might otherwise be made of their powers. In unbalanced governments — pure monarchy, pure aristocracy, pure democracy — such maxims are the only barrier which restrains the government from the utmost excesses in the direction of its characteristic tendency. In imperfectly balanced governments, where some attempt is made to set constitutional limits to the impulses of the strongest power, but where that power is strong enough to overstep them with at least temporary impunity, it is only by doctrines of constitutional morality, recognized and sustained by opinion, that any regard at all is preserved for the checks and limitations of the constitution. In well-balanced governments, in which the supreme power is divided, and each sharer is protected against the usurpations of the others in the only manner possible, namely, by being armed for defense with weapons as strong as the others can wield for attack, the government can only be carried on by forbearance on all sides to exercise those extreme powers, unless provoked by conduct equally extreme on the part of some other sharer of power; and in this case we may say that only by the regard paid to maxims of constitutional morality is the constitution kept in existence."

Cf. on this point also the analogy between industrial warfare and the international balance of power in R. H. Tawney, *The Acquisitive Society* (New York: Harcourt, Brace and Company, 1920), pp. 40, 41: "That motive produces industrial warfare, not as a regrettable incident, but as an inevitable result. It produces industrial war, because its teaching is that each individual or group has a right to what they can get, and denies that there is any principle, other than the mechanism of the market, which determines what they ought to get. For, since the income available for distribution is limited, and since, therefore, when certain limits have been passed, what one group gains another group must lose, it is evident that if the relative incomes of different groups are not to be determined by their functions, there is no method other than mutual self-assertion which is left to determine them. Self-interest, indeed, may cause them to refrain from using their full strength to enforce their claims, and, in so far as this happens, peace is secured in industry, as men have attempted to secure it in international affairs, by a balance of power. But the maintenance of such a peace is contingent upon the estimate of the parties to it that they have more to lose than to gain by an overt struggle, and is not the result of their acceptance of any standard of remuneration as an equitable settlement of their claims. Hence it is precarious, insincere and short. It is without finality, because there can be no finality in the mere addition of increments of income, any more than in the gratification of any other desire for material goods. When demands are conceded the old struggle recommences upon a new level, and will always recommence as long as men seek to end it merely by increasing remuneration, not by finding a principle upon which all remuneration, whether large or small, should be based."

See also p. 50: "But the balance, whether in international politics or in industry, is unstable, because it reposes not on the common recognition of a principle by which the claims of nations and individuals are limited, but on an attempt to find an equipoise which may avoid a conflict without adjuring the assertion of unlimited claims. No such equipoise can be found, because, in a world where the possibilities of increasing military or industrial power are illimitable, no such equipoise can exist." (Reprinted by permission of the publisher.)

## *Politics among Nations*

"politeness and cultivation" and a common "system of arts, and laws, and manners." The common awareness of these common standards restrained their ambitions "by the mutual influence of fear and shame," imposed "moderation" upon their actions, and instilled in all of them "some sense of honour and justice." In consequence, the struggle for power on the international scene was in the nature of "temperate and undecisive contests."

Of the temperateness and undecisiveness of the political contests, from 1648 to the Napoleonic Wars and then again from 1815 to 1914, the balance of power is not so much the cause as the metaphorical and symbolic expression or, at best, the technique of realization. Before the balance of power could impose its restraints upon the power aspirations of nations through the mechanical interplay of opposing forces, the competing nations had first to restrain themselves by accepting the system of the balance of power as the common framework of their endeavors. However much they desired to alter the distribution of the weight in the two scales, they had to agree in a silent compact, as it were, that, whatever the outcome of the contest, the two scales would still be there at the end of it. They had to agree that, however high one might have risen and however low the other might have sunk, the scales would still be joined together as a pair, hanging from the same beam and, hence, able to rise and fall again as the future constellation of weights would determine. Whatever changes in the status quo nations might seek, they all had at least to recognize as unchangeable one factor, the existence of a pair of scales, the "status quo" of the balance of power itself. And whenever a nation might tend to forget that indispensable precondition of independence and stability, as Austria did in 1756 with regard to Prussia, or France from 1919-23 with regard to Germany, the consensus of all the other nations would not allow it to forget that precondition for long.

This consensus grew in the intellectual and moral climate of the age and drew its strength from the actual power relations which under normal conditions made an attempt at overthrowing the system of the balance of power itself a hopeless undertaking. This consensus, in turn, as an intellectual and moral force, reacted upon the intellectual and moral climate and upon the power relations, strengthening the tendencies toward moderation and equilibrium. As Professor Quincy Wright has put it:

The States were so bounded and organized that aggression could not succeed unless it was so moderated and so directed that the prevailing opinion of the Powers approved it. Such approval was generally given to the Balkan revolts which gradually disintegrated the Ottoman Empire, to the Belgian revolt which separated that country from the Netherlands, to Prussian and Sardinian aggressions which united modern Germany and Italy, and to numerous aggressions in Africa, Asia and the Pacific which increased European empires, and extended European civilization to these areas.<sup>17</sup>

It is this consensus, both child and father, as it were, of common moral standards and a common civilization as well as of common interests, which kept in check the limitless desire for power, potentially inherent, as we know,

<sup>17</sup> "The Balance of Power," in Weigert and Stefansson, *Compass of the World* (New York: The Macmillan Company, 1944), pp. 53-4.



## *Evaluation of the Balance of Power*

in all imperialisms, and prevented it from becoming a political actuality. Where such a consensus no longer exists or has become weak and is no longer sure of itself, as in the period starting with the partitions of Poland and ending with the Napoleonic Wars, the balance of power is incapable of fulfilling its functions for international stability and national independence.

Such a consensus prevailed from 1648 to 1772 and from 1815 to 1933. In the former period, the state system resembled nothing so much as a competitive society of princes, each of whom accepted the reason of state, that is, the rational pursuit, within certain moral limitations, of the power objectives of the individual state, as the ultimate standard of international behavior. Each expected, and was justified in expecting, everybody else to share this standard. The passions of the religious wars yielded to the rationalism and the skeptical moderation of the Enlightenment. In that tolerant atmosphere, national hatreds and collective enmities, nourished by principles of any kind, could hardly flourish. Everybody took it for granted that the egotistical motives which animated his own actions drove all others to similar actions. It was then a matter of skill and luck who would come out on top. International politics became indeed an aristocratic pastime, a sport for princes, all recognizing the same rules of the game and playing for the same limited stakes.

After the interlude of the Napoleonic Wars, the dual fear of revolution and of a renewal of French imperialism called into being the morality of the Holy Alliance with its blend of Christian, monarchical, and European principles. The Concert of Europe in the latter part of the nineteenth century, and the League of Nations after the First World War, added to this heritage the idea of the national state. This idea became, as principle of national self-determination, one of the cornerstones upon which successive generations, from the liberal revolutions of 1848 to the outbreak of the Second World War, tried to erect a stable political structure. What the French Foreign Minister De la Valette wrote in 1866 to a French diplomatic representative became one of the basic convictions of this period of history — proclaimed again by Woodrow Wilson and made one of the standards of the Peace Treaties of 1919 — : "The emperor . . . sees a real equilibrium only in the satisfied wishes of the nations of Europe."<sup>18</sup>

---

<sup>18</sup> The importance of the moral factor for the preservation of the independence of small nations is well pointed out by Alfred Cobban, *National Self-Determination* (Chicago: University of Chicago Press, 1948) pp. 170, 171: "But even the policies of great empires are influenced by the climate of opinion, and there has for long been a prejudice in favour of the rights of small independent states. With the sources of this prejudice we need not concern ourselves, but its existence is a fact which the student of international affairs cannot ignore. The various factors we have mentioned all undoubtedly have their importance, but in our opinion it was not the strength of national feeling in the smaller states, or even the effects of the balance of power, so much as the general recognition that the destruction of an independent sovereignty was an exceptional, and normally an unjustifiable, act which ultimately protected many of the small states of Europe, some no larger than a single city, from absorption by the greater powers. Even in the eighteenth century, when the power of the larger states was increasing rapidly, contemporary opinion, influenced by the classical city-state ideal, held up the smaller states for admiration and believed in their independence. During the nineteenth century the growth of the nationalist ideal did much to undermine this view, but in 1919, as we have seen, it still exercised considerable influence."

## *Politics among Nations*

What is left of this heritage today? What kind of consensus unites the nations of the world in the period following the Second World War? Upon the examination of the component elements of this consensus will depend the estimate of the role which the balance of power can be expected to play today for the freedom and stability of the community of nations.

*PART FIVE*

LIMITATIONS  
OF INTERNATIONAL POWER:  
INTERNATIONAL MORALITY  
AND WORLD PUBLIC OPINION



## CHAPTER XIII

# *Ethics, Mores, and Law as Restraints on Power*

We have seen in the preceding chapter that power is a crude and unreliable method of limiting the aspirations for power on the international scene. If the motivations behind the struggle for power and the mechanisms through which it operates were all that needs to be known about international politics, the international scene would indeed resemble the state of nature described by Hobbes as a "war of every man against every man."<sup>1</sup> International politics would be governed exclusively by those considerations of political expediency of which Machiavelli has given the most acute and candid account. In such a world the weak would be at the mercy of the strong. Might would indeed make right.

Actually, however, the very threat of such a world where power reigns not only supreme, but without rival, engenders that revolt against power, which is as universal as the aspiration for power itself. To stave off this revolt, to pacify the resentment and opposition that arise when the drive for power is recognized for what it is, those who seek power employ, as we have seen, ideologies for the concealment of their aims. What is actually aspiration for power, then, appears to be something different, something that is in harmony with the demands of reason, morality, and justice. The substance, of which the ideologies of international politics are but the reflection, is to be found in the normative orders of ethics, mores, and law.

From the Bible to the ethics and constitutional arrangements of modern democracy, the main function of these normative systems has been to keep aspirations for power within socially tolerable bounds. All ethics, mores, and legal systems dominant in Western civilization recognize the ubiquity of power drives and condemn them. Conversely, political philosophies, such as Machiavelli's and Hobbes's, which regard the ubiquity of power drives as an ultimate fact of social life to be accepted rather than condemned and restrained, have met with the disapproval of prevailing opinion. They have lacked the intellectual and practical influence which has made political

---

<sup>1</sup> *Leviathan*, Chapter XIII.

## *Politics among Nations*

philosophies, such as St. Augustine's and Locke's, potent forces in Western civilization.

On the other hand, that very tradition of Western civilization which attempts to restrain the power of the strong for the sake of the weak has been opposed as effeminate, sentimental, and decadent. The opponents have been those who, like Nietzsche, Mussolini, and Hitler, not only accept the will to power and the struggle for power as elemental social facts, but glorify their unrestrained manifestations and postulate this absence of restraint as an ideal of society and a rule of conduct for the individual. But in the long run philosophies and political systems which have made the lust and the struggle for power their mainstay have proved impotent and self-destructive. Their weakness demonstrates the strength of the Western tradition which seeks, if not to eliminate, at least to regulate and restrain the power drives which otherwise would either tear society apart or else deliver the life and happiness of the weak to the arbitrary will of those in power.

It is at these two points that ethics, mores, and law intervene in order to protect society against disruption and the individual against enslavement and extinction. When a society or certain of its members are unable to protect themselves with their own strength against the power drives of others, when, in other words, the mechanics of power politics are found wanting, as sooner or later they must, the normative systems try to supplement power politics with their own rules of conduct. This is the message the normative systems give to strong and weak alike: Superior power gives no right, either moral or legal, to do with that power all that it is physically capable of doing. Power is subject to limitations, in the interest of society as a whole and in the interest of its individual members, which are not the result of the mechanics of the struggle for power, but are superimposed upon that struggle in the form of norms or rules of conduct by the will of the members of society themselves.

Three types of norms or rules of conduct operate in all higher societies: ethics, mores, and law. Their distinctive characteristics have been much debated in the literature of philosophy and jurisprudence. For the purpose of this study it is sufficient to point out that every rule of conduct has two elements: the command and the sanction. No particular command is peculiar to any particular type of norm — "thou shalt not kill" can be a command of ethics, mores, or law. It is the sanction that differentiates these three different types of rules of conduct.

"Thou shalt not kill" is a command of ethics, mores, or law according to whether, in case of its violation, a sanction peculiar to ethics or to mores or to law is applied to punish the violator and prevent further violations. If A kills B and afterward feels pangs of conscience or of remorse, we are in the presence of a sanction peculiar to ethics and, hence, of an ethical norm. If A kills B and unorganized society reacts with spontaneous demonstrations of disapproval, such as business boycott, social ostracism, and the like, we have to do with a sanction peculiar to the mores, and, hence, to a norm of the mores. If, finally, A kills B and organized society reacts in the form of a rational procedure with predetermined police action, indictment, trial, verdict, and punishment, the sanction is of a legal nature and the norm, therefore, belongs in the category of law.

## *Ethics, Mores, and Law as Restraints on Power*

All domestic societies are regulated by an intricate maze of rules of conduct of this kind, supporting or contradicting each other or operating independently. The more important society considers those interests and values which it tries to safeguard by rules of conduct, the stronger are the sanctions with which it threatens an infraction of its rules. Society exerts its greatest pressure and, therefore, has the best chance of enforcing its rules of conduct against its recalcitrant members when it brings all the different kinds of sanctions at its disposal simultaneously to bear upon the infractor of its rules. It is weakest and, therefore, its sanctions are most likely to be ineffective when only one type of sanction supports its interests and values. When one rule of conduct requires an action which another rule of conduct condemns, the fate of the interest or value concerned depends upon the relative strength of the sanctions supporting the contradictory commands.

Against a threat to its own existence by treason or by revolution, or a threat to the existence of its individual members by murder, society marshals all three types of sanction. Thus ethics, mores, and law, reinforcing each other, give threefold protection to the life of society and to the lives of the individuals who compose it. The would-be traitor or killer faces the pangs of his conscience, the spontaneous reactions of society in the form, for instance, of ostracism, and the punishment of the law. The same situation prevails where not the existence of society or of its individual members, but their property is to be protected. Property, too, is surrounded by the triple wall of ethics, mores, and law. Between the would-be thief and cheat and the property he covets, society interposes all the sanctions it is able to employ.

Where less highly priced interests and values are at stake, society may call upon only one type of sanction. Thus certain kinds of competitive practices in business and politics, such as lying, are opposed only by ethics. The mores will come into play only under extreme conditions, if, for instance, the amount and degree of lying exceed the measure which society regards as tolerable. The law will remain silent in the case of ordinary lying, if for no other reason than that no law prohibiting it can be enforced. It will speak only in cases of qualified lying, such as perjury and cheating, where the lie threatens interests and values beyond mere truth. The rules of fashion, on the other hand, are enforced exclusively by the mores, for the issues involved are not important enough for ethics and law to be concerned about them. It is, finally, the law alone which takes cognizance of violations of traffic regulations. Ethics and mores do not participate in their enforcement; for to establish some kind of mechanical order in the field of traffic the sanctions of the law are generally sufficient.

The problem of the relative strength of different injunctions becomes acute when there is conflict between different rules of conduct. The classic example, much discussed in the literature of jurisprudence, of a conflict between two rules of the same legal system is the prohibition of dueling in the criminal codes of certain European countries, while the military codes of the same countries require officers to settle certain disputes by way of duels. A system of ethics which commands us to obey God rather than man and at the same time to give unto Caesar what is Caesar's presents a similar conflict when a law of the state contradicts one of God's commandments. Conflicts of this kind

## *Politics among Nations*

are particularly frequent in the political sphere. Rival governments — a revolutionary government and a legitimate government, a government in exile and a "Quisling" government — demand obedience from the same group of people. The rules of conduct with which a politician is expected to comply are often at odds with the norms which address themselves to all members of society. The ethics and mores of politics are generally considered to permit greater leeway than the general ethics and mores of society in certain actions, such as "campaign oratory" and promises in general.

Conflicts between different rules of conduct are decided by the relative pressure which the sanctions of the conflicting rules are able to exert upon the will of the individual. Unable to comply with all the norms addressed to him at the same time, he must choose the one to obey and violate the others. The relative strength of these pressures is, in turn, the expression of the relative strength of the social forces which support one set of values and interests against another. Thus the normative order of society whose purpose it is to keep the power aspirations of its individual members within socially tolerable bounds is itself in a certain measure the result of social forces contending with each other for the domination of society.

Social life consists to an overwhelming extent in continuous reactions, which have become largely automatic, to the pressures which society exerts upon its members through its rules of conduct. These rules of conduct watch over the individual from morning till night, molding his actions into conformity with the standards of society. One might even say that society as a dynamic force is nothing but the sum total of its rules of conduct imposing patterns of action upon its members. What we call civilization is in a sense nothing but the automatic reactions of the members of a society to the rules of conduct by which that society endeavors to make its members conform to certain objective standards, to restrain their aspirations for power, and to domesticate and pacify them in all socially important respects. The civilization with which we are here of course mainly concerned — Western civilization — has been to a large extent successful in this endeavor. Western civilization has not, however, as many nineteenth- and twentieth-century writers believed, altogether banished the struggle for power from the domestic scene and replaced it with something different and better, such as co-operation, harmony, permanent peace, nor is it on its way to do so. This misconception of the role which the aspirations and the struggle for power play in politics has been treated in the first chapter of this book.

The best that Western civilization has been able to achieve — which is, as far as we can see, the best that any civilization can achieve — has been to mitigate the struggle for power on the domestic scene, to civilize its means, and to direct it toward objectives, which, if attained, minimize the extent to which life, liberty, and the pursuit of happiness of the individual members of society are involved in the struggle for power. More particularly, the crude methods of personal combat have been replaced by the refined instruments of social, commercial, and professional competition. The struggle for power is being fought, rather than with deadly weapons, with competitive examinations, with competition for social distinctions, with periodical elections for



### *Ethics, Mores, and Law as Restraints on Power*

public and private offices, and, above all, with competition for the possession of money and of things measurable in money.

In the domestic societies of Western civilization the possession of money has become the outstanding symbol of the possession of power. Through the competition for the acquisition of money the power aspirations of the individual find a civilized outlet in harmony with the rules of conduct laid down by society. The different normative injunctions against homicide and against individual and collective violence of any kind aim at creating the normative preconditions for such a civilized redirection of the struggle for power. All the social instrumentalities and institutions relevant to the different competitive devices of society serve the purpose, not of eliminating the struggle for power, but of creating civilized substitutes for the brutality and crudeness of an unlimited and unregulated struggle for power.

Such is, in brief and sketchy outline, the way in which ethics, mores, and law limit the struggle for power in the domestic societies of Western civilization. What can we say in this respect of international society? What rules of ethics, mores, and law are effective on the international scene? What functions do they fulfill for international society? What kind of international ethics, international mores in the form of world public opinion, and international law is there which would delimit, regulate, and civilize the struggle for power among nations in the same way as the domestic normative orders fulfill this function for the struggle for power among individuals belonging to the same domestic society?

## CHAPTER XIV

# *International Morality*

A discussion of international morality must guard against the two extremes either of overrating the influence of ethics upon international politics or else of denying that statesmen and diplomats are moved by anything else but considerations of material power.

On the one hand, there is the dual error of confounding the moral rules which people actually observe with those they pretend to observe as well as with those which writers declare they ought to observe. "On no subject of human interest, except theology," said Professor John Chipman Gray, "has there been so much loose writing and nebulous speculation as on international law."<sup>1</sup> The same must be said of international morality. Writers have put forward moral precepts which statesmen and diplomats ought to take to heart in order to make relations between nations more peaceful and less anarchic, such as the keeping of promises, trust in the other's word, fair dealing, respect for international law, protection of minorities, repudiation of war as an instrument of national policy. But they have rarely asked themselves whether and to what extent such precepts, however desirable in themselves, actually determine the actions of men. Furthermore, since statesmen and diplomats are wont to justify their actions and objectives in moral terms, regardless of their actual motives, it would be equally erroneous to take those protestations of selfless and peaceful intentions, of humanitarian purposes, and international ideals at their face value. It is pertinent to ask whether they are mere ideologies concealing the true motives of action or whether they express a genuine concern for the compliance of international policies with ethical standards.

On the other hand, there is the misconception, usually associated with the general depreciation and moral condemnation of power politics, discussed above,<sup>2</sup> that international politics is so thoroughly evil that it is no use looking for ethical limitations of the aspirations for power on the international scene. Yet, if we ask ourselves what statesmen and diplomats are capable of doing to further the power objectives of their respective nations and what they actually do, we realize that they do less than they probably could and less than they actually did in other periods of history. They refuse to consider certain ends and to use certain means, either altogether or under certain con-

<sup>1</sup> *Nature and Sources of the Law* (New York: The Macmillan Company, 1927), p. 127.

<sup>2</sup> See pp. 15 ff.

ditions, not because in the light of expediency they appear impractical or unwise, but because certain moral rules interpose an absolute barrier. Moral rules do not permit certain policies to be considered at all from the point of view of expediency. Such ethical inhibitions operate in our time on different levels with different effectiveness. Their restraining function is most obvious and most effective in affirming the sacredness of human life in times of peace.

## I. THE PROTECTION OF HUMAN LIFE

### *a) Protection of Human Life in Peace*

International politics can be defined, as we have seen, as a continuing effort to maintain and to increase the power of one's own nation and to keep in check or reduce the power of other nations. The relative power of nations depends, however, as we have also pointed out,<sup>3</sup> upon the quantity and quality of human beings in terms of size and quality of population, size and quality of military establishment, quality of government, and, more particularly, of diplomacy. Viewed as a series of technical tasks into which ethical considerations do not enter, international politics would have to consider as one of its legitimate tasks the drastic reduction or even the elimination of the population of a rival nation, of its most prominent military and political leaders, and of its ablest diplomats. And when international politics was considered exclusively as a technique, without ethical significance, for the purpose of maintaining and gaining power, such methods were used without moral scruples and as a matter of course.

According to its official records, the Republic of Venice, from 1415 to 1525, planned or attempted about two hundred assassinations for purposes of international politics. Among the prospective victims were two emperors, two kings of France, and three sultans. The documents record virtually no offer of assassination to have been rejected by the Venetian government. From 1456 to 1472, it accepted twenty offers to kill the Sultan Mahomet II, the main antagonist of Venice during that period. In 1514, John of Ragusa offered to poison anybody selected by the government of Venice for an annual salary of fifteen hundred ducats. The Venetian government hired the man "on trial," as we would say today, and asked him to show what he could do with Emperor Maximilian. In the same period the cardinals brought their own butlers and wine to a papal coronation dinner for fear they might otherwise be poisoned. This custom is reported to have been general in Rome without the host's taking offense at it.

Obviously, such methods to attain political ends are no longer practiced today. Yet the political motives for employing them exist today as they did when practices of this kind actually prevailed. It is not a matter of indifference for the nations engaged in the competition for power whether or not their competitor can avail itself of the services of outstanding military and political leaders. Thus they may hope that an outstanding leader or governing group

<sup>3</sup> See above, pp. 88 ff.

## *Politics among Nations*

will be compelled to give up the reins of power, either through a political upheaval or through infirmity and death. We know now that during the Second World War speculations as to how long Hitler and Mussolini would stay alive or at least in power formed an important part of the power calculations of the United Nations, and that the news of President Roosevelt's death revived Hitler's hopes in victory. While these lines are being written, one of the major factors in American policy toward the Soviet Union seems to be the expectation that the group governing the Soviet Union will be unable to keep itself in power. The technical difficulties of engineering such removals from power by violent means are not greater today than they were in previous periods of history. Rather the contrary is likely to be the case. Such removals are still as desirable and feasible as they always were. What has changed is the influence of civilization which makes some policies that are desirable and feasible ethically reprehensible and, hence, normally impossible of execution.

Ethical limitations of the same kind protect in times of peace the lives not only of outstanding individuals, but also of large groups, even of whole nations whose destruction would be both politically desirable and feasible. In the problem of Germany, as seen both by the Germans and by the rest of the world, modern history provides a striking illustration of the influence of ethics upon international politics. The fundamental fact of international politics from the German point of view has been from Bismarck to Hitler the "encirclement" of Germany by powerful nations in the East and in the West. Bismarck, however ruthless and immoral his particular moves on the chessboard of international politics may have been, rarely deviated from the basic rules of the game which had prevailed in the society of Christian princes of the eighteenth century. It was a fraudulent and treacherous game, but there were a few things which no member of that aristocratic society would stoop to do. Thus, confronted with the fundamental fact of Germany's political existence — the proximity of Russia and France — Bismarck accepted the inevitability of that fact and tried to turn it to Germany's advantage by maintaining close relations with Russia and by isolating France.

Hitler, on the other hand, did not recognize the social framework within whose limitations international politics had operated from the end of the Thirty Years' War virtually to his own ascent to power. He was free of the moral scruples which had compelled Bismarck to accept the existence of France and Russia as the inescapable fact upon which to build a German foreign policy. Hitler undertook to change that fact by destroying physically Germany's eastern and western neighbors. Considered as a mere problem of political technique devoid of ethical significance, Hitler's solution was much more thorough and politically expedient than Bismarck's; for it promised to solve the problem of Germany's international position once and for all as far as the eastern and western neighbors of Germany were concerned. Furthermore, in itself, Hitler's solution proved to be as feasible as it would have been in Bismarck's time. It might have succeeded had it not been for certain errors in over-all judgment, errors which the political genius of Bismarck might well have avoided.

The German problem, as it presents itself to the non-German world and

especially to the nations threatened with German hegemony, was formulated with brutal frankness by Clemenceau when he declared that there were twenty million Germans too many. This statement points to the inescapable fact, which has confronted Europe and the world since the Franco-German War of 1870, that Germany is by virtue of size and quality of population the most powerful nation of Europe. To reconcile this fact with the security of the other European nations and of the rest of the world is the task of political reconstruction which faced the world after the First World War and which confronts it again after the Second. That, since Clemenceau, the German problem has always been posed in terms which take the existence of "twenty million Germans too many" for granted reveals the same ethical limitations on the pursuit of power which we found in Bismarck's foreign policy and which we did not find in Hitler's. For there are two ways of dealing with a problem of international politics, such as the German.

One is the method by which the Romans irrevocably solved the Carthaginian problem. It is the method of solving a technical political problem by the appropriate means without regard for any transcendent ethical considerations. Since there were too many Carthaginians from the point of view of the power aspirations of Rome, Cato would end his every speech by proclaiming: "*Ceterum censeo Carthaginem esse delendam*" ("As for the rest, I am of the opinion that Carthage must be destroyed"). With its destruction the Carthaginian problem, as seen by Rome, was solved forever. No threat to Rome's security and ambition was ever again to rise from that desolate place that once was Carthage. Similarly, if the Germans had been successful in their over-all plans and if their concentration camps and extermination camps could have finished their tasks, the "nightmare of coalitions" would have been forever banished from the minds of German statesmen.

A foreign policy which does not admit mass extermination as a means to its end does not impose this limitation upon itself because of considerations of political expediency. On the contrary, expediency would counsel such a thorough and effective operation. The limitation derives from an absolute moral principle, the violation of which no consideration of national advantage can justify. A foreign policy of this kind, therefore, actually sacrifices the national interest where its consistent pursuit would necessitate the violation of an ethical principle, such as the prohibition of mass killing in times of peace. This point cannot be too strongly made; for frequently the opinion is advanced that this respect for human life is the outgrowth of "the obligation not to inflict *unnecessary* death or suffering on other human beings, i.e., death or suffering not necessary for the attainment of some higher purpose which is held, rightly or wrongly, to justify a derogation from the general obligation." <sup>4</sup> On the contrary, the fact of the matter is that nations recognize a moral obligation to refrain from the infliction of death and suffering under certain conditions despite the possibility of justifying such conduct in the light of a higher purpose, such as the national interest.

---

<sup>4</sup> E. H. Carr, *The Twenty Years' Crisis, 1919-39* (London: Macmillan and Company, 1939), p. 196.

## *Politics among Nations*

### *b) Protection of Human Life in War*

Similar ethical limitations are placed upon international policies in times of war. They concern civilians and combatants unable or unwilling to fight. From the beginning of history through the better part of the Middle Ages, belligerents were held to be free, according to ethics as well as law, to kill all enemies whether or not they were members of the armed forces, or else to treat them in any way they saw fit. Men, women, and children were often put to the sword or sold into slavery by the victor without any adverse moral reactions taking place. In chapter iv of Book III of *On the Law of War and Peace* under the heading "On the Right of Killing Enemies in a Public War and on Other Violence against the Person," Hugo Grotius presents an impressive catalogue of acts of violence committed in ancient history against enemy persons without discrimination. Grotius himself, writing in the third decade of the seventeenth century, still regarded most of them as justified in law and ethics, provided the war was waged for a just cause.<sup>6</sup>

This absence of moral restraints upon killing in war resulted from the nature of war itself. In those times war was considered a contest between all the inhabitants of the territories of the belligerent states. The enemy was less a state in the modern sense of a legal abstraction than all the individuals owing allegiance to a certain lord or living within a certain territory. Thus every individual citizen of the enemy state became an enemy of every individual citizen of the other side.

Since the end of the Thirty Years' War, the conception has become prevalent that war is not a contest between whole populations, but only between the armies of the belligerent states. In consequence, the distinction between combatants and noncombatants has become one of the fundamental legal and moral principles governing the actions of belligerents. War is considered to be a contest between the armed forces of the belligerent states, and, since the civilian populations do not participate actively in the armed contest, they are not to be made its object. Consequently, it is considered to be a moral and legal duty not to attack, wound, or kill noncombatant civilians purposely. Injuries and death suffered by them as incidents of military operations, such as the bombardment of a town or a battle taking place in an inhabited area, are regretted as sometimes unavoidable concomitants of war. However, to avoid them to the utmost is again considered a moral and legal duty. The Hague Conventions with respect to the Laws and Customs of War on Land of 1899 and 1907 gave express and virtually universal legal sanction to that principle.

A corresponding development has taken place with regard to members of the armed forces unwilling or unable to fight. It follows from the conception of war prevailing in antiquity and in the better part of the Middle Ages that no exception to the moral and legal right to kill all enemies could be made for certain categories of disabled combatants. Thus Grotius could still state as the prevailing moral and legal conviction of his time: "The right to inflict injury extends even over captives, and without limitation of time. . . . The right

---

<sup>6</sup> See especially § III.

to inflict injury extends even over those who wish to surrender, but whose surrender is not accepted.”<sup>6</sup>

Yet, as the logical outgrowth of the conception of war as a contest between armed forces, the idea developed that only those who are actually able and willing to participate actively in warfare ought to be the object of deliberate armed action. Those who were no longer engaged in actual warfare because of sickness, wounds, or because they had been made prisoners or were willing to be made prisoners ought not to be harmed. This tendency toward the humanization of warfare started in the sixteenth century and culminated in the great multilateral treaties of the nineteenth and early twentieth centuries. Practically all civilized nations have adhered to these treaties. Between 1581 and 1864, 291 international agreements were concluded for the purpose of protecting the lives of the wounded and sick. The Geneva Convention of 1864, superseded by those of 1906 and 1929, translated into concrete and detailed legal obligations the moral convictions of the age as to the treatment to be accorded to the wounded, the sick, and the medical persons in charge of them. The International Red Cross is both the symbol and the outstanding institutional realization of those moral convictions.

As concerns prisoners of war, their lot was still miserable even in the eighteenth century, although they were as a rule no longer killed, but were treated as criminals and used as objects of exploitation by being released only for ransom. Article 24 of the Treaty of Friendship, concluded in 1785 between the United States and Prussia, for the first time clearly indicated a change in the moral convictions on that matter. It prohibited the confinement of prisoners of war in convict prisons as well as the use of irons and stipulated their treatment as military personnel. The Hague Conventions of 1899 and 1907 as well as the Geneva Convention of 1929 laid down a detailed system of legal rules intended to assure humane treatment of prisoners of war.

From the same humanitarian concern with the life and sufferings of human beings exposed to the destructiveness of war emanate all the international treaties concluded since the mid-nineteenth century for the purpose of humanizing warfare. They prohibit the use of certain weapons, limit the use of others, define the rights and duties of neutrals—in short, they try to infuse into warfare a spirit of decency and of respect for the common humanity of all its prospective victims and to restrict violence to the minimum compatible with the goal of war, that is, breaking the enemy's will to resist. The Declaration of Paris of 1856 limited maritime warfare. The Declaration of St. Petersburg of 1868 prohibited the use of lightweight projectiles charged with explosives or inflammable substances. The Hague Declaration of 1899 prohibited the use of expanding (dumdum) bullets. A number of international conventions prohibited gas, chemical, and bacteriological warfare. The Hague Conventions of 1899 and 1907 codified the laws of war on land and sea and the rights and duties of neutrals. The London Protocol of 1936 limited the use of submarines against merchant vessels. And, in our times, attempts are being made to outlaw atomic warfare. All these efforts bear witness to the

---

<sup>6</sup> *Loc. cit.*, § X, XI.

## *Politics among Nations*

virtually universal growth of a moral reluctance to use violence without limitation as an instrument of international politics.

There may be legal arguments against the validity or effectiveness of these international treaties, derived from the wholesale disregard or violations of their prohibitions. Yet this is no argument against the existence of a moral conscience which feels ill at ease in the presence of violence or, at least, certain kinds of violence on the international scene. The existence of such a conscience is attested to, on the one hand, by the attempts to bring the practice of states into harmony with moral principles through international agreements. On the other hand, it reveals itself in the general justifications and excuses defending alleged violations of these agreements in moral terms. Legal agreements of this kind are universally adhered to and nations try to live up to them, at least in a certain measure. Therefore, the protestations of innocence or of moral justification by which accusations in such matters are uniformly met are more than mere ideologies. They are the indirect recognition of certain moral limitations which most nations frequently violate while feeling they ought not to violate them.

### *c) Moral Condemnation of War*

Finally, there is the attitude toward war itself which, since the turn of the century, has reflected an ever increasing awareness on the part of most statesmen of certain ethical limitations restricting the use of war as an instrument of international politics. Statesmen have decried the ravages of war and have justified their own participation in them in terms of self-defense or religious duty since the beginning of history. The avoidance of war itself, that is, of any war, has become an aim of statecraft only in the last half-century. The two Hague peace conferences of 1899 and 1907, the League of Nations of 1919, the Briand-Kellogg Pact of 1928 outlawing aggressive war, and the United Nations in our day—all have the avoidance of war as such as their ultimate objective.

At the foundation of these and other legal instruments and organizations, of which Part Six of this book will treat in detail, there is the conviction that war, and especially modern war, is not only a terrible thing to be avoided for reasons of expediency, but also an evil thing to be shunned on moral grounds. The student of the different collections of diplomatic documents concerning the origins of the First World War is struck by the hesitancy on the part of almost all responsible statesmen, with the exception perhaps of those of Vienna and St. Petersburg, to take steps which might irrevocably lead to war. This hesitancy and the almost general dismay among the statesmen when war finally proved to be inevitable contrasts sharply with the deliberate care with which, as late as the nineteenth century, wars were planned and incidents fabricated for the purpose of making war inevitable and placing the blame for starting it on the other side.

In the years preceding the Second World War the policies of the Western powers were animated, to their great political and military disadvantage, by the desire to avoid war at any price. This desire overrode all other considerations of national policy. It is especially in the refusal to consider seriously the



## *International Morality*

possibility of preventive war, regardless of its expediency from the point of view of the national interest, that the ethical condemnation of war as such has manifested itself in recent times in the Western world. When war comes, it must come as a natural catastrophe or as the evil deed of another nation, not as a foreseen and planned culmination of one's own foreign policy. Only thus might the moral scruples, rising from the violated ethical norm which holds that there ought to be no war at all, be stilled, if they can be stilled at all.

### *d) International Morality and Total War*

Thus in contrast to antiquity and the better part of the Middle Ages, the modern age places moral limitations upon the conduct of foreign affairs in so far as they might affect the lives of individuals or groups of individuals. There are, however, factors in the present condition of mankind which point toward a definite weakening of those moral limitations. Let us remember that the absence of moral limitations with regard to the destruction of life was concomitant with the total character of warfare in which whole populations faced each other as personal enemies. Let us remember, too, that the gradual limitation of killing in war to certain groups and its subjection to certain conditions coincided with the gradual development of limited war in which only armies faced each other as active opponents. With war taking on in recent times, to an ever greater degree and in different respects, a total character, the moral limitations upon killing are observed to an ever lessening degree. Indeed, their very existence in the consciences of political and military leaders as well as of the common people becomes ever more precarious and is threatened with extinction.

War in our time has become total in four different respects: (1) with regard to the fraction of the population engaged in activities essential for the conduct of the war, (2) with regard to the fraction of the population affected by the conduct of the war, (3) with respect to the fraction of the population completely identified in its convictions and emotions with the conduct of the war, and (4) with respect to the objective of the war.

Mass armies supported by the productive effort of the majority of the civilian population have replaced the relatively small armies of previous centuries which consumed only a small portion of the national product. The success of the civilian population in keeping the armed forces supplied may be as important for the outcome of the war as the military effort itself. Therefore, the defeat of the civilian population — the breaking of its ability and will to produce — may be as important as the defeat of the armed forces — the breaking of their ability and will to resist. Thus the character of modern war, drawing its weapons from a vast industrial machine, blurs the distinction between soldier and civilian. The industrial worker, the farmer, the railroad engineer, and the scientist are not innocent bystanders cheering on the armed forces from the sidelines. They are as intrinsic and indispensable a part of the military organization as the soldiers, sailors, and airmen. Thus a modern nation at war must wish to disrupt and destroy the productive processes of its enemy, and the modern technology of war provides the means for the realization of that desire. The importance of civilian production for

## *Politics among Nations*

modern war and the interest in injuring enemy production were already generally recognized in the First World War. Then, however, the technological means of affecting the civilian productive processes directly were only in their infancy. The belligerents had to resort to indirect means, such as blockades and submarine warfare. They attempted to interfere directly with civilian life through air attacks and long-range bombardment only sporadically and with indifferent results.

The Second World War has made the latter methods of direct interference the most effective instrument for the destruction of a nation's productive capacity. The interest in the mass destruction of civilian life and property coincided with the ability to carry such mass destruction through, and this combination has been too strong for the moral convictions of the modern world to resist. Voicing the moral convictions of the first decades of the century, Secretary of State Cordell Hull declared on June 11, 1938, with reference to the bombardment of Canton by Japan, that the administration disapproved of the sale of aircraft and aircraft armaments to countries which had engaged in the bombing of civilian populations. In his speech of December 2, 1939, President Roosevelt declared a similar moral embargo against the Soviet Union in view of its military operations against Finnish civilians. Only a few years later all belligerents engaged in practices of this kind on a scale dwarfing those which American statesmen had condemned on moral grounds. Warsaw and Rotterdam, London and Coventry, Cologne and Nuremberg, Hiroshima and Nagasaki are stepping-stones, not only in the development of the modern technology of war, but also in the development of the modern morality of warfare.

The national interest, as created by the character of modern war, and the possibility of satisfying that interest, as presented by the modern technology of warfare, have had a deteriorating effect upon the moral limitations of international policies. This deterioration is further accentuated by the emotional involvement of the great masses of the warring populations in modern war. As the religious wars of the latter sixteenth and of the first half of the seventeenth centuries were followed by the dynastic wars of the latter seventeenth and eighteenth centuries, and as the latter yielded to the national wars of the nineteenth and the early twentieth centuries, so war in our time tends to revert to the religious type by becoming ideological in character. The citizen of a modern warring nation, in contrast to his ancestors of the eighteenth and nineteenth centuries, does not fight for the glory of his prince or the unity and greatness of his nation, but for an "ideal," a set of "principles," a "way of life," for which he claims a monopoly of truth and virtue. In consequence, he fights to the death or to "unconditional surrender" all those who adhere to another, a false and evil, "ideal" and "way of life." Since it is the latter which he fights in whatever persons they manifest themselves, the distinctions between fighting and disabled soldiers, combatants and civilians—if they are not eliminated altogether—are subordinated to the one distinction which really matters: the distinction between the representatives of the right and the wrong philosophy and way of life. The moral duty to spare the wounded, the sick, the surrendering and unarmed enemy, and to respect him as a human being who was an enemy only by virtue of being found on the other side of the

## *International Morality*

fence, is superseded by the moral duty to punish and to wipe off the face of the earth the professors and practitioners of evil.

Under the impact of this fundamental change in the conception of warfare, not only were the moral limitations upon killing in war, to which we have referred above, extensively violated during the Second World War, but there has developed a tendency to justify on moral grounds the refusal to take prisoners, the killing of prisoners, and the indiscriminate killing of members of the armed forces and of civilians, and thus to assuage one's moral scruples, if not to shake them off altogether. Thus, while the moral limitations upon killing in times of peace in support of international policies remain intact today, the moral limitations upon killing in war have proved to be largely ineffective in our time. What is more important for the purposes of our present discussion, they have shown a tendency under the impact of a fundamentally altered conception of war to weaken and disappear altogether as rules of conduct.

More than half a century ago, in an era of general optimism, a great scholar clearly foresaw the possibility of this development and analyzed its elements. John Westlake, Whewell Professor of International Law at the University of Cambridge, wrote in 1894:

It is almost a truism to say that the mitigation of war must depend on the parties to it feeling that they belong to a larger whole than their respective tribes or states, a whole in which the enemy too is comprised, so that duties arising out of that larger citizenship are owed even to him. This sentiment has never been wholly wanting in Europe since the commencement of historical times, but there have been great variations in the nature and extent of the whole to which the wider attachment was felt. . . . In our own time there is a cosmopolitan sentiment, a belief in a commonwealth of mankind similar to that of the Stoics, but stronger because the soil has been prepared by Christianity, and by the mutual respect which great states tolerably equal in power and similar in civilization cannot help feeling for one another. . . . There have been periods during which the level has fallen, and one such period it belongs to our subject to notice. The wars of religion which followed the Reformation were among the most terrible in which the beast in man ever broke loose, and yet they occurred in an age of comparative enlightenment. Zeal for a cause, however worthy the cause may be, is one of the strongest and most dangerous irritants to which human passion is subject; and the tie of Protestant to Protestant and of Catholic to Catholic, cutting across the state tie instead of embracing it unweakened in a more comprehensive one, enfeebled the ordinary checks to passion when they were most wanted. Such a degradation of war would tend to recur if socialism attained to the consistency and power of a militant creed, and met the present idea of the state on the field of battle. It is possible that we might then see in war a license equal to that which anarchism shows us in peace!<sup>7</sup>

---

<sup>7</sup> *Chapters on the Principles of International Law* (Cambridge: At the University Press, 1894), pp. 267 ff.

## *Politics among Nations*

### 2. UNIVERSAL MORALITY VS. NATIONALISTIC UNIVERSALISM

The deterioration of moral limitations in international politics which has occurred in recent years with regard to the protection of life is only a special instance of a general and, for the purposes of this discussion, much more far-reaching dissolution of an ethical system which in the past imposed its restraints upon the day-by-day operations of the foreign office, but does so no longer. Two factors have brought about this dissolution: the substitution of democratic for aristocratic responsibility in foreign affairs and the substitution of nationalistic standards of action for universal ones.

#### *a) Personal Ethics of the Aristocratic International*

In the seventeenth and eighteenth centuries, and to a lessening degree up to the First World War, international morality was the concern of a personal sovereign, that is, an individually determined prince and his successors, and of a relatively small, cohesive, and homogeneous group of aristocratic rulers. The prince and the aristocratic rulers of a particular nation were in constant intimate contact with the princes and aristocratic rulers of other nations. They were joined together by family ties, a common language (which was French), common cultural values, a common style of life, and common moral convictions about what a gentleman was and was not allowed to do in his relations with another gentleman, whether of his own or of a foreign nation. The princes competing for power considered themselves to be competitors in a game whose rules were accepted by all the other competitors. The members of their diplomatic and military services looked upon themselves as employees who served their employer either by virtue of the accident of birth, reinforced often, but by no means always, by a sense of personal loyalty to the monarch, or because of the promise of pay, influence, and glory which he held out to them.

The desire for material gain especially provided for the members of this aristocratic society a common bond which was stronger than the ties of dynastic or national loyalty. Thus it was proper and common for a government to pay the foreign minister or diplomat of another country a pension. Lord Robert Cecil, the Minister of Elizabeth, received one from Spain. Sir Henry Wotton, British Ambassador to Venice in the seventeenth century, accepted one from Savoy while applying for one from Spain. The documents which the French revolutionary government published in 1793 show that France subsidized Austrian statesmen between 1757 and 1769 to the tune of 82,652,479 livres, with the Austrian Chancellor Kaunitz receiving 100,000. Nor was it regarded any less proper or less usual for a government to compensate foreign statesmen for their co-operation in the conclusion of treaties. In 1716, French Cardinal Dubois offered British Minister Stanhope 600,000 livres for an alliance with France. He reported that, while not accepting the proposition at that time, Stanhope "listened graciously without being displeased." After the conclusion of the Treaty of Basel of 1795, by which Prussia with-

drew from the war against France, Prussian Minister Hardenberg received from the French government valuables worth 30,000 francs and complained of the insignificance of the gift. In 1801, the Margrave of Baden spent 500,000 francs in the form of "diplomatic presents," of which French Foreign Minister Talleyrand received 150,000. It was originally intended to give him only 100,000, but the amount was increased after it had become known that he had received from Prussia a snuffbox worth 66,000 francs as well as 100,000 francs in cash.

The Prussian Ambassador in Paris summed up well the main rule of this game when he reported to his government in 1802: "Experience has taught everybody who is here on diplomatic business that one ought never to give anything before the deal is definitely closed, but it has also proved that the allurements of gain will often work wonders."

However much transactions of this kind were lacking in nobility, those participating in them could not be passionately devoted to the cause of the countries whose interests were in their care. Obviously they had loyalties besides and above the one to the country which employed them. Furthermore, the expectation of material gain at the conclusion of a treaty could not fail to act as a powerful incentive for coming speedily to an understanding with the other side. Stalemates, adjournments *sine die*, and long-drawn-out wars were not likely to find favor with statesmen who had a very personal stake in the conclusion of treaties. In these two respects the commercialization of statecraft in the seventeenth and eighteenth centuries was bound to blunt the edge of international controversies and confine the aspirations for power of individual nations within relatively narrow limits.

In that period of history the Austrian Ambassador to France felt more at home at the court of Versailles than among his own nonaristocratic compatriots. He had closer social and moral ties with the members of the French aristocracy and the other aristocratic members of the diplomatic corps than with the Austrians of humble origin. Consequently, the diplomatic and military personnel fluctuated to a not inconsiderable degree from one monarchical employer to another. It was not rare that a French diplomat or officer, for some reason of self-interest, would enter the services of the King of Prussia and would further the international objectives of Prussia, or fight in the Prussian Army, against France. During the eighteenth century there was, for instance, an enormous influx of Germans into all branches of the Russian government, many of whom were dismissed in a kind of purge and returned to their countries of origin.

In 1756, shortly before the outbreak of the Seven Years' War, Frederick the Great sent the Scottish Earl Marischall as his Ambassador to Spain in order to get information about the Spanish intentions. The Scottish Ambassador of Prussia had a friend in Spain, an Irishman by the name of Wall, who happened to be Spanish Foreign Minister and who told him what he wanted to know. The Scot transmitted this information to the British Prime Minister who, in turn, passed it on to the King of Prussia. As late as 1792, shortly before the outbreak of the War of the First Coalition against France, the French government offered the supreme command of the French forces to the Duke of Brunswick who, however, decided to accept an offer from the King of

## *Politics among Nations*

Prussia to lead the Prussian Army against France. As late as 1815, at the Congress of Vienna, Alexander I of Russia had as ministers and advisers in foreign affairs two Germans, one Greek, one Corsican, one Swiss, one Pole — and one Russian.

Bismarck's experience in 1862, on the occasion of his recall as Prussian Ambassador to Russia is significant for the persistence of this international cohesion of the aristocracy. When he expressed to the Czar his regret at the necessity of leaving St. Petersburg, the Czar, misunderstanding this remark, asked Bismarck whether he was inclined to enter the Russian diplomatic service. Bismarck reported in his memoirs that he declined the offer "courteously."<sup>8</sup> What is important and significant for the purposes of our discussion is not that Bismarck declined the offer — many such offers have certainly been declined before and perhaps a few even after — but that he did so "courteously," and that even his report, written more than thirty years after the event, showed no trace of moral indignation. Only half a century ago the offer to an ambassador, who had just been appointed prime minister, to transfer his loyalties from one country to another was considered by the recipient as a sort of business proposition which did not at all insinuate the violation of moral standards.

Let us imagine that a similar offer were being made in our time by Mr. Stalin to the American Ambassador or by the American President to any diplomat accredited in Washington, and let us visualize the private embarrassment of the individual concerned and the public indignation following the incident, and we have the measure of the profundity of the change which has transformed the ethics of international politics in recent times. Today such an offer would be regarded as an invitation to treason, that is, the violation of the most fundamental of all moral obligations in international affairs; loyalty to one's own country. When it was made and even when it was reported shortly before the close of the nineteenth century, it was a proposition to be accepted or rejected on its merits without any lack of moral propriety attaching to it.

The moral standards of conduct with which the international aristocracy complied were of necessity of a supranational character. They applied not to all Prussians, Austrians, or Frenchmen, but to all men who by virtue of their birth and education were able to comprehend them and to act in accordance with them. It was in the concept and the rules of natural law that this cosmopolitan society found the source of its precepts of morality. The individual members of this society, therefore, felt themselves to be personally responsible for compliance with those moral rules of conduct; for it was to them as rational human beings, as individuals, that this moral code was addressed. When it was suggested to Louis XV that he counterfeit the bills of the Bank of England, the King rejected such a proposition which "could be considered here only with all the indignation and all the horror which it deserves." When a similar proposition was made in 1792 with respect to the French currency in order to save Louis XVI, the Austrian Emperor Francis II declared that "such an infamous project is not to be accepted."

---

<sup>8</sup> *Loc. cit.*, I, 341.

## *International Morality*

This sense of a highly personal moral obligation to be met by those in charge of foreign affairs with regard to their colleagues in other countries explains the emphasis with which the writers of the seventeenth and eighteenth centuries counseled the monarch to safeguard his "honor" and his "reputation" as his most precious possessions. Any action which Louis XV undertook on the international scene was his personal act in which his personal sense of moral obligation revealed itself and in which, therefore, his personal honor was engaged. A violation of his moral obligations, as they were recognized by his fellow-monarchs for themselves, would call into action not only his conscience, but also the spontaneous reactions of the supranational aristocratic society which would make him pay for the violation of its mores with a loss of prestige, that is, a loss of power.

### *b) Destruction of International Morality*

When in the course of the nineteenth century democratic selection and responsibility of government officials replaced government by the aristocracy, the structure of international society and, with it, of international morality underwent a fundamental change. Until virtually the end of the nineteenth century, aristocratic rulers were responsible for the conduct of foreign affairs in most countries. In the new age their place has been taken by officials elected or appointed regardless of class distinctions. These officials are legally and morally responsible for their official acts not to a monarch, that is, a specific individual, but to a collectivity, that is, a parliamentary majority, or the people as a whole. An important shift in public opinion may easily call for a change in the personnel making foreign policy. They will be replaced by another group of individuals taken from whatever group of the population prevails at the moment.

Government officials are no longer exclusively recruited from aristocratic groups, but from virtually the whole population. The present American Secretary of State is a former general. The French Foreign Minister is a former college professor. The former General Secretary of the Transport and General Workers Union has taken the place of the British Secretary of State for Foreign Affairs. A former professional revolutionary is responsible for Russian foreign policy.

In countries such as Great Britain, France, or Italy, where the government needs the support of a majority of parliament for its continuation in office, any change in the parliamentary majority necessitates a change in the composition of the government. Even in a country such as the United States, where not Congress, but only general elections can put an administration into office or remove it, the turnover of the policy-makers in the State Department is considerably enough. Within eighteen months, from July 1945, to January 1947, the United States has had three secretaries of state. Of all the policy-making officials of the State Department, that is, the under-secretary and the assistant secretaries, who held office in October 1945, none was still in office two years later. The fluctuation of the policy-makers in international affairs and their responsibility to an indefinite collective entity has far-reaching con-

## *Politics among Nations*

sequences for the effectiveness, nay, for the very existence of an international moral order.

This transformation within the individual nations changed international morality as a system of moral restraints from a reality into a mere figure of speech. When we say that George III of England was subject to certain moral restraints in his dealings with Louis XVI of France or Catharine the Great of Russia, we are referring to something real, something which can be identified with the conscience and the actions of certain specific individuals. When we say that the British Commonwealth of Nations or even Great Britain alone has moral obligations toward the United States or France, we are making use of a fiction. By virtue of this fiction international law deals with nations as though they were individual persons, but nothing in the sphere of moral obligations corresponds to this legal concept. Whatever the conscience of George VI as the constitutional head of the British Commonwealth and of Great Britain demands of the conduct of the foreign affairs of Great Britain and of the Commonwealth is irrelevant for the actual conduct of those affairs; for George VI is not responsible for those affairs and has no actual influence upon them. What of the Prime Ministers, and the Secretaries of State for Foreign Affairs of Great Britain and of the Dominions? They are but members of the cabinet, which as a collective body determines foreign policy, as any other policy, by majority decision. The cabinet as a whole is politically responsible to the majority party whose political preferences it is supposed to translate into political action. It is legally responsible to Parliament of which it is, constitutionally speaking, only a committee. Parliament, however, is responsible to the electorate from which it has received the mandate to govern and from which its individual members hope to receive another mandate at the next general election.

The individual members of the electorate, finally, may have no moral convictions of a supranational character at all which determine their actions on election day and in between, or, if they have such convictions, they will be most heterogeneous in content. In other words, there will be those who act according to the moral maxim, "Right or wrong—my country." There will be those who apply to their own actions with regard to international affairs as well as to the actions of the government the standard of Christian ethics. There will be those who apply the standard of the United Nations or of world government or of humanitarian ethics. The fluctuating members of the policy-making group or of the permanent bureaucracy of the Foreign Office may or may not reflect these and similar divisions of opinion. In any case, the reference to a moral rule of conduct requires an individual conscience from which it emanates, and there is no individual conscience from which what we call the international morality of Great Britain or of any other nation could emanate.

An individual statesman may follow the dictates of his own conscience with regard to international affairs. If he does, it is to him as an individual that these moral convictions are attributed and not to the nation to which he belongs and in whose name he may even actually speak. Thus, when Lord Morley and John Burns felt that the participation of Great Britain in the First World War was incompatible with their moral convictions, they resigned



from the British cabinet. This was their personal act and those were their personal convictions. When at the same moment the German Chancellor admitted as head of the German government the illegality and immorality of the violation of Belgium's neutrality, justified only by a state of necessity, he spoke for himself only. The voice of his conscience could not be and was not identified with the conscience of the collectivity called Germany. The moral principles which guided Laval as French Minister of Foreign Affairs and Prime Minister were his, not those of France, and nobody pretended the latter to be the case.

Moral rules have their seat in the consciences of individual men. Government by clearly identifiable men, who can be held personally accountable for their acts, is, therefore, the precondition for the existence of an effective system of international ethics. Where responsibility for government is widely distributed among a great number of individuals with different conceptions as to what is morally required in international affairs, or with no such conceptions at all, international morality as an effective system of restraints upon international policy becomes impossible. It is for this reason that Dean Roscoe Pound could say as far back as 1923: "It might be maintained plausibly, that a moral . . . order among states, was nearer attainment in the middle of the eighteenth century than it is today."<sup>9</sup>

### *c) Destruction of International Society*

While the democratic selection and responsibility of government officials destroyed international morality as an effective system of restraints, nationalism destroyed the international society itself within which that morality had operated. The French Revolution of 1789 marks the beginning of the new epoch of history which witnesses the gradual decline of the cosmopolitan aristocratic society and of the restraining influence of its morality upon international politics. Says Professor G. P. Gooch:

While patriotism is as old as the instinct of human association, nationalism as an articulate creed issued from the volcanic fires of the French Revolution. The tide of battle turned at Valmy; and on the evening after the skirmish Goethe . . . replied to a request for his opinion in the historic words, "From to-day begins a new era, and you will be able to say that you were present at its birth."<sup>10</sup>

It was a slow process of corrosion with the old order resisting valiantly, as illustrated by the Holy Alliance and incidents such as the one discussed above when as late as 1862 the Russian Czar invited Bismarck to enter the Russian diplomatic service.<sup>11</sup> Yet the decline of the international society and its morality, which had united the monarchs and the nobility of Christendom, is unmistakable toward the end of the nineteenth century. It has nowhere become more painfully patent than in the theatrical hollowness of William II's

<sup>9</sup> *Philosophical Theory and International Law, Bibliotheca Visseriana* (Leyden, 1923), I, 74.

<sup>10</sup> *Studies in Diplomacy and Statecraft* (London, New York, Toronto: Longmans, Green and Company, 1942), pp. 300, 301.

<sup>11</sup> See above, p. 186.

## *Politics among Nations*

verbal attempts at reviving it. He wrote to the Russian Czar in 1895, with regard to the French:

The Republicans are revolutionists *de natura*. The blood of Their Majesties is still on that country. Has it since then ever been happy or quiet again? Has it not staggered from bloodshed to bloodshed? Nicky, take my word on it, the curse of God has stricken that people forever. We Christian Kings and Emperors have one holy duty imposed on us by Heaven, that is to uphold the principle of By the Grace of God.

And the anachronism of William II's still-born plan, conceived on the eve of the Spanish-American War, to unite the European powers in support of the Spanish monarchy against the American republic, dismayed his advisers.

But even in 1914, on the eve of the First World War, there is in many of the statements and dispatches of statesmen and diplomats a melancholy undertone of regret that individuals who had so much in common should now be compelled to separate and identify themselves with the warring groups on the different sides of the frontiers. This, however, was only a feeble reminiscence which no longer had the power to influence the actions of men. By then, these men had naturally less in common with each other than they had with the respective peoples from which they had risen to the heights of power and whose will and interests they represented in their relations with other nations. What separated the French Foreign Minister from his opposite number in Berlin was much more important than what united them. Conversely, what united the French Foreign Minister with the French nation was much more important than anything which might set him apart from it. The place of the one international society to which all members of the different governing groups belonged and which provided a common framework for the different national societies had been taken by the national societies themselves. The national societies now gave to their representatives on the international scene the standards of conduct which the international society had formerly supplied.

When, in the course of the nineteenth century, this fragmentation of the aristocratic international society into its national segments was well on its way to consummation, the protagonists of nationalism were convinced that this development would strengthen the bonds of international morality rather than weaken them. For they believed that, once the national aspirations of the liberated peoples were satisfied and aristocratic rule replaced by popular government, nothing could divide the nations of the earth. Conscious of being members of the same humanity and inspired by the same ideals of freedom, tolerance, and peace, they would pursue their national destinies in harmony. Actually the spirit of nationalism, once it had materialized in national states, proved to be not universalistic and humanitarian, but particularistic and exclusive. When the international society of the seventeenth and eighteenth centuries was destroyed, it became obvious that there was nothing to take the place of that unifying and restraining element which had been a real society superimposed upon the particular national societies. The international solidarity of the working class under the banner of socialism proved to be an illusion. Organized religion tended to identify itself with

## *International Morality*

the national state rather than to transcend it. Thus the nation became the ultimate point of reference for the allegiance of the individual, and the members of the different nations all had their own particular object of allegiance.

We have in Lord Keynes's portrait of Clemenceau a vivid sketch of this new morality of nationalism:

He felt about France what Pericles felt of Athens — unique value in her, nothing else mattering. . . . He had one illusion — France; and one disillusion — mankind, including Frenchmen, and his colleagues not least. . . . Nations are real things, of whom you love one and feel for the rest indifference — or hatred. The glory of the nation you love is a desirable end — but generally to be obtained at your neighbor's expense. Prudence required some measure of lip-service to the "ideals" of foolish Americans and hypocritical Englishmen, but it would be stupid to believe that there is much room in the world, as it really is, for such affairs as the League of Nations, or any sense in the principle of self-determination except as an ingenious formula for rearranging the balance of power in one's own interests.<sup>12</sup>

This fragmentation of a formerly cohesive international society into a multiplicity of morally self-sufficient national communities, which have ceased to operate within a common framework of moral precepts, is but the outward symptom of the profound change which in recent times has transformed the relations between universal moral precepts and the particular systems of national ethics. The transformation has proceeded in two different ways. It has weakened, to the point of ineffectiveness, the universal, supranational moral rules of conduct, which before the age of nationalism had imposed a system — however precarious and wide-meshed — of limitations upon the international policies of individual nations, and it has finally endowed, in the minds and aspirations of individual nations, their particular national systems of ethics with universal validity.

### *d) Victory of Nationalism over Internationalism*

The crucial test of the vitality of a moral system occurs when its control of the consciences and actions of men is challenged by another system of morality. Thus the relative strength of the ethics of humility and self-denial of the Sermon on the Mount and of the ethics of self-advancement and power of modern Western society is determined by the extent to which either system of morality is able to mold the actions or at least the consciences of men in accordance with its precepts. Every human being, in so far as he is responsive to ethical appeals at all, is from time to time confronted with such a conflict of conscience, which tests the relative strength of conflicting moral commands. A similar test must determine the respective strength, with regard to the conduct of foreign affairs, of the supranational ethics and the ethics of nationalism. To the supranational ethics, composed of Christian, cosmopolitan, and humanitarian elements, the diplomatic language of the time pays its tribute and many individual writers postulate it. But the ethics of nationalism have been on the ascendancy throughout the world for the last century and a half.

---

<sup>12</sup> *The Economic Consequences of the Peace* (New York: Harcourt, Brace and Company, 1920), pp. 32, 33.

## *Politics among Nations*

Now it is indeed true that national ethics, as formulated in the philosophy of reason of state of the seventeenth and eighteenth centuries or in the concept of the national interest of the nineteenth and twentieth, has in most conflict situations proved itself to be superior to universal moral rules of conduct. This is obvious from a consideration of the most elemental and also the most important conflict situation of this kind, the one between the universal ethical precept, "Thou shalt not kill," and the command of a particular national ethics. "Thou shalt kill under certain conditions the enemies of thy country." The individual to whom these two moral rules of conduct are addressed is confronted with a conflict between his allegiance to humanity as a whole, manifesting itself in the respect for human life as such, irrespective of nationality or any other particular characteristic, and his loyalty to a particular nation whose interests he is called upon to promote at the price of the lives of the members of another nation. Most individuals today and during all of modern history have resolved this conflict in favor of loyalty to the nation. In this respect, however, three factors distinguish the present age from previous ones.

First, there is the enormously increased ability of the nation-state to exert moral compulsion upon its members. This ability is the result partly of the almost divine prestige which the nation enjoys in our time, partly of the control over the instruments molding public opinion which economic and technological developments have put at the disposal of the state.

Second, there is the extent to which loyalty to the nation requires the individual to disregard universal moral rules of conduct. The modern technology of war has given the individual opportunities for mass destruction unknown to previous ages. Today a nation may ask one single individual to destroy the lives of hundreds of thousands of people by dropping one atomic bomb. The compliance with a demand of such enormous consequences demonstrates the weakness of supranational ethics more impressively than the limited violations of universal standards, committed in pre-atomic times, were able to.

Finally, there is today, in consequence of the two other factors, much less chance for the individual to be loyal to supranational ethics when they are in conflict with the moral demands of the nation. The individual, faced with the enormity of the deeds which he is asked to commit in the name of the nation, and with the overwhelming weight of moral pressure which the nation exerts upon him, would require almost superhuman moral strength to resist those demands. The magnitude of the infractions of universal ethics committed on behalf of the nation and of the moral compulsion exerted in favor of them affects the qualitative relationship of the two systems of ethics. It puts in bold relief the desperate weakness of universal ethics in its conflict with the morality of the nation and decides the conflict in favor of the nation before it has really started.

### *c) Transformation of Nationalism*

It is at this point that this hopeless impotence of universal ethics becomes an important factor in bringing about a significant and far-reaching change in

## *International Morality*

the relations between supranational and national systems of morality. It is one of the factors which lead to the identification of both.<sup>18</sup> The individual comes to realize that the flouting of universal standards of morality is not the handiwork of a few wicked men, but the inevitable outgrowth of the conditions under which nations exist and pursue their aims. He experiences in his own conscience the feebleness of universal standards and the preponderance of national ethics as forces motivating the actions of men on the international scene, and his conscience does not cease being ill at ease.

Although the continuous discomfort of a perpetually uneasy conscience is too much for him to bear, he is too strongly attached to the concept of universal ethics to give it up altogether. Thus he identifies the morality of his own nation with the commands of supranational ethics. He pours, as it were, the contents of his national morality into the now almost empty bottle of universal ethics. So each nation comes to know again a universal morality, that is, its own national morality, which is taken to be the one which all the other nations ought to accept as their own. Instead of the universality of an ethics to which all nations adhere, we end up with the particularity of national ethics which claims the right to, and aspires toward, universal recognition. There are then as many ethical codes claiming universality as there are politically active nations.

Nations no longer oppose each other, as they did from the Treaty of Westphalia to the Napoleonic Wars and then again from the end of the latter to the First World War, within a framework of shared beliefs and common values, which imposes effective limitations upon the ends and means of their struggle for power. They oppose each other now as the standard-bearers of ethical systems, each of them of national origin and each of them claiming and aspiring to provide a supranational framework of moral standards which all the other nations ought to accept and within which their international policies ought to operate. The moral code of one nation flings the challenge of its universal claim into the face of another which reciprocates in kind. Compromise, the virtue of the old diplomacy, becomes the treason of the new; for the mutual accommodation of conflicting claims, possible or legitimate within a common framework of moral standards, amounts to surrender when the moral standards themselves are the stakes of the conflict. Thus the stage is set for a contest among nations whose stakes are no longer their relative positions within a political and moral system accepted by all, but the ability to impose upon the other contestants a new universal political and moral system recreated in the image of the victorious nation's political and moral convictions.

The first inkling of this development from one genuinely universal to a multiplicity of particular moral systems claiming, and competing for, universality can be detected in the contest between Napoleon and the nations allied against him. On both sides the contest was fought in the name of particular principles claiming universal validity: here the principles of the French Revolution, there the principle of legitimacy. However, with the defeat of Napoleon and the failure of the Holy Alliance to uphold its principles in

---

<sup>18</sup> For other factors, see below, pp. 304, 305.

## *Politics among Nations*

competition with the rising movement of nationalism, this attempt at erecting a particular code of ethics into a universal one came to an end and thus remained a mere historic interlude.

The present period of history in which generally and, as it seems, permanently universal moral rules of conduct are replaced by particular ones claiming universality was ushered in by Woodrow Wilson's war "to make the world safe for democracy." It is not by accident and it has deep significance that those who shared Wilson's philosophy called that war also a "crusade" for democracy. The First World War, as seen from Wilson's perspective, has indeed this in common with the Crusades of the Middle Ages: it was waged for the purpose of making one moral system, held by one group, prevail in the rest of the world. A few months after the democratic crusade had gotten under way, in October 1917, the foundations were laid in Russia for another moral and political structure which on its part, while accepted only by a fraction of humanity, was claimed to provide the common roof under which all humankind would eventually live together in justice and in peace. While, in the twenties, this latter claim was supported by insufficient power and, hence, was little more than a theoretical postulate, democratic universalism retired from the scene of active politics and isolationism took its place. It was only in the theoretical challenge which the priests of the new Marxian universalism flung in the face of the democratic world and in the moral, political, and economic ostracism with which the latter met the challenge that the conflict between the two universalisms made itself felt at that time in the field of international politics.

In the thirties the philosophy of nazism, grown in the soil of a particular nation, proclaimed itself the new moral code which would replace the vicious creed of bolshevism and the decadent morality of democracy and would impose itself upon mankind. The Second World War, viewed in the light of our present discussion, tested in the form of an armed conflict the validity of this claim of nazism to universality, and nazism lost the test. Yet, in the minds of many on the side of the United Nations, the principles of the Atlantic Charter and of the Declaration of Yalta made the Second World War also a contest for universal democracy, and democracy, too, lost the test. With the termination of the Second World War the two remaining moral and political systems claiming universal validity, democracy and communism, entered into active competition for the dominion of the world, and that is the situation in which we find ourselves today.

It would be the most dangerous of illusions to overlook or even to belittle the depth of the difference which exists between that situation and the condition of the modern state system from the end of the religious wars to the entrance of the United States into the First World War. One needs only to pick at random any conflict which occurred in that latter period, with the exception of the Napoleonic Wars, and compare it with the conflicts which have torn the world apart in the last three decades in order to realize the importance of that difference.

Let us compare with the international issues of our time the issues which brought France and the Hapsburgs into almost continual conflict from the beginning of the sixteenth to the middle of the eighteenth century, or which

pitted Great Britain and Prussia against France in the eighteenth century. These issues were territorial aggrandizement and dynastic competition. What was then at stake was an increase or decrease of glory, wealth, and power. Neither the Austrian nor the British nor the French nor the Prussian "way of life," that is, their system of beliefs and ethical convictions, was at stake. This is exactly what is at stake today. In the seventeenth and eighteenth centuries, none of the contestants on the international scene aspired to impose its own particular system of ethics, provided it had one, upon the others. The very possibility of such an aspiration never occurred to them, since they were aware only of one universal moral code to which they all gave unquestioning allegiance.

That common "system of arts, and laws, and manners," "the same level of politeness and cultivation," and the "sense of honour and justice," which Gibbon had detected in "the general manners of the times" and which for Fénelon, Rousseau, and Vattel were a lived and living reality,<sup>14</sup> have today in the main become a historic reminiscence, lingering on in learned treatises, utopian tracts, and diplomatic documents, but no longer capable of moving men to action. Only shreds and fragments survive of this system of supranational ethics which exerts its restraining influence upon international politics, as we have seen, only in isolated instances, such as killing in peacetime and preventive war. As for the influence of that system of supranational ethics upon the conscience of the actors on the international scene, it is rather like the feeble rays, barely visible above the horizon of consciousness, of a sun which has already set. Since the First World War, with ever increasing intensity and generality, each of the contestants in the international arena claims in its "way of life" to possess the whole truth of morality and politics which the others may reject only at their peril. With fierce exclusiveness all contestants equate their national conceptions of morality with what all mankind must and will ultimately accept and live by. In this, the ethics of international politics reverts to the politics and morality of tribalism, of the Crusades, and of the religious wars.<sup>15</sup>

However much the content and objectives of today's ethics of nationalistic universalism may differ from those of primitive tribes or of the Thirty Years' War, they do not differ in the function which they fulfill for international politics, and in the moral climate which they create. The morality of the particular group, far from limiting the struggle for power on the international

<sup>14</sup> See the references above, pp. 160, 161.

<sup>15</sup> To what extent the profession of universalistic principles of morality can go hand in hand with utter depravity in action is clearly demonstrated in the case of Timur, the Mongol would-be conqueror of the world, who in the fourteenth century conquered and destroyed Southern Asia and Asia Minor. After having killed hundreds of thousands of people — on December 12, 1398, he massacred 100,000 Hindu prisoners before Delhi — for the glory of God and of Mohammedanism, he said to a representative of conquered Aleppo: "I am not a man of blood; and God is my witness that in all my wars I have never been the aggressor, and that my enemies have always been the authors of their own calamity."

Gibbon, who reports this statement, adds: "During this peaceful conversation the streets of Aleppo streamed with blood, and re-echoed with the cries of mothers and children, with the shrieks of violated virgins. The rich plunder that was abandoned to his soldiers might stimulate their avarice; but their cruelty was enforced by the peremptory command of producing an adequate number of heads, which, according to his custom, were curiously piled in columns and pyramids. . . ." *The Decline and Fall of the Roman Empire* (Modern Library Edition), II, 1243.

## *Politics among Nations*

scene, gives that struggle a ferociousness and intensity not known to other ages. For the claim to universality which inspires the moral code of one particular group is incompatible with the identical claim of another group; the world has room for only one, and the other must yield or be destroyed. Thus, carrying their idols before them, the nationalistic masses of our time meet in the international arena, each group convinced that it executes the mandate of history, that it does for humanity what it seems to do for itself, and that it fulfills a sacred mission ordained by providence, however defined.

Little do they know that they meet under an empty sky from which the gods have departed.



## CHAPTER XV

# *World Public Opinion*

Little need be said about world public opinion which is not already implicit in the discussion of the preceding chapter. Yet the warning with which we started the discussion of international morality must here be repeated with special emphasis. We are here concerned with the actuality of world public opinion. We want to know of what it consists, how it manifests itself, what functions it fulfills in the field of international politics, and, more particularly, in what ways it imposes restraints upon the struggle for power on the international scene. There is, however, hardly a concept in the modern literature of international affairs which, in the last three decades, has been employed by statesmen and writers with greater effusiveness and less analytical precision than the concept of world public opinion.

World public opinion was supposed to be the foundation for the League of Nations. It was to be the enforcement agency for the Briand-Kellogg Pact, the decisions of the Permanent Court of International Justice, and international law in general. "The great weapon we rely upon," declared Lord Robert Cecil in the House of Commons on July 21, 1919, "is public opinion . . . and if we are wrong about it, then the whole thing is wrong."<sup>1</sup> As late as April 17, 1939, less than five months before the outbreak of the Second World War, Cordell Hull, then American Secretary of State, maintained that "a public opinion, the most potent of all forces for peace, is more strongly developing throughout the world."<sup>2</sup> Today we hear that world public opinion will use the United Nations as its instrument, or vice versa. *Life*, in an editorial "United Nations: A Balance Sheet," says that "The Charter relies heavily on a well-informed world opinion. The concept of U.N. as a forum, where international differences can be aired in public and judged by the public, has been thoroughly validated by events."<sup>3</sup> The General Assembly of the United Nations, in particular, is declared to be "the open conscience of the world."<sup>4</sup> In a report published in 1947 under the title *Security under the United Nations* the Commission to Study the Organization of Peace declares:

<sup>1</sup> *The Parliamentary Debates: Official Report. Fifth Series. Vol. 118. House of Commons, p. 992.*

<sup>2</sup> *New York Times*, April 18, 1939, p. 2.

<sup>3</sup> September 15, 1947, p. 40.

<sup>4</sup> Leland M. Goodrich and Edward Hambro, *Charter of the United Nations* (Boston: World Peace Foundation, 1946), p. 95.

## *Politics among Nations*

"We appeal for a world public opinion in support of the United Nations." Yet the *New York Times* goes so far as to state as a matter of fact that the Assembly of the United Nations "has considerable reserve powers under the Charter . . . at least to the extent of mobilizing world opinion, which, in the last analysis, determines the international balance of power."<sup>5</sup>

Two all-important questions must be answered before the possible meaning of these and innumerable similar assertions and appeals can be ascertained: What do we mean when we speak of world public opinion, and how does this world public opinion manifest itself under the moral and social conditions of the mid-twentieth century?

World public opinion is obviously a public opinion which transcends national boundaries and which unites members of different nations in a consensus with regard to at least certain fundamental international issues. This consensus makes itself felt in spontaneous reactions throughout the world against whatever move on the chessboard of international politics is disapproved by that consensus. Whenever the government of any nation proclaims a certain policy or takes a certain action on the international scene, which contravenes the opinion of mankind, humanity will rise regardless of national affiliations and at least try to impose its will through spontaneous sanctions upon the recalcitrant government. The latter, then, finds itself in about the same position as an individual or a group of individuals who have violated the mores of their national society or of one of its subdivisions and are by society's pressure either compelled to conform with its standards or be ostracized.

If such is the meaning of the common references to world public opinion, does such a world public opinion exist at present and does it exert a restraining influence upon the international policies of national governments? The answer is bound to be in the negative. Modern history has not recorded one instance of a government having been deterred from a certain international policy by the spontaneous reaction of a supranational public opinion. There have been attempts in recent history at mobilizing world public opinion against the foreign policy of a certain government — the Japanese aggressions against China since 1931, the German foreign policies since 1935, the Italian attack against Ethiopia in 1936. Yet, even if one supposed for the sake of argument that these attempts were successful in a certain measure and that a world public opinion actually existed in those instances, it certainly had no restraining effect upon the policies it opposed. But the supposition itself, as we shall see, is not supported by facts.

The reason why an affirmative answer is being given so often to these questions is to be found in the misinterpretation of two factors which, actually present in the international situation, point to the possible development of a world public opinion, and in the neglect of a third one which at present makes such a development impossible. The two factors from which the mistaken belief in the existence of a world public opinion originates are the common experience of certain psychological traits and elemental aspirations which unite all mankind, and the technological unification of the world. What has

---

<sup>5</sup> November 15, 1947, p. 16.

been neglected is the fact that everywhere in the world public opinion with regard to international affairs is molded by the agencies of national policies. These agencies, as pointed out previously,<sup>6</sup> claim for their national conceptions of morality supranational, that is, universal recognition.

## I. PSYCHOLOGICAL UNITY OF THE WORLD

There is at the bottom of all political contentions and conflicts an irreducible minimum of psychological traits and aspirations which are the common possession of all mankind. All human beings want to live and, hence, want the things which are necessary for life. All human beings want to be free and, hence, want to have those opportunities for self-expression and self-development which their particular culture considers to be desirable. All human beings seek power and, hence, seek social distinctions, again varying with the particular pattern of their culture, which put them ahead of and above their fellow men.

Upon this psychological foundation, the same for all men, rises an edifice of philosophical convictions, ethical postulates, and political aspirations. These, too, might be shared by all men under certain conditions, but actually they are not. They might be shared by all if the conditions under which men can satisfy their desire to live, to be free, and to have power, were similar all over the world, and if the conditions under which such satisfaction is withheld and must be striven for, were also similar everywhere. If this were so, the experience, common to all men, of what men seek, of what they are able to obtain, of what they are denied, and of what they must struggle for would indeed create a community of convictions, postulates, and aspirations, which would provide the common standards of evaluation for world public opinion. Any violation of the standards of this world public opinion, against and by whomsoever committed, would call forth spontaneous reactions on the part of humanity; for, in view of the hypothetical similarity of all conditions, all men would fear that what happens to one group might happen to any group.

Actually, however, reality does not correspond to our assumption of similarity of conditions throughout the world. The variations in the standard of living range from mass starvation to abundance; the variations in freedom, from tyranny to democracy, from economic slavery to equality; the variations in power, from extreme inequalities and unbridled one-man rule to wide distribution of power subject to constitutional limitations. This nation enjoys freedom, yet starves; that nation is well fed, but longs for freedom; still another enjoys security of life and individual freedom, but smarts under the rule of an autocratic government. In consequence, while philosophically the similarities of standards are considerable throughout the world — most political philosophies agree in their evaluation of the common good, of law, peace, and order, of life, liberty, and the pursuit of happiness — moral judgments and political evaluations show wide divergencies. The same moral and political concepts take on different meanings in different environments. Justice and

---

<sup>6</sup> See above, pp. 193 ff.

## *Politics among Nations*

democracy come to mean one thing here, something quite different there. A move on the international scene decried by one group as immoral and unjust is praised by another as the opposite. Thus the contrast between the community of psychological traits and elemental aspirations, on the one hand, and the absence of shared experiences, universal moral convictions, and common political aspirations, on the other, far from providing evidence for the existence of a world public opinion, rather demonstrates its impossibility, as humanity is constituted in our age.

### 2. AMBIGUITY OF TECHNOLOGICAL UNIFICATION

That same age, however, has provided a phenomenon which seems to have brought a world public opinion close to realization, if it has not actually created it—the technological unification of the world. When we say that this is “One World,” we mean not only that the modern development of communications has virtually obliterated geographical distances with regard to physical contacts and exchange of information and ideas among the members of the human race. We mean also that this virtually unlimited opportunity for physical and intellectual communication has created that community of experience embracing all humanity, from which a world public opinion can grow. Yet that conclusion is not borne out by the facts. Two considerations show that nothing in the moral and political spheres corresponds to the technological unification of the world; that, quite the contrary, the world is today further removed from moral and political unification than it was under much less favorable technological conditions.

First of all, modern technology, while enormously facilitating communications among different countries, has also given their governments and private agencies unprecedented power to make such communications impossible. Two hundred years ago it was easier for a literate Russian to learn about French political thought and action than it is today. An Englishman who wanted to spread his political ideas among the French had then a better chance than he has today. It was then simpler for a Spaniard to migrate or even to travel to the North American continent than it is today. For modern technology has not only made it technologically possible for the individual to communicate with other individuals regardless of geographical distances, it has also made it technologically possible for governments and private agencies of communication to cut off such communications altogether if they see fit to do so. And while the communications between individuals have remained largely in the realm of technical possibility, government and private controls have become a technical and political actuality.

Fifty years ago, the American citizen who wanted to visit a foreign country needed only to command the means of transportation in order to go there. Today the “One World” of technology will avail him nothing if he lacks one of those governmental papers without which no human being is able to cross a frontier. Yet, only in 1914, the stigma of backwardness and almost of barbarism attached to Russia and Turkey as the only two major countries which required a passport for leaving or entering the national territory. We ought

## World Public Opinion

not to forget that it is modern technology which has made totalitarian governments possible by enabling them to put their citizens on a moral and intellectual diet, feeding them certain ideas and information and cutting them off from others. It is also modern technology which has made the collection and dissemination of news and of ideas a big business requiring considerable accumulations of capital.

In the technologically primitive age, when printing was done by hand, any man of moderate means could reach the public ear by having a book, pamphlet, or newspaper printed and distributed at his own expense. Today the great mass of the people everywhere have no influence upon the mouthpieces of public opinion. With few exceptions, only men and organizations of considerable means and those who hold opinions approved by them can make themselves heard in the arena of public opinion. In virtually all countries the overwhelming weight of these opinions supports what the respective governments consider in their relations with foreign governments to be the national interest. Little information and few ideas unfavorable to the national point of view are allowed to reach the public. These assertions are too obvious to require elaboration. This is indeed "One World" technologically, but it is not for this reason that it is or will become "One World" morally and politically. The technological universe which is technically possible has no counterpart in the actual conditions under which information and ideas are exchanged among the members of different nations.

Yet, even if information and ideas were allowed to move freely over the globe, the existence of a world public opinion would by no means be assured. Those who believe that world public opinion is the direct result of the free flow of news and of ideas fail to distinguish between the technical process of transmission and the thing to be transmitted. They deal only with the former and completely disregard the latter. However, the information and ideas to be transmitted are the reflection of the experiences which have molded the philosophies, ethics, and political conceptions of different peoples. Were those experiences and their intellectual derivatives identical throughout humanity the free flow of information and of ideas would indeed create by itself a world public opinion. Actually, however, as we have seen, there is no identity of experience uniting mankind above the elemental aspirations which are common to all men. Since this is so, the American, Indian, and Russian — each will consider the same news item from his particular philosophic, moral, and political perspective, and the different perspectives will give the news a different color. The same report on the civil war in Greece or the Russo-Iranian Treaty concerning oil concessions will have a different weight as a newsworthy item, aside from any opinion to be formed about it, in the eyes of different observers.

Not only will the different perspective color the same piece of information, it will also affect the selection of what is newsworthy from among the infinite number of daily occurrences throughout the world. "All the News That's Fit to Print" means one thing for the *New York Times*, another thing for *Pravda*, and another thing for the *Hindustan Times*. A comparison of the actual content of those different newspapers on any particular day bears out that contention. When it comes to the interpretation of the news in the light

## *Politics among Nations*

of philosophy, morality, and politics, the cleavages which separate the members of different nations from each other become fully manifest. The same item of information and the same idea mean something different to an American, a Russian, and an Indian; for that item of information and that idea are perceived by, assimilated to, and filtered through minds which are conditioned by different experiences and molded by different conceptions of what is true, good, and politically desirable and expedient.

Thus, even if we lived in a world actually unified by modern technology with men, news, and ideas moving freely regardless of national boundaries, we would not have a world public opinion. For while the minds of men would be capable of communicating with each other without political impediments, they would not meet. Even if the American, Russian, and Indian could speak to each other, they would speak with different tongues, and if they uttered the same words, they would signify different objects, values, and aspirations to each of them. So it is with concepts, such as democracy, freedom, security. The disillusion of differently constituted minds communicating the same words, which embody their most firmly held convictions, deepest emotions, and most ardent aspirations, without finding the expected sympathetic response, has driven the members of different nations further apart rather than united them. It has tended to harden the core of the different national public opinions and to strengthen their claims for exclusiveness rather than to merge them into a world public opinion.

### 3. THE BARRIER OF NATIONALISM

In order to illustrate the importance of this last observation, let us consider Woodrow Wilson's Fourteen Points. During the last months of the First World War, the Fourteen Points were accepted by so substantial a portion of humanity, regardless of national boundaries and of allegiance to one or the other of the belligerent camps, as principles for a just and enduring peace settlement that there indeed seemed to exist a world public opinion in support of them. Yet, as Mr. Walter Lippmann's brilliant analysis of the public opinion supporting the Fourteen Points has made clear:

It would be a mistake to suppose that the apparently unanimous enthusiasm which greeted the Fourteen Points represented agreement on a program. Everyone seemed to find something that he liked and stressed this aspect and that detail. But no one risked a discussion. The phrases, so pregnant with the underlying conflicts of the civilized world, were accepted. They stood for opposing ideas, but they evoked a common emotion. And to that extent they played a part in rallying the western peoples for the desperate ten months of war which they had still to endure.

As long as the Fourteen Points dealt with that hazy and happy future when the agony was to be over, the real conflicts of interpretation were not made manifest. They were plans for the settlement of a wholly invisible environment, and because these plans inspired all groups each with its own private hope, all hopes ran together as a public hope. . . . As you ascend the hierarchy in order to include more and more factions you may for a time preserve the emotional connection though you lose the intellectual. But even the emotion becomes thinner.

As you go further away from experience, you go higher into generalization or subtlety. As you go up in the balloon you throw more and more concrete objects overboard, and when you have reached the top with some phrase like the Rights of Humanity or the World Made Safe for Democracy, you see far and wide, but you see very little. Yet the people whose emotions are entrained do not remain passive. As the public appeal becomes more and more all things to all men, as the emotion is stirred while the meaning is dispersed, their very private meanings are given a universal application. Whatever you want badly is the Rights of Humanity. For the phrase, ever more vacant, capable of meaning almost anything, soon comes to mean pretty nearly everything. Mr. Wilson's phrases were understood in endlessly different ways in every corner of the earth. . . . And so, when the day of settlement came, everybody expected everything. The European authors of the treaty had a large choice, and they chose to realize those expectations which were held by those of their countrymen who wielded the most power at home.

They came down the hierarchy from the Rights of Humanity to the Rights of France, Britain and Italy. They did not abandon the use of symbols. They abandoned only those which after the war had no permanent roots in the imagination of their constituents. They preserved the unity of France by the use of symbolism, but they would not risk anything for the unity of Europe. The symbol France was deeply attached, the symbol Europe had only a recent history. . . .<sup>7</sup>

Mr. Lippmann's analysis of the apparent world public opinion supporting Wilson's Fourteen Points lays bare the crux of the problem — the interposition of nationalism with all its intellectual, moral, and political concomitants between the convictions and aspirations of humanity and the world-wide issues which face men everywhere. While men everywhere subscribed to the words of the Fourteen Points, it was the particular nationalisms, molding and directing the minds of men, which infused their particular meanings into these words, painted them with their particular color, and made them symbols of their particular aspirations.

Yet nationalism has the same effect upon issues with regard to which humanity has developed not only common verbal expressions, such as the Fourteen Points, democracy, freedom, and security, but also an actual consensus bearing upon the substance of the case. In contemporary international politics there is no opinion more widely held anywhere in the world than the abhorrence of war, the opposition to it, and the desire to avoid it. When they think and speak of war in this context, the men in the streets in Washington, in Moscow, in Chungking, in New Delhi, in London, in Paris, and in Madrid have pretty much the same thing in mind, that is, war waged with the modern means of mass destruction. There appears to exist a genuine world public opinion with respect to war. But here again the appearances are deceptive. Humanity is united in its opposition to war in so far as that opposition manifests itself in philosophic terms, moral postulates, and abstract political aspirations, that is, with regard to war as such, with regard to war in the abstract. But humanity thus united reveals its impotence, and the apparent world public opinion splits into its national components, when the issue is no

<sup>7</sup> Walter Lippmann, *Public Opinion*, pp. 214 ff. Copyright 1922, by The Macmillan Company and used with their permission.

## *Politics among Nations*

longer war as such, in the abstract, but a particular war, this particular war; not any war, but war here and now.

When actual war threatens in our time, as it did in the recurring crises of 1938-39, humanity remains united in its horror of war as such and in opposition to it. But men are incapable of translating this abstract opposition to war as such into concrete action against this particular war. While most members of the human race, *qua* members of the human race, consider war under the conditions of the mid-twentieth century an evil which will make the winner only slightly less miserable than the loser, most members of the human race, *qua* Americans, Chinese, Englishmen, and Russians, look at a particular war, as they have always done, from the point of view of their particular nations. They oppose wars which do not affect what they regard as their national interest, such as Italy's war against Ethiopia, yet they are unwilling to take or to support any action which might be effective in preventing or putting an end to the war. For, if it is to be effective, such action must be drastic, involving certain disadvantages and risks for what is considered to be the national interest. Customers may be lost and friends estranged; even the risk of an armed conflagration for other than national objectives might have to be faced.

The sanctions against Italy, after it had attacked Ethiopia, are the classic example of this general condemnation of war by so-called world public opinion and of its unwillingness to take effective action seemingly not required by what is considered to be the national interest. Winston Churchill trenchantly formulated this dilemma between condemnation of war in the abstract and the unwillingness to act effectively in a concrete situation, when he said of the representatives of the British sector of that "world public opinion": "First the Prime Minister had declared that sanctions meant war; secondly, he was resolved that there must be no war; and thirdly, he decided upon sanctions. It was evidently impossible to comply with these three conditions."<sup>8</sup>

World public opinion, however, ceases to operate at all as one united force whenever a war threatens or breaks out which affects the interests of a number of nations. Under such circumstances, the universal condemnation of war undergoes a significant change in focus. The opposition to war as such is transformed into opposition to the nation which threatens to start, or actually has started, a particular war, and it so happens that this nation is always identical with the national enemy whose belligerent attitude threatens the national interest and, therefore, must be opposed as a war-monger. In other words, out of the common soil of the universal condemnation of war there arise specific acts of condemnation directed against whoever threatens through war the interests of particular nations. There will then be as many war-mongers condemned by national public opinions as there are nations threatening the interests of others through war.

The situation throughout the world from 1938 on is instructive in this respect. Throughout this last decade all nations have uniformly been opposed to war in general. Yet, when it came to the formation of an active public opinion which would take action in order to prevent or to oppose a particular

---

<sup>8</sup> *London Evening Standard*, June 26, 1936.



war, the lines were drawn according to the national interest involved in the particular situation. Thus the public opinion of Great Britain and France, throughout that period, condemned Germany as a potential or actual threat of war, yet it condemned the Soviet Union on that count only from August 1939 to June 1941, that is, during the operation of the Russo-German pact. Since the end of 1945, public opinion in these two countries has again become critical of the foreign policies of the Soviet Union as a threat to world peace.

Russian public opinion, on the other hand, opposed Germany as the main threat to peace until the signing of the pact with Germany in August 1939. From then until the German attack against the Soviet Union in June 1941, the Western democracies were regarded as war-mongers. Germany's attack swung Russian opinion against it and until about the end of 1945 Germany held its former place in the Russian public mind as a threat to peace. Since the end of 1945, with ever increasing emphasis, Russian public opinion has come to consider the United States as the main threat to peace. American public opinion coincided in different degrees of intensity with the British and French point of view up to the end of 1945. Then, returning the Russian compliment, it started to regard the Soviet Union as the main menace to peace. The intensity of this opinion in the United States has mounted at a rate paralleling the rising intensity of opinion in the Soviet Union.

Thus, whenever a concrete threat to peace develops, war is opposed not by a world public opinion, but by the public opinions of those nations whose interests are threatened by that war. It follows that it is obviously futile to base one's hopes for the preservation of peace in the world, as it is presently constituted, upon a world public opinion which exists only as a general sentiment, but not as a source of action capable of preventing a threatening war.

Wherever one probes beneath the surface of popular phraseology, one finds that a world public opinion restraining the international policies of national governments does not exist. A final general consideration of the nature of public opinion, as it becomes active in the mores of society, will show that under present world conditions this cannot be otherwise. While one can visualize a society without an active public opinion and while there have doubtless existed and still exist authoritarian societies whose public opinion does not operate as an active force in the sphere of international politics, obviously no public opinion can exist without a society. Society, however, means consensus concerning certain basic moral and social issues. This consensus is predominantly moral in character when the mores of society deal with political issues. In other words, when public opinion in the form of the mores becomes operative with regard to a political problem, the people generally try to bring their moral standards to bear upon that problem and to have it solved in accordance with those standards. A public opinion capable of exerting a restraining influence upon political action presupposes a society and a common morality from which it receives its standards of action, and a world public opinion of this kind requires a world society and a morality by which humanity as a whole judges political actions on the international scene.

As we have seen, such a world society and such a universal morality do not exist. Between the elemental aspirations for life, freedom, and power,

which unite mankind and which could provide the roots for a world society and universal morality, and the political philosophies, ethics, and objectives actually held by the members of the human race, there intervenes the nation. The nation fills the minds and hearts of men everywhere with particular experiences and, derived from them, with particular concepts of political philosophy, particular standards of political morality, and particular goals of political action. Inevitably, then, the members of the human race live and act politically not as members of one world society applying standards of universal ethics, but as members of their respective national societies guided by their national standards of morality. In politics the nation, and not humanity, is the ultimate fact. Inevitably, then, what is real are national public opinions fashioned in the image of the political philosophies, ethics, and aspirations of the respective nations. A world public opinion restraining the international policies of national governments is a mere postulate; the reality of international affairs shows as yet hardly a trace of it.

When a nation invokes "world public opinion" or "the conscience of mankind" in order to assure itself, as well as other nations, that its international policies meet the test of standards shared by men everywhere, it appeals to nothing real. It only yields to the general tendency, with which we have dealt before, to raise a particular national conception of morality to the dignity of universal laws binding upon all mankind. The confidence with which all the antagonists in the international arena believe themselves to be supported by world public opinion with respect to one and the same issue only serves to underline the irrationality of the appeal. In the twentieth century, as we have seen, people want to believe that they champion not only, and perhaps not even primarily, their own national interests, but the ideals of humanity as well. For a scientific civilization which receives most of its information about what other people think from public-opinion polls, world public opinion becomes the mythical arbiter who can be counted upon to support one's own, as well as everybody else's, aspirations and actions. For those more philosophically inclined, the "judgment of history" fulfills a similar function. For the religious, there is the "will of God" to support their cause, and believers witness the strange and singularly blasphemous spectacle of one and the same God blessing through his ministers the arms on either side of the battle line and leading both armies either to deserved victory or to undeserved defeat.

*PART SIX*

LIMITATIONS  
OF INTERNATIONAL POWER:  
INTERNATIONAL LAW



## CHAPTER XVI

# *The Main Problems of International Law*

### I. THE GENERAL NATURE OF INTERNATIONAL LAW

The same caution against extremes, with which we started the discussion of international morality and of world public opinion, must apply also to the discussion of international law. An increasing number of writers express the opinion that there is no such thing as international law. A diminishing number of observers hold that international law, if duly codified and extended to regulate the political relations of states, could become through its own inner force, if not a substitute for, at least a restraining influence upon, the struggle for power on the international scene. As Professor Brierly puts it:

Too many people assume, generally without having given any serious thought to its character or its history, that international law is and always has been a sham. Others seem to think that it is a force with inherent strength of its own, and that if only we had the sense to set the lawyers to work to draft a comprehensive code for the nations, we might live together in peace and all would be well with the world. Whether the cynic or the sciolist is the less helpful is hard to say, but both of them make the same mistake. They both assume that international law is a subject on which anyone can form his opinions intuitively, without taking the trouble, as one has to do with other subjects, to inquire into the relevant facts.<sup>1</sup>

The modern system of international law is the result of the great political transformation which marked the transition from the Middle Ages to the modern period of history. It can be summed up as the transformation of the feudal system into the territorial state. The main characteristic of the latter, distinguishing it from its predecessor, was the assumption by the government of the supreme authority within the territory of the state. The monarch no longer shared authority with the feudal lords within the state territory of which he was in large measure the nominal rather than the actual head.

---

<sup>1</sup> J. L. Brierly, *The Outlook for International Law* (Oxford: The Clarendon Press, 1944), pp. 1, 2. (Reprinted by permission of the publisher.)

## *Politics among Nations*

Nor did he share it with the Church which throughout the Middle Ages had claimed in certain respects supreme authority within Christendom. When this transformation had been consummated in the sixteenth century, the political world consisted of a number of states which within their respective territories were, legally speaking, completely independent of each other, recognizing no earthly authority above themselves. In one word, they were sovereign.

If there was to be at least a certain measure of peace and order in the relations among such entities endowed with supreme authority within their territories and having continuous contact with each other, it was inevitable that certain rules of law should govern these relations. That is to say, there must be certain rules of conduct defined beforehand, whose violation would normally call forth certain sanctions, also defined beforehand as to their nature and the conditions and mode of their application. States must, for instance, know where the frontiers of their territory are on land and on sea. They must know under what conditions they can acquire a valid title to territory either owned by no one at all as in the case of discovery, or by another state as in the case of cession or annexation. They must know what authority they have over citizens of other states living on their territory and over their citizens living abroad. When a merchant vessel flying the flag of State A enters a port of State B, what are the rights of State B with regard to that vessel? And what if the vessel is a warship? What are the rights of diplomatic representatives accredited to a foreign government and what are the rights of the head of the state on foreign soil? What is a state allowed and obligated to do in times of war with respect to combatants, civilians, prisoners, neutrals, on the sea and on land? Under what conditions is a treaty between two or more states binding, and under what conditions does it lose its binding force? And if a treaty or another rule of international law is claimed to have been violated, who has the right to ascertain the violation and who has the right to take what kind of enforcement measures and under what conditions? These and many other issues of a similar nature rise of necessity from the relations among sovereign states, and if anarchy and violence are not to be the order of the day, legal rules must determine the mutual rights and obligations in such situations.

A core of rules of international law laying down the rights and duties of states in relation to each other developed in the fifteenth and sixteenth centuries. These rules of international law were securely established in 1648, when the Treaty of Westphalia brought the religious wars to an end and made the territorial state the cornerstone of the modern state system. Hugo Grotius' *On the Law of War and Peace*, published in 1628, is the classic codification of that early system of international law. On its foundation, the eighteenth and, more particularly, the nineteenth and twentieth centuries built an imposing edifice, consisting of thousands of treaties, hundreds of decisions of international tribunals, and innumerable decisions of domestic courts. These treaties and decisions regulate, often in minute detail, the relations between nations arising from the multiplicity and variety of international contacts which are the result of modern communications, international exchange of goods and services, and the great number of international organizations, such as the In-

## *The Main Problems of International Law*

ternational Red Cross, the Permanent Court of International Justice and its successor, the International Court of Justice, the League of Nations, the United Nations, the United Nations Educational, Scientific and Cultural Organization (UNESCO), the Universal Postal Union, the International Institute of Agriculture, the International Monetary Fund, and many others, in which most nations have co-operated for the furtherance of their common interests.

It is also worth mentioning, in view of a widespread misconception in this respect, that during the four hundred years of its existence international law has in most instances been scrupulously observed. When one of its rules was violated, it was, however, not always enforced and, when law enforcement action was actually taken, it was not always effective. Yet to deny that international law exists at all as a system of binding legal rules flies in the face of all the evidence. This misconception as to the existence of international law is at least in part the result of the disproportionate attention which public opinion has paid in recent times to a small fraction of international law, while neglecting the main body of it. Public opinion has been concerned mainly with spectacular instruments of international law, such as the Briand-Kellogg Pact, the Covenant of the League of Nations, and the Charter of the United Nations. These instruments are indeed of doubtful efficacy and sometimes even of doubtful validity. They are, however, not typical of the traditional rules of international law concerning, for instance, the limits of territorial jurisdiction, the rights of vessels in foreign waters, and the status of diplomatic representatives.

To recognize that international law exists is, however, not tantamount to asserting that it is as effective a legal system as the national legal systems are and that, more particularly, it is effective in regulating and restraining the struggle for power on the international scene. International law is a primitive type of law resembling the kind of law which prevails in certain preliterate societies, such as the Australian aborigines and the Yurok of Northern California.<sup>2</sup> It is a primitive type of law primarily because it is almost completely decentralized law. It is decentralized with regard to the three basic functions which any legal system must fulfill: legislation, adjudication, and enforcement.

### 2. THE LEGISLATIVE FUNCTION IN INTERNATIONAL LAW

#### *a) Its Decentralized Character*

In our contemporary domestic societies, the most important rules of law are created by legislators and courts, that is to say, by centralized agencies which create law either for all members of the national community, as do Congress and the Supreme Court of the United States, or for certain regional groups, as do state legislatures, city councils, and regional and local courts.

---

<sup>2</sup> See A. R. Radcliffe-Brown, "Primitive Law," *Encyclopedia of the Social Sciences*, IX, 203-204; for literature, see p. 262.

## *Politics among Nations*

In the international sphere there are but two forces creating law: necessity and mutual consent. International law contains a small number of rules concerning, for instance, the limits of national sovereignty, the interpretation of its own rules, and the like. These rules are binding upon individual states regardless of their consent, for without these rules there could be no legal order at all or at least no legal order regulating a multiple state system. Aside from this small number of rules of what one might call common international law, the main bulk of rules of international law owe their existence to the mutual consent of the individual subjects of international law themselves — the individual nations. Each nation is bound only by those rules of international law to which it has consented either implicitly through customary enforcement or explicitly through treaty.

The main instrumentality by which international law is created is the international treaty. Custom as a source of international law has lost much of its importance in the last two centuries. An international treaty creates international law only for those nations which are a party to it. A treaty concluded among the American nations binds only them and no other nation. A treaty concluded between the Soviet Union and Iran has usually no legal effect for any third nation.<sup>3</sup> Hence, the conditions under which the legislative function operates in the field of international law is similar to what would exist on the domestic scene if the legislative function within the United States were to be performed by the individual citizens themselves in the form of private contracts, instead of by legislatures and courts operating under the rule of *stare decisis*, that is, bound by precedents. Instead of a municipal law regulating sewage disposal or zoning in a certain municipality, these issues would be taken care of by a number of private agreements concluded among the residents of the different streets. The municipality, then, would have as many regulations as there are streets. The inevitable result of such a system of legislation would be, on the one hand, lack of legal regulation altogether whenever the unanimous consent of all those concerned was not forthcoming. On the other hand, there would be uncertainty about what the law actually was in a particular case, and there would be contradictions among the different sets of rules regulating the same situations with regard to different individuals. That is the situation which exists in the field of international law, mitigated only by the relatively small number — approximately sixty — of subjects which might create international law by concluding treaties among themselves.

Many matters bearing upon international relations, such as immigration, and many aspects of economic policies, are not regulated by international law. The interests of the different nations in these matters are so divergent that they are unable to agree upon legal rules. In those matters with regard to which agreement was possible, insecurity and confusion frequently reign. If one wants to know which rules of international law the United States considers to be binding upon itself, one must consult all the treaties ever concluded by the United States, after determining which are still in force at the moment of investigation. Then one must examine the decisions of international tribu-

---

<sup>3</sup> As an exception, there are international treaties creating rights and obligations for states not parties to the treaty. For examples, see Hans Kelsen, *General Theory of Law and State* (Cambridge: Harvard University Press, 1945), pp. 352-353.



## *The Main Problems of International Law*

nals in cases to which the United States has been a party and the decisions of American courts applying rules of international law. Finally, one must study the diplomatic documents in which the representatives of the United States in international negotiations have acknowledged certain rules of international law as binding upon the conduct of the United States in international affairs. The sum total of all these rules is what Professor Charles C. Hyde has called *International Law Chiefly as Interpreted and Applied by the United States*.<sup>4</sup>

By a similarly tedious process, the rules of international law recognized by other nations have also been compiled. In order to know the sum total of the rules of international law binding in a particular period of history throughout the world, it would be theoretically necessary to make similar compilations with regard to all nations of the world. If such a task were actually undertaken, its results would undoubtedly show considerable divergencies with regard to general principles as well as particular rules. World-wide compilations in limited fields of international law illustrate this lack of agreement. Many writers refer to continental law in contrast to Anglo-American international law, to the international law of the Americas, and to the Russian conception of international law.<sup>5</sup>

To take as a specific example the breadth of the maritime belt, that is, the question as to how far into the sea the territorial jurisdiction of the adjacent state extends, the rules of international law recognized by different states in this field differ sharply. While a number of states adhere to the principle of the three-mile limit, Norway and Sweden, over the objections of other states, claim a breadth of four miles for the maritime belt. Italy, Brazil, Spain, Iran, Rumania, Turkey, and Yugoslavia claim one of six miles. Other nations, such as Germany, Belgium, France, and Poland, claim for protective purposes a so-called contiguous zone beyond the territorial waters proper. Other states, such as Great Britain, while rejecting the claim of these states to a contiguous zone, recognize that under certain circumstances a state has the right to extend its jurisdiction beyond the three-mile limit and to submit the merchant vessels of foreign states to some measure of control.

After the outbreak of the Second World War, in October 1939, the twenty-one American republics declared that they "as a measure of self-protection. . . so long as they maintain their neutrality, are as of inherent right entitled to have those waters adjacent to the American continent, which they regard as of primary and direct utility in their relations, free from the commission of any hostile act by any non-American belligerent nation."<sup>6</sup> This claim for a wide and undefined extension of the territorial waters of the American republics for the purpose of protecting their neutral rights was not recognized by the belligerents and was expressly rejected by Great Britain. Similar claims for the extension of territorial waters have been advanced for purposes of fisheries, sanitation, prevention of illegal acts, such as smuggling and the like. They have been recognized by some states and rejected by others. Claim thus

<sup>4</sup> 2 vols. (Boston: Little, Brown, and Company, 1946).

<sup>5</sup> On these different conceptions of international law and the literature concerning them, cf. Oppenheim-Lauterpacht, *International Law* (6th ed.; London, New York, Toronto: Longmans, Green and Company, 1947), I, 50 ff.

<sup>6</sup> *International Conciliation* (January, 1940), No. 356, p. 27; *American Journal of International Law*, Vol. 34 (1940), Supplement, p. 17.

## *Politics among Nations*

stands against claim, and while most writers support the majority view of the three-mile limit, one of the greatest international lawyers of our time, Judge Anzilotti, is of the opinion that there exists at the present time no general rule of international law regulating the matter.<sup>7</sup>

This lack of precision, resulting from the confusing multitude of unilateral claims, which we found to prevail in the rules of international law concerning the breadth of the maritime belt, is not peculiar to this particular branch of international law. It permeates to a greater or lesser degree most branches of the law of nations by virtue of the decentralized character of the legislative function. Governments, however, are always anxious to shake off the restraining influence which international law might have upon their international policies, to use international law instead for the promotion of their national interests, and to evade legal obligations which might be harmful to them. They have used the imprecision of international law as a ready-made tool for furthering their ends. They have done so by advancing unsupported claims to legal rights and by distorting the meaning of generally recognized rules of international law. Thus the lack of precision, inherent in the decentralized nature of international law, is breeding ever more lack of precision, and the debilitating vice, which was present at its birth, continues to sap its strength.

### *b) The Problem of Codification*

In order to remedy this situation and to strengthen international law as a system of rules capable of regulating and restraining the international conduct of states, numerous attempts have been made since the end of the nineteenth century to codify those branches of international law which either are rent least apart by contradictory interpretations and claims or else are most in need of unification. Codification is as close as a decentralized system of law can come to true legislation.<sup>8</sup> For an instrument of international law, such as the Final Act of the Congress of Vienna of 1815 which codified international law with regard to free navigation on so-called international rivers (Articles 108 and 117) and with regard to the classification of diplomatic representatives (Article 118), is in its legal effects the equivalent of a genuine piece of international legislation in that it binds all or virtually all subjects of international law. It is only the requirement of the consent of all those who are to be bound by it — in contrast to the majority rule required by the democratic process of legislation — which sets codification of international law apart from genuine legislation.

Codifications of international law have been enacted in considerable number primarily in the field of communications and for humanitarian purposes. We mention as examples of the former type the General Telegraphic Convention of 1865, the International Radiotelegraphic Convention of 1912 and 1927, the International Telecommunication Convention of 1932, the General

<sup>7</sup> Quoted in Oppenheim-Lauterpacht, *International Law*, I, 444, note 4.

<sup>8</sup> The term "codification" is used in the text in the meaning of the creation of new law through general international agreements. We are not using the term here in the sense which is common in Anglo-American jurisprudence, that is, the transformation of customary law or legal rules established by judicial bodies into statutory law without changes in the law itself.

## *The Main Problems of International Law*

Postal Convention of 1874 with revisions, the Convention concerning the International Circulation of Motor Vehicles of 1909, the Convention and Statute of the Regime of Navigable Waterways of International Concern of 1921, the Air Navigation Convention of 1919, the Convention on International Civil Aviation of 1944, the Convention for the Protection of Works of Art and Literature of 1886 and 1928, the International Union for Protection of Industrial Property of 1883 with revisions, the Convention for the Unification and Improvement of the Metric System of 1875 and 1921. There are in force Conventions on the Unification of Rules with Respect to (A) Collisions at Sea; (B) Assistance and Salvage at Sea; (C) Safety of Life at Sea, etc.

There have been numerous codifications in the field of what is called private international law, that is, concerning matters of private law for whose settlement more than one state may claim jurisdiction. For the purpose of avoiding or solving conflicts among the different jurisdictions, international conventions, embracing most nations, have been concluded dealing with such matters as civil procedure, marriage, divorce, guardianship, foreign judgments, nationality.

In the humanitarian field one might mention the Geneva Conventions of 1864, 1906, and 1929 concerning the treatment of the wounded in armies in the field, and all the other conventions already referred to<sup>8</sup> which aim at the humanization of warfare in general, such as the Convention with Respect to the Laws and Customs of War on Land of 1864 and 1907 and the other conventions in this field adopted by The Hague Peace Conferences of 1864 and 1907; the International Opium Convention of 1912, 1925, and 1931, and the Slavery Convention of 1926 are other examples. Finally, numerous labor conventions concerning hours and conditions of work, wages, insurance, and the like, have been adopted by the International Labor Organization; many of them have been ratified and thus made binding by most industrial nations.

It will be noticed that in most of the matters dealt with in these general or near-general international treaties the interests of the individual nations can hardly clash, but will generally coincide; for virtually all nations have an identical or at least complementary interest in the uniform regulation of these technical or humanitarian matters. It is, however, significant that wherever a divergence of national interests was possible or actually occurred with regard to them, the subject matter was to that extent not settled by general treaties, or adherence to the treaty was far from general. Thus the conventions establishing uniform rules with regard to conflicting marriage and divorce laws have not been put into force by the nations requiring religious marriage, and the Soviet Union has not signed any of the labor conventions.

It was the Conference on the Progressive Codification of International Law, held under the auspices of the League of Nations at The Hague in 1930, which removed all doubts as to the great difficulties in codifying any branch of international law, however technical, once the nations concerned have identified themselves with a particular point of view. It revealed also outright impossibility of codification when the national interests of the nations, however insignificant in themselves, are involved. The League of Nations

---

<sup>8</sup> See above, pp. 178 ff.

## *Politics among Nations*

requested the conference to codify three branches of international law considered to be ripe for codification: the international law of nationality, of territorial waters, and of state responsibility. The conference was unable to reach any agreement with respect to territorial waters and state responsibility, and it could do no more than draft four conventions dealing with certain limited aspects of the international law of nationality. Even these conventions, which far from codify the whole international law of nationality, have been ratified by only ten states and hardly deserve to be called codifications in the sense in which the term is generally used. This spectacular failure not only demonstrated the inherent weakness of international law from the legislative point of view, but the fear of governments to compromise their national interests in some unforeseen way by agreeing to a certain rule of international law or a certain interpretation of an already recognized rule also raised doubts and created insecurity where there had been none before. As Professors Keeton and Schwarzenberger put it: "Foreign Offices added so many qualifications to what had been considered perfectly straightforward rules of international customary law that the attempt at codification merely compromised formerly unchallenged principles of international customary law."<sup>10</sup>

### *c) Interpretation and Binding Force*

The difficulty of substituting the unanimous consent of all subjects of international law for genuine international legislation becomes still more acute when states try to conclude general treaties dealing with political matters with binding effect for all or virtually all subjects of international law. This difficulty is illustrated by the Convention for the Pacific Settlement of International Disputes of 1899 and 1907, the Statute of the Permanent Court of International Justice and of the International Court of Justice, the General Act for the Pacific Settlement of International Disputes of 1928, the General Treaty for the Renunciation of War (Briand-Kellogg Pact), the Minorities Treaties, the Covenant of the League of Nations, and the Charter of the United Nations.

Leaving aside for the moment the treaties dealing with judicial organizations which pose particular problems to be discussed later,<sup>11</sup> we find that documents, such as the Covenant of the League of Nations and the Charter of the United Nations, present, from the point of view of legislation, a problem which in this form is alien to domestic law. We are referring to the problem of ascertaining the meaning of the particular provisions of these documents, of the rights they confer, of the obligations they impose. In the domestic sphere, this problem is solved by the legislative bodies themselves which generally try to make the legal rules they enact as precise as possible; by the courts which are continually engaged in the task of interpreting the laws by applying them to concrete cases; and by the executive and administrative agencies which issue orders performing the same function. International legal documents, such as the Covenant of the League of Nations and the

<sup>10</sup> George W. Keeton and Georg Schwarzenberger, *Making International Law Work* (London: Stevens and Sons, Ltd., 1946), p. 122.

<sup>11</sup> See below, pp. 220 ff., 346 ff.

## *The Main Problems of International Law*

Charter of the United Nations, as well as many others of a purely technical character, are vague and ambiguous not by accident or, like the American Constitution, for particular and exceptional reasons, but regularly and of necessity. For such documents, in order to obtain the approval of all subjects of the law, necessary for their acquiring legal force, must take cognizance of all the divergent national interests which will or might be affected by the rules to be enacted. In order to find a common basis on which all those different national interests can meet in harmony, rules of international law embodied in general treaties must often be vague and ambiguous, allowing all the signatories to read the recognition of their own national interests into the legal text agreed upon. If this should happen in the domestic sphere, as it has actually happened to a considerable extent with regard to the Constitution of the United States, some authoritative decision, whether of the Supreme Court as in the United States, or of Parliament as in Great Britain, would give concrete meaning to the vague and ambiguous provisions of the law.

In the international field, it is the subjects of the law themselves which not only legislate for themselves, but are also the supreme authority for interpreting and giving concrete meaning to their own legislative enactments. They will naturally interpret and apply the provisions of international law in the light of their particular and divergent conceptions of the national interest. They will naturally marshal them to the support of their particular international policies and will thus destroy whatever restraining power, applicable to all, these rules of international law, despite their vagueness and ambiguity, might have possessed. Mr. Jean Ray has well analyzed this situation when he said with regard to the Covenant of the League of Nations: "But the danger is obvious. If the members of the League as individuals have ultimate authority in matters of interpretation, divergent interpretations, all equally authoritative, are going to perpetuate themselves; and when an ambiguous text is being invoked in a conflict between two nations, there will be an impasse."<sup>12</sup> This has happened time and again in the history of the League of Nations, and the brief history of the United Nations has given us a number of instances of a similar nature.<sup>13</sup>

There is, finally, another difficulty which contributes to the weakness of international law from the legislative point of view, and that is the insecurity as to whether a certain international treaty, duly signed and ratified, contains actually, in whole or in part, valid rules of international law binding upon the signatories. Such a question could hardly arise with regard to a piece of domestic legislation in the United States. For a federal law has either been passed by Congress and signed by the President in conformity with the con-

---

<sup>12</sup> *Commentaire du Pacte de la Société des Nations* (Paris: Sirey, 1930), p. 44.

<sup>13</sup> In order to remedy this situation, the General Assembly of the United Nations passed in its Second Session, on November 14, 1947, a resolution declaring it to be of paramount importance that the interpretation of the Charter and of the constitutions of the specialized agencies be based on recognized principles of international law. The resolution called specifically upon the agencies of the United Nations to seek advisory opinions from the International Court of Justice on points of law which have arisen in the course of their activities (*United Nations Documents*, A/459). It remains to be seen, however, to what extent the representatives of the member states, speaking for these agencies, will make use collectively of the opportunity of which the member states have thus far made no use individually.

## *Politics among Nations*

stitutional requirements or it has not, and it has either been invalidated by the Supreme Court or it has not. There may be insecurity as to its constitutionality or interpretation until the Supreme Court has spoken with final authority, but not as to its very existence as a valid rule of law. It is this insecurity as to the existence of certain fundamental rules of international law, duly signed and ratified by virtually all members of the international community, which shakes the very foundation of international law.

Let us consider what is probably the most spectacular example of this type of international law, the Briand-Kellogg Pact, in which virtually all nations agreed "to renounce war as an instrument of national policy in their relations with one another." Has this agreement been from the beginning a rule of international law binding upon all signatories, or is it merely a statement of moral principle without legal effect? Has the international law of the Nuremberg trials, according to which the preparation for, and the waging of, aggressive war is an international crime, applied the already existing law of the Briand-Kellogg Pact, or has it created international law which did not exist before? <sup>14</sup> And has it done the one or the other only for the specific cases decided in Nuremberg or for any similar cases which might occur in the future? Different schools of thought have answered these questions in different ways, and this is not the place to settle the controversy. What is important to note in the context of this discussion is the weakness of a legal system which is incapable of giving a precise answer to so fundamental a question as to whether it forbids collective acts of violence for certain purposes. Thus there is today no way of stating with any degree of authority whether any country which went to war after 1929 in pursuance of its national policies has violated a rule of international law and is liable before international law for its violation; or whether only those individuals responsible for preparing and declaring the Second World War are liable in this way; or whether all countries and individuals which will prepare for, and wage, aggressive war in the future will thus be liable.

What about the legal validity of the Convention with Respect to the Laws and Customs of War on Land of 1899 and 1907 and its binding force upon its signatories in the Second World War and in a future war? This convention, which was fairly well observed during the First World War and whose violations were then pointed out regularly, was, as we have seen, <sup>15</sup> violated regularly and on a mass scale by all belligerents during the Second World War. Have these violations, unprotested and unpunished, brought the legal validity and the binding force of this convention to an end, or has the convention survived the Second World War as a legal instrument which can be invoked and made the standard of action in a future war? And what about similar questions with respect to the rules of maritime warfare which were also generally violated in the Second World War with hardly an attempt at enforcement being made? The Axis sank enemy ships indiscriminately and without warning and so did the United Nations, and both sides bombed civilians, justifying these violations of the rules of war with military necessity. If rules of

<sup>14</sup> Cf. Hans J. Morgenthau, Eric Hula, Moorhouse F. X. Millar, in *America*, Vol. 76, No. 10 (December 7, 1946), pp. 266-268.

<sup>15</sup> See above, pp. 181 ff.

## *The Main Problems of International Law*

international law are consistently violated and the violations are accepted as a matter of course by all subjects of the law, if, therefore, the legal rules are treated by those who ought to enforce them as though they did not exist, the question arises: Do they still exist as binding legal rules? No precise answer can be given to these questions at the moment. But, in view of the probable development of the technology of war and of international morality, the odds are against survival of these rules.

In 1936 the League of Nations' sanctions against Italy failed, and in the following years the wholesale violations of the most important provisions of the Covenant were treated with indifference by all governments concerned. Then similar questions were raised with respect to the Covenant of the League of Nations as a whole and to certain of its provisions. Governments acted as though those provisions had lost their binding force, but did they actually lose it or did their legal validity survive the crisis of the late thirties and of the Second World War to expire only with the formal dissolution of the League in 1946? No unequivocal and precise answer to these questions was forthcoming when they were first raised, nor is there an answer now. There can be little doubt that the transformation of the United Nations from what the Charter intended it to be into something quite different with the concomitant disregard of legal rules will confront the observer with similar questions and that his answers can only be uncertain, ambiguous, and tentative. The tentative, ambiguous, and uncertain character of the answers to so important and fundamental questions is again the measure of the deficiency of international law from the legislative point of view.

### 3. THE JUDICIAL FUNCTION IN INTERNATIONAL LAW

Despite these deficiencies resulting from the decentralized character of the legislative function, a legal system might still be capable of holding the aspirations for power of its subjects in check if there existed judicial agencies which could speak with authority whenever a dissension occurred with regard to the existence or the import of a legal rule. Thus the ambiguities and generalities of the American Constitution have been made largely innocuous through the compulsory jurisdiction of the Supreme Court in matters of constitutional interpretation. More particularly, the English common law has been given certainty and precision primarily by the decisions of courts and only to a small extent by formal legislative enactments. A hierarchy of judicial agencies performs in all developed legal systems the task of determining authoritatively and with finality the rights and duties of the subjects of the law.

If an individual citizen of the United States maintains against another American citizen that a federal statute does not apply to him either because of constitutional defects or in view of the meaning of the statute itself, either citizen can under certain procedural conditions submit his claim for an authoritative decision of the issue to a federal court. The jurisdiction of the court is established when the claim is made by either party; it is not dependent

## *Politics among Nations*

upon the consent of the other party. In other words, an American citizen can summon another citizen before a court of law to have their legal relations authoritatively determined, and is thus able to establish the jurisdiction of the court by his own unilateral action. The party which is dissatisfied with the decision can appeal to a higher court, until as the court of last resort the Supreme Court will say with finality what the law is in the case. That decision has, by virtue of the rule of *stare decisis*, the quality of a legislative action in that it creates law not only between the parties and with respect to the particular case, but with regard to all persons and situations to which the rationale of the decision applies.

International law is deficient in all three fundamentals of an efficient judicial system: compulsory jurisdiction, hierarchy of judicial decisions, and the application of the rule of *stare decisis* at least to the decisions of the highest court.

### *a) Compulsory Jurisdiction*

The sole source for the jurisdiction of international courts is the will of the states submitting disputes for adjudication. It is axiomatic in international law that no state can be compelled against its will to submit a dispute with another state to an international tribunal. In other words, no international court can take jurisdiction over international disputes without the consent of the states concerned. "It is well established in international law," the Permanent Court of International Justice said in the *Eastern Carelia Case*, "that no state can, without its consent, be compelled to submit its disputes with other states either to mediation or to arbitration, or to any other kind of pacific settlement. Such consent can be given once and for all in the form of an obligation freely undertaken, but it can, on the contrary, also be given in a special case apart from any existing obligation."<sup>16</sup>

In the case of so-called isolated arbitration,<sup>17</sup> that is, when the parties agree to submit one individual dispute, after it has occurred, to the jurisdiction of an international tribunal, this principle manifests itself simply in the requirement of a contractual obligation between the parties establishing the jurisdiction of the court. Thus, when the United States and Great Britain were unable to settle the Alabama claims by diplomatic negotiations, they agreed in a treaty to submit the dispute to an international tribunal. After the tribunal had rendered its judgment in this particular case, it disbanded; for its jurisdiction, derived from the treaty between the United States and Great Britain, was exhausted with the decision of this single case. If another dispute arose between the United States and Great Britain to be settled by international adjudication, another treaty would have to be concluded and a similar procedure followed. If no agreement could be reached between the parties as to

<sup>16</sup> P. C. I. J. Series B, No. 5, p. 27.

<sup>17</sup> We are using the terms "arbitration" and "adjudication" indiscriminately. While the former term is being used primarily for the judicial agencies which, prior to the establishment of the Permanent Court of International Justice, were created by bilateral agreements, the term "adjudication" is now generally used for all judicial agencies of an international character, regardless of the mode of their establishment.



## *The Main Problems of International Law*

the definition of the dispute, the composition and the procedure of the tribunal, and the legal rules to be applied, no judicial settlement would be possible.

In the case of so-called institutional arbitration, that is, when a whole class of disputes — for example, those of a legal character or those arising from a peace or commercial treaty — are submitted in advance of their occurrence to international adjudication by a general agreement, the consent of the parties is generally required for two different stages in the proceedings. It is required for the general agreement to submit certain classes of disputes to the jurisdiction of an international court. It is required for the particular agreement, also called *compromis*, that this particular dispute belongs to the class for which the general agreement provides international adjudication. When, for instance, an arbitration treaty between two nations provides that all legal disputes arising between them in the future shall be submitted to an international tribunal, neither state has as a rule the right to establish the jurisdiction of the court unilaterally, by simply submitting a particular legal dispute for adjudication. A special agreement relative to this particular dispute is necessary to establish the jurisdiction of the court.

The care with which states generally guard the contractual character of the jurisdiction of international courts is illustrated by Professor Lauterpacht: ". . . the majority of the judgements given by the Permanent Court of International Justice has been concerned with so-called 'pleas to the jurisdiction,' i.e., with the refusal of one party, supported by a rigid and ingenious interpretation of relevant arbitration agreements, to accord to the other party the right, which Hobbes regarded as elementary even in a state of nature, of impartial adjudication. This has been done, as a rule, not for the reason that another international agency was competent to decide the issue, but on the ground that the state in question was not bound by any commitment to have recourse to judicial settlement." Professor Lauterpacht adds that "even when the elementary duty of submission to adjudication is accepted [that is, in a general agreement], it is in practice often attended by elaborate reservations which reduce it to a mere formula devoid of any legal obligation."<sup>18</sup>

**THE OPTIONAL CLAUSE.** It is obvious that under such circumstances it is hardly possible to speak of a general obligation on the part of states to submit disputes to judicial settlement in advance of their occurrence. The requirement of a special agreement concerning the particular dispute to be adjudicated and the qualification of the general agreement by reservations virtually preclude compulsory litigation. They allow a state to preserve its freedom of action in all stages of the preliminary proceedings if it so wishes. It was for the purpose of assimilating the international judicial function, at least with regard to certain classes of disputes, to the strict compulsion of domestic litigation that Article 36 of the Statute of the Permanent Court of International Justice has created the so-called "optional clause." This ingenious device is incorporated without change in Article 36 of the Statute of the new Inter-

---

<sup>18</sup> H. Lauterpacht, *The Function of Law in the International Community* (Oxford: The Clarendon Press, 1933), p. 427. (Reprinted by permission of the publisher.)

## *Politics among Nations*

national Court of Justice. The provision gives the signatories of the Statute the opportunity to "recognize as compulsory *ipso facto* and without special agreement, in relation to any other state accepting the same obligation, the jurisdiction of the Court in all legal disputes."

Under the regime of the old Court the clause was binding, at one time or another, for close to fifty states. Under the new Statute the number of signatories by the end of 1947 fell short of thirty. Very few states, however, have signed without reservations. It must be emphasized that Article 36 itself contains two reservations, one implicit, the other explicit, which qualify for all signatories the compulsory character of the jurisdiction of the court under the optional clause. By limiting compulsory jurisdiction to legal disputes, the statute excludes all disputes of a nonlegal character. Since this limitation is, as we shall see,<sup>19</sup> very difficult to define, it opens avenues of evasion for states intent on preserving their freedom of action. The other reservation is explicitly one of reciprocity; compulsory jurisdiction is operative only if both parties to the dispute have accepted it.

To these reservations which limit the jurisdiction of the Court for all signatories, the signatories have added numerous others, some of limited importance, others virtually nullifying the compulsory character of the jurisdiction. Thus certain states have exempted territorial questions from the operation of the optional clause. A great number of others have exempted questions which fall under the domestic jurisdiction of the state concerned. Others have made an exception of disputes for which the parties have agreed, or shall agree, upon another kind of settlement. A further exception has been made of disputes of which the underlying facts and situations arose before the compulsory jurisdiction of the court became binding upon the states concerned.

Referring to the use of this last reservation by Great Britain, Professor Brierly has said: "It would be difficult to devise a more indefinite formula; but one thing at least is clear about it, that it most seriously limits the scope of our undertaking."<sup>20</sup> International disputes are often protracted and the factual situations underlying many of them have a long history. This reservation is, therefore, particularly liable to remove great numbers of disputes from the operation of the optional clause. The considerable number of states which have made use of several reservations cumulatively have reduced to a minimum the compulsory character of the Court's jurisdiction under the optional clause. The corroding influence of such reservations may completely eat away the compulsory jurisdiction of the Court. The acceptance of such jurisdiction may become again, as it was so often in arbitration treaties concluded before the First World War, in the words of Professor Lauterpacht, "a mere formula devoid of any legal obligation."

The declaration of the United States of August 14, 1946, accepting the compulsory jurisdiction of the International Court of Justice is the prototype of an acceptance so weakened by far-reaching reservations as to reduce the strict legal obligation to the vanishing point. According to its terms:

---

<sup>19</sup> See below, pp. 341 ff.

<sup>20</sup> *The Law of Nations* (Oxford: Oxford University Press, 1942), p. 216.

## *The Main Problems of International Law*

- . . . this declaration shall not apply to
- a.* disputes the solution of which the parties shall entrust to other tribunals by virtue of agreements already in existence or which may be concluded in the future; or
  - b.* disputes with regard to matters which are essentially within the domestic jurisdiction of the United States of America as determined by the United States of America; or
  - c.* disputes arising under a multilateral treaty, unless (1) all parties to the treaty affected by the decision are also parties to the case before the Court, or (2) the United States of America specially agrees to jurisdiction . . .<sup>21</sup>

While the reservation under *a.* is of minor importance, it is hard to visualize an international dispute which might not be interpreted so as to be covered by either reservation *b.* or *c.* There are few matters liable to become the object of an international dispute on which the domestic jurisdiction of the countries concerned would not have some bearing. Does a trade agreement concluded between the United States and a foreign country remove the subjects which it regulates from the category of matters which are "essentially within the domestic jurisdiction of the United States"? What about international treaties concerning immigration, foreign loans, limitation of armaments? Matters thus dealt with by international law are surely no longer "exclusively" within the domestic jurisdiction of the United States. But when do they cease to be "essentially" within that jurisdiction? Obviously, when the United States is no longer interested in preserving its freedom from judicial control with regard to such matters. Since what is and what is not "essentially" within the domestic jurisdiction of the United States is thus a matter of political opinion and since according to reservation *b.* the opinion of the United States will decide this issue without appeal, the United States will be able, if it so wishes, by virtue of reservation *b.* alone to exclude from the jurisdiction of the Court most disputes to which it might be a party. Even if the opinion of the United States in this respect were clearly arbitrary and without factual foundation, the terms of the declaration make the United States the final judge in the matter.

Reservation *c.* takes care of whatever reservation *b.* might have left to the compulsory jurisdiction of the Court. In modern times many of the more important international treaties, especially in view of their bearing on international politics, are multilateral, such as the Pan-American Treaties, the Charter of the United Nations, and the peace treaties terminating the Second World War. Considering the limited number of adherences to the optional clause and considering the possibilities of evasion with the aid of reservations, it is not likely that in the case of a dispute arising under such a treaty all the signatories of the treaty, numbering often more than a score or two of states, can simultaneously be made parties before the Court. The United States, then, is likely to retain its freedom of action in most cases where its acceptance of the compulsory jurisdiction of the Court with regard to multilateral treaties is involved.

Thus, in the end, the development of compulsory jurisdiction under the

---

<sup>21</sup> Document United States/International Court of Justice/5, *Department of State Bulletin*, Vol. 15, No. 375 (September 8, 1946), p. 452.

## *Politics among Nations*

optional clause reverts to where it started from: the preservation, in a large measure and for the most important disputes, of the freedom of action of states with regard to the jurisdiction of international courts. The legal instrumentalities designed to preserve that freedom have become more refined under the regime of the optional clause. Instead of frankly exempting from adjudication the most important classes of disputes, they now serve primarily the purpose of smoothing over and concealing the contrast between verbal adherence to compulsory jurisdiction and actual unwillingness to accept it. It is, therefore, not surprising that the Permanent Court of International Justice has been in the main concerned, not with the limitation of the struggle for power on the international scene, but with the preliminary question whether the parties were at all under obligation to submit the case to the jurisdiction of the Court. Only once did the Permanent Court of International Justice have to face squarely the problem of limiting a state's aspirations for power. That was in the case of the German-Austrian Customs Union,<sup>23</sup> and there the jurisdiction of the Court was founded, not upon an agreement freely entered into by the parties, but upon Article 14 of the Covenant of the League of Nations authorizing the Council of the League to request advisory opinions from the Court. It is also worthy of note that, although the community of nations has been rent apart by many disputes of different kinds, the International Court of Justice, organized in the spring of 1946, had still to hear and decide its first case two years later.

All theoretical and practical considerations point to the conclusion that the optional clause has left the substance of the problem of compulsory jurisdiction where it found it. In the field of adjudication only slightly less than in the field of legislation, it is still the will of the states which is decisive in all stages of the proceedings. Hence, international adjudication is unable to impose effective restraints upon the struggle for power on the international scene. Loose and ambiguous formulations of the general duty to submit to litigation and, in particular, a great variety of indefinite and sweeping reservations protect all states against the risk to have to submit any specific dispute to international litigation against their will. Hence, with regard at least to compulsory jurisdiction over important disputes, the decentralization of the judicial function in the international sphere is complete, barely disguised by formulae of legal obligation which, in turn, are rendered meaningless by reservations.

### *b) International Courts*

Since no legal system can be effective in limiting the activities of its subjects without compulsory jurisdiction over their disputes, the two other fundamental problems of adjudication—the organization of the judicial agencies and the effects of their decisions—are of subordinate importance. The establishment of the Permanent Court of International Justice and of its successor, the International Court of Justice, marks an important step, perhaps the most important of all, toward the centralization of functions in the

---

<sup>23</sup> P. C. I. J. Series A/B, No. 41.

## *The Main Problems of International Law*

field of international law. Up to the establishment of the Permanent Court in 1920 judicial organization in the international sphere was completely decentralized. That is to say, whenever two states agreed upon the judicial settlement of a specific dispute, they also agreed upon a particular person, such as the Pope, a prince, a famous international lawyer, or a group of persons to function as a tribunal for the decision of this particular case. With the settlement of this dispute, the judicial function of this tribunal was automatically at an end. The judicial settlement of another dispute required the establishment of another tribunal. The Tribunal of Geneva which decided the Alabama case referred to above<sup>23</sup> well illustrates this situation.

The Hague Convention for the Pacific Settlement of International Disputes of 1899 and 1907 tried to overcome this decentralization of the judicial organization by creating the so-called Permanent Court of Arbitration. The latter consists only of a panel of some 120 judges appointed by the different signatories to the convention. From this panel the parties to a specific dispute can select the members of a tribunal to be constituted for the adjudication of this specific dispute. It might, therefore, well be said that this institution is neither permanent nor a court. The so-called Court does not exist as a body; as such it does not fulfill judicial or any other functions. It is actually nothing more than a list of individuals "of recognized competence in questions of International Law, enjoying the highest moral reputation."<sup>24</sup> It facilitates the selection of judges for one of the special tribunals to be organized for the adjudication of a specific dispute. The so-called Permanent Court of Arbitration has never decided a case; only individual members of the panel have. It perpetuates the decentralization of judicial organization in the international field, while at the same time recognizing in the pretense of its name the need for a centralized judicial authority.

The main stumbling block for the establishment of a really permanent international court was the composition of the court. Nations were as anxious to preserve their freedom of action with respect to the selection of judges for each specific case, as they have been anxious to preserve their freedom of action with regard to the submission of each specific dispute to adjudication. More particularly, nations were reluctant to allow a dispute to be decided by an international tribunal of which neither one of their nationals nor a representative of their point of view was a member. No permanent international court with jurisdiction over more than a limited number of nations could meet the letter of such a requirement; for the number of nations subject to the jurisdiction of a world court would of necessity exceed the number of judges. The small nations, especially, feared that under these conditions most of them would be permanently deprived of representation in such a court, which might thus easily become an instrument of the great powers.

The Statute of the Permanent Court of International Justice and of its successor has solved this problem. The Court is composed of fifteen members, no two of whom may be nationals of the same state (Article 3). On the other hand, "The electors shall bear in mind . . . that in the body as a whole the

---

<sup>23</sup> See above, p. 220.

<sup>24</sup> Article 44 of the Convention.

## *Politics among Nations*

representation of the main forms of civilization and of the principal legal systems of the world should be assured" (Article 19). The members of the Court are nominated and elected through a number of ingenious devices designed to insure high professional standards as well as compliance with the requirement of Article 19 of the Statute. The nominations are made by the members of the Permanent Court of Arbitration, organized into national groups, or by national groups appointed by their respective governments (Articles 4, 5, 6). The election is by absolute majority of the votes of the General Assembly and the Security Council of the United Nations, each body voting independently of the other (Articles 8-12). Article 31 of the Statute makes the additional concession of providing for special national judges who may be chosen by parties whose nationality is not represented among the members of the Court.

This Court, a truly centralized judicial agency, fulfills through its very existence two important functions for the international community. On the one hand, the Court, through being established in permanence and independently of any occurring disputes, is always available to states which want to settle their differences by means of adjudication. Whatever else may stand in the way of a judicial settlement of their disputes, the problems of establishing a tribunal, selecting its members, providing for its procedure and substantive law have been solved for them once and for all by the Statute of the Court. The difficulties to which these problems, to be solved anew for each individual case of adjudication, may have given rise before 1920 no longer stand in the way of effective administration of international justice.

The International Court of Justice, whose members are elected for a period of nine years and may be re-elected, provides for continuity in the performance of its judicial task. This quality is necessarily absent in a tribunal convened for the settlement of a specific dispute and terminating its existence with the rendering of the judgment. A court whose membership is bound to remain approximately identical for almost a decade and may easily remain identical much longer cannot fail to develop a tradition of its own which it transmits to its successive members and upon whose continuance the prospective parties can rely. This element of calculability and stability which is thus introduced into the operations of an international tribunal is in sharp contrast to the haphazard proceedings typical of the arbitration courts before the First World War. It surrounds the Court with an atmosphere of confidence which is something quite novel in the annals of international relations.

### *c) The Effect of Judicial Decisions*

It is true that in so far as this stability and calculability go beyond mere matters of organization they are the psychological result of a permanent organization rather than the effect of legal enactment. Indeed, concerning the legal effect of the judicial pronouncements of the Court, the Statute pays tribute to the principle of decentralization by providing in Article 59 that "the decision of the Court has no binding force except between the parties and in respect of that particular case." Although the social fact of the continuing operation of the same persons within one organization is conducive

## The Main Problems of International Law

to the development of uniformity and of a tradition in the jurisprudence of the Court, the latter is under no legal duty, as the Anglo-American courts are, to follow the rule of *stare decisis* and to justify its decisions in the light of precedent. Nevertheless, because of the social pressure for uniformity discussed above, the jurisprudence of the Court during the first two decades of its existence would hardly have been different even if the Court actually had been bound by the rule of *stare decisis*. Nevertheless, the Court was and remains free to disregard its previous decisions should it so choose, and situations may arise where a court bound by the rule of *stare decisis* would hesitate to disregard its previous decisions, while the International Court of Justice might not.

This element of uncertainty within the jurisprudence of the International Court of Justice itself is, however, small in comparison with the one which, by virtue of Article 59 of the Statute, affects the relations between the jurisprudence of the Court and the many and heterogeneous other judicial agencies operating in the international field. The strength of the national systems of adjudication as a means of putting effective restraints upon the actions of the individual citizens derives in large part from the hierarchical nature of that system. Whatever act the individual citizen may perform, a court stands ready to say whether or not the act meets the requirements of the law. When these courts have spoken, a higher court can be appealed to in order to approve or disapprove the decision of the lower court. And, finally, a supreme court will state with ultimate authority the law in the case. Since all these courts operate under the rule of *stare decisis*, their decisions are logically consistent with each other not only within the same court, but also within the whole system of courts. The hierarchical character of their relations guarantees the uniformity of the decisions throughout the system.<sup>25</sup> The combination of hierarchical organization and of the rule of *stare decisis*, then, produces one system of jurisprudence throughout the judicial system, one body of coherent law ever ready to go into action at the request of whoever claims to need the protection of the law.

Nothing in the international sphere even remotely resembles this situation. The International Court of Justice is the one court which has potentially world-wide jurisdiction. But the multitude of other courts, created by special treaties for particular parties, for special types of disputes, or for specific single cases, have no legal connection at all either with each other or with the International Court of Justice. The International Court of Justice is in no sense a supreme court of the world which might decide, with final authority, appeals from the decisions of other international tribunals. It is but one international court among many others, outstanding through the permanency of

---

<sup>25</sup> This is true only ideally; it suffers exceptions in the actual operation of the domestic judicial systems. In the federal judicial system, for example, logical consistency of the decisions of the different federal courts is assured only in so far as the Supreme Court has and takes jurisdiction as the highest court of appeals. Where, either by law or because the Supreme Court refuses to grant *certiorari*, the several Circuit Courts of Appeals decide similar cases without recourse to a higher tribunal, the legal rules applied by them to similar cases may, and frequently do, differ from each other. To this extent, then, there exists within the federal judicial system an exceptional situation which is rather normal in the realm of international adjudication.

## *Politics among Nations*

its organization, the potential reach of its jurisdiction, and the generally high legal quality of its predecessor's decisions. Yet in no sense is it hierarchically superimposed upon the other international courts. The decisions of the Permanent Court of International Justice and of its successor may, by virtue of their professional excellence, put their imprint upon the decisions of other international courts. But, since they are not bound by the rule of *stare decisis*, other international courts are no more under the legal obligation to make their decisions consistent with the decisions of the International Court of Justice than they are to make their own decisions consistent with each other. Here again, decentralization is the earmark of the judicial function in the international field.

### 4. THE ENFORCEMENT OF INTERNATIONAL LAW

#### a) *Its Decentralized Character*

What for the legislative and judicial functions required elaborate proof is clear for all to see in the case of the executive function: its complete and unqualified decentralization. International law does not even provide for agencies and instrumentalities for the purpose of its enforcement apart from the agencies and instrumentalities of the national governments. Professor Brierly describes the situation thus:

The international system does not directly provide for the exercise of the executive function of government. It has no central organ with a duty to see that international law is observed, and no instruments in the shape of an army or police force to enforce its observance. . . . This absence of an executive power means that each state remains free . . . to take such action as it thinks fit to enforce its own rights. This does not mean that international law has no sanction, if that word is used in its proper sense of means for securing the observance of the law; but it is true that the sanctions which it possesses are not systematic or centrally directed, and that accordingly they are precarious in their operation.<sup>20</sup>

In the same sense in which the individual state is its own legislator and the creator of its own tribunals and of their jurisdiction, it is also its own sheriff and policeman. When individual A violates the rights of individual B within the national community, the law enforcement agencies of this state will intervene and protect B against A and force A to give B satisfaction according to the law. Nothing of the kind exists in the international sphere. If State A violates the rights of State B, no enforcement agency will come to the support of B. B has the right to help itself if it can, that is to say, if it is strong enough in comparison with A to meet the infringement of its rights with enforcement actions of its own. Only under very exceptional and narrow conditions, in the forms of self-help and self-defense, does domestic law give the victim of a violation of the law the right to take the law into his own hands and enforce it against the violator. What is a narrowly circumscribed exception in domestic law is the principle of law enforcement in international law. Ac-

<sup>20</sup> *The Law of Nations*, pp. 71, 72. (Reprinted by permission of The Clarendon Press, Oxford.)



## *The Main Problems of International Law*

ording to this principle, the victim, and nobody but the victim, of a violation of the law has the *right* to enforce the law against the violator. Nobody at all has the *obligation* to enforce it.

There can be no more primitive and no weaker system of law enforcement than this; for it delivers the enforcement of the law to the vicissitudes of the distribution of power between the violator of the law and the victim of the violation. It puts a premium upon the violation of the law as well as upon the enforcement of the law by the strong and, consequently, puts the rights of the weak in jeopardy. A great power can violate the rights of a small nation without having to fear effective sanctions on the latter's part. It can afford to proceed against the small nation with measures of enforcement under the pretext of a violation of its rights, regardless of whether the alleged infraction of international law has actually occurred or whether it justifies the measures taken.

The small nation must look for the protection of its rights to the assistance of powerful friends which can marshal superior power in order to oppose an attempt at infringement with a chance of success. Whether such assistance will be forthcoming is not a matter of international law, but of the national interest as conceived by the individual nations which must decide whether or not to come to the support of the weak member of the international community. In other words, whether or not an attempt will be made to enforce international law and whether or not the attempt will be successful do not depend primarily upon legal considerations and the disinterested operation of law-enforcing mechanisms. Both attempt and success depend upon political considerations and the actual distribution of power in a particular case. The protection of the rights of a weak nation, threatened by a strong one, is then determined by the balance of power as it operates in that particular situation. Thus the rights of Belgium were safeguarded in 1914 against their violation by Germany, for it so happened that the protection of those rights seemed to be required by the national interests of powerful neighbors. On the other hand, the rights of Colombia, when the United States supported the revolution in 1903 which led to the establishment of the Republic of Panama, and the rights of Finland, when attacked by the Soviet Union in 1939, were violated either with impunity or, as in the case of Finland, without the intervention of effective sanctions. There was no balance of power which could have protected these nations.

It must be pointed out, however, that the actual situation is much less dismal than the foregoing analysis might suggest. The great majority of the rules of international law are generally observed by all states without actual compulsion, for it is generally in the interest of all states concerned to honor their obligations under international law. A state will hesitate to infringe upon the rights of foreign diplomats residing in its capital; for it has an interest, identical with the interests of all other states, in the universal observance of the rules of international law which extend their protection to its own diplomatic representatives in foreign capitals as well as to the foreign diplomats in its own capital. A state will likewise be reluctant to disregard its obligations under a commercial treaty, since the benefits which it expects from its execution by the other contracting parties are complementary to those

## *Politics among Nations*

anticipated by the latter. It may thus stand to lose more than it would gain by not fulfilling its part of the bargain. This is particularly so in the long run, since a state which has the reputation of renegeing on its commercial obligations will find it hard to conclude commercial treaties beneficial to itself.

Most rules of international law formulate in legal terms such identical or complementary interests. It is for this reason that they generally enforce themselves, as it were, and that there is generally no need for a specific enforcement action. In most cases in which such rules of international law are actually violated despite the underlying community of interests, satisfaction is given to the wronged party either voluntarily or in consequence of adjudication. And it is worthy of note that of the thousands of such judicial decisions which have been rendered in the last century and a half, voluntary execution was refused by the losing party in fewer than ten cases.

Thus the great majority of rules of international law are generally unaffected by the weakness of its system of enforcement, for voluntary compliance prevents the problem of enforcement from arising altogether. The problem of enforcement becomes acute, however, in that minority of important and generally spectacular cases, particularly important in the context of our discussion, in which compliance with international law and its enforcement have a direct bearing upon the relative power of the nations concerned. In those cases, as we have seen, considerations of power rather than of law determine compliance and enforcement. Two attempts have been made to remedy this situation and to give the executive function in international law at least a semblance of objectivity and centralization. Both attempts have failed, and for the same reason. One attempt, in the form of international guarantee, can be traced to the beginning of the modern state system; the other, collective security, was first undertaken by the Covenant of the League of Nations.

### *b) Treaties of Guaranty*

Taught by sad experience that the sacred and inviolable duty of fidelity to treaties is not always a safe assurance that they will be observed, men have sought to obtain securities against perfidy, means for enforcing observance independently of the good faith of the contracting parties. A guaranty is one of these means. When those who conclude a treaty of peace, or any other treaty, are not absolutely confident of its observance they ask to have it guaranteed by a powerful sovereign. The guarantor promises to uphold the terms of the treaty and to procure their observance. As he may find himself obliged to use force, if either of the contracting parties should try to avoid the fulfillment of its promises, the position of guarantor is one which no sovereign will assume lightly or without good reasons. Princes seldom do so unless they have an indirect interest in the observance of the treaty or are induced by motives of friendship.<sup>27</sup>

This statement by Vattel defines well the motives and the legal content of treaties of guaranty and does not fail to allude to their problematical nature as substitutes for a truly centralized organization of international law enforcement.

<sup>27</sup> Emerich de Vattel, *The Law of Nations* (Washington: Carnegie Institution, 1916), book II, § 235, p. 193.

## The Main Problems of International Law

The simplest type of a treaty of guaranty is exemplified by what is generally considered to be the earliest such treaty in modern history: the Treaty of Blois of 1505 between France and Aragon, guaranteed by England. This guaranty signified that England took upon itself the legal obligation to perform the task of the policeman with regard to the execution of this treaty, promising to see that both parties remained faithful to it.

A more advanced type of international guaranty is to be found, for instance, in the guaranty of the territorial integrity of Turkey by the signatories of the Treaty of Paris of 1856 and of the Treaty of Berlin of 1878, and in the guaranty of the neutrality of Belgium and Luxembourg by the signatories of the treaties of 1831 and 1839, and 1867, respectively. In the Treaty of Mutual Guarantee of October 16, 1925, which forms part of the so-called Locarno Pact, Great Britain, Belgium, France, Germany, and Italy "collectively and severally guarantee . . . the maintenance of the *status quo* resulting from the frontiers between Germany and Belgium, and between Germany and France, and the inviolability of the said frontiers." In this type of treaty of guaranty not one but a group of nations, generally most, if not all of the great powers, pledge themselves, either severally or collectively, to enforce the legal provisions which they have guaranteed against whomever tries to infringe upon them.

In order to be able to fulfill their function as a substitute for centralized executive agencies, both types of treaties must meet two prerequisites: they must be effective in their execution, and the execution must be automatic. The effectiveness of the execution, however, is again a function of the balance of power, that is to say, it depends upon the distribution of power between the guarantor nations and the lawbreaker. The distribution of power may favor the guarantor nations, especially in the case of collective guaranty, but not necessarily so. Particularly under modern conditions of warfare, situations can easily be visualized in which one lawbreaking great power will be able to withstand the united pressure of a great number of law-abiding guarantor nations.

Yet it is the uncertainty in applying the guaranty which vitiates its effectiveness altogether. The authoritative textbook of international law has aptly pointed to the many loopholes through which a guarantor is able to evade the execution of the treaty without violating it. We read in Oppenheim-Lauterpacht:

But the duty of the guarantors to render . . . the promised assistance to the guaranteed State depends upon many conditions and circumstances. Thus, first, the guaranteed State must request the guarantor to render assistance. Thus, secondly, the guarantor must at the critical time be able to render the required assistance. When, for instance, its hands are tied through waging war against a third State, or when it is so weak through internal troubles, or other factors, that its interference would expose it to a serious danger, it is not bound to fulfil the request for assistance. So too, when the guaranteed State has not complied with previous advice given by the guarantor as to the line of its behaviour, it is not the guarantor's duty to render assistance afterwards.<sup>28</sup>

---

<sup>28</sup> *International Law*, I, 870-1. (Reprinted by permission of Longmans, Green & Co., Inc.)

## *Politics among Nations*

In other words, the obligation to guarantee compliance with international law through enforcement actions is no more stringent—and, if possible, rather less so—than the obligation to submit disputes to adjudication by an international court. In both cases the obligation is rendered virtually valueless by qualifications, reservations, and exceptions, covering all possible contingencies. Treaties of guaranty leave the executive function in the international field for all practical purposes as decentralized as it would be without them.

### *c) Collective Security*

Collective security is the most far-reaching attempt on record to overcome the deficiencies of a completely decentralized system of law enforcement. While traditional international law leaves the enforcement of its rules to the injured state, collective security envisages the enforcement of the rules of international law by all the members of the community of nations, whether or not they have suffered injury in the particular case. The prospective law-breaker, then, must always expect to face a common front of all nations, automatically taking collective action in defense of international law. As an ideal, collective security is without flaw; it presents indeed the ideal solution of the problem of law enforcement in a community of sovereign states. However, the two attempts which have been made to put the idea of collective security into practice—Article 16 of the Covenant of the League of Nations and Chapter VII of the Charter of the United Nations—fall far short of the ideal. In turn, the actual practice of the members of these two organizations has fallen far short of the collective measures authorized by those two documents.

ARTICLE 16 OF THE COVENANT OF THE LEAGUE OF NATIONS. While the Covenant of the League of Nations today has only historic interest, the first three paragraphs of its Article 16<sup>20</sup> remain the pioneering attempt at putting a system of collective security into effect and, furthermore, the only one which thus far actually has been put into effect. The system of collective security provided for in these three paragraphs is from the outset limited to one type

<sup>20</sup> Article 16 of the Covenant of the League of Nations reads:

1. Should any Member of the League resort to war in disregard of its covenants under Articles 12, 13 or 15, it shall *ipso facto* be deemed to have committed an act of war against all other Members of the League, which hereby undertake immediately to subject it to the severance of all trade or financial relations, the prohibition of all intercourse between their nationals and the nationals of the covenant-breaking State, and the prevention of all financial, commercial or personal intercourse between the nationals of the covenant-breaking State and the nationals of any other State, whether a Member of the League or not.

2. It shall be the duty of the Council in such case to recommend to the several Governments concerned what effective military, naval or air force the Members of the League shall severally contribute to the armed forces to be used to protect the covenants of the League.

3. The Members of the League agree, further, that they will mutually support one another in the financial and economic measures which are taken under this Article, in order to minimise the loss and inconvenience resulting from the above measures, and that they will mutually support one another in resisting any special measures aimed at one of their number by the covenant-breaking State, and that they will take the necessary steps to afford passage through their territory to the forces of any of the Members of the League which are cooperating to protect the covenants of the League.

4. Any Member of the League which has violated any covenant of the League may be declared to be no longer a Member of the League by a vote of the Council concurred in by the Representatives of all the other Members of the League represented thereon.

## *The Main Problems of International Law*

of violation of international law, that is, resort to war in violation of the provisions for the peaceful settlement of international disputes laid down in Articles 12, 13, and 15 of the Covenant.<sup>30</sup> For all other violations of inter-

<sup>30</sup> Articles 12, 13, and 15 read:

### *Article 12*

1. The Members of the League agree that if there should arise between them any dispute likely to lead to a rupture they will submit the matter either to arbitration or judicial settlement or to enquiry by the Council, and they agree in no case to resort to war until three months after the award by the arbitrators or the judicial decision or the report by the Council.

2. In any case under this Article the award of the arbitrators or the judicial decision shall be made within a reasonable time, and the report of the Council shall be made within six months after the submission of the dispute.

### *Article 13*

1. The Members of the League agree that whenever any dispute shall arise between them which they recognise to be suitable for submission to arbitration or judicial settlement, and which cannot be satisfactorily settled by diplomacy, they will submit the whole subject-matter to arbitration or judicial settlement.

2. Disputes as to the interpretation of a treaty, as to any question of international law, as to the existence of any fact which, it established, would constitute a breach of any international obligation, or as to the extent and nature of the reparation to be made for any such breach, are declared to be among those which are generally suitable for submission to arbitration or judicial settlement.

3. For the consideration of any such dispute, the court to which the case is referred shall be the Permanent Court of International Justice, established in accordance with Article 14, or any tribunal agreed on by the parties to the dispute or stipulated in any convention existing between them.

4. The Members of the League agree that they will carry out in full good faith any award or decision that may be rendered, and that they will not resort to war against a Member of the League which complies therewith. In the event of any failure to carry out such an award or decision, the Council shall propose what steps should be taken to give effect thereto.

### *Article 15*

1. If there should arise between Members of the League any dispute likely to lead to a rupture, which is not submitted to arbitration or judicial settlement in accordance with Article 13, the Members of the League agree that they will submit the matter to the Council. Any party to the dispute may effect such submission by giving notice of the existence of the dispute to the Secretary-General, who will make all necessary arrangements for a full investigation and consideration thereof.

2. For this purpose, the parties to the dispute will communicate to the Secretary-General, as promptly as possible, statements of their case with all the relevant facts and papers, and the Council may forthwith direct the publication thereof.

3. The Council shall endeavor to effect a settlement of the dispute, and if such efforts are successful, a statement shall be made public giving such facts and explanations regarding the dispute and the terms of settlement thereof as the Council may deem appropriate.

4. If the dispute is not thus settled, the Council either unanimously or by a majority vote shall make and publish a report containing a statement of the facts of the dispute and the recommendations which are deemed just and proper in regard thereto.

5. Any Member of the League represented on the Council may make public a statement of the facts of the dispute and of its conclusions regarding the same.

6. If a report by the Council is unanimously agreed to by the members thereof other than the Representatives of one or more of the parties to the dispute, the Members of the League agree that they will not go to war with any party to the dispute which complies with the recommendations of the report.

7. If the Council fails to reach a report which is unanimously agreed to by the members thereof, other than the Representatives of one or more of the parties to the dispute, the Members of the League reserve to themselves the right to take such action as they shall consider necessary for the maintenance of right and justice.

8. If the dispute between the parties is claimed by one of them, and is found by the Council, to arise out of a matter which by international law is solely within the domestic jurisdiction of that party, the Council shall so report, and shall make no recommendation as to its settlement.

9. The Council may in any case under this Article refer the dispute to the Assembly. The dispute shall be so referred at the request of either party to the dispute provided that such request be made within fourteen days after the submission of the dispute to the Council.

## *Politics among Nations*

national law only the individualized, decentralized system of enforcement provided for by general international law is available.

The violations of international law which put the first three paragraphs of Article 16 into operation create the following four legal effects: (1) The law-breaking state "is deemed to have committed an act of war against all other members of the League." (2) The latter are under the legal obligation to isolate the lawbreaking state, through a complete boycott, from any kind of intercourse with any other member of the community of nations. (3) The Council of the League is under the legal obligation to recommend to the member states the military contribution to be made by them for the defense of the violated provisions of the Covenant. (4) The members of the League are under the legal obligation to give each other all economic and military assistance in the execution of the collective action.

While the literal text of these provisions seems to create automatic obligations of a collective character with respect to points (1), (2), and (4), it limits itself with regard to point (3), which obviously is the most important, to a recommendation which, as such, the member states must be free either to accept or to reject at their discretion. Yet the appearances of points (1), (2), and (4) are deceptive. The interpretative Resolutions, accepted by the Assembly of the League in 1921 and generally considered to be authoritative in fact, if not in law, have virtually eliminated the compulsory and automatic elements of Article 16 and have reduced the apparent obligations of the text to mere recommendations supported by nothing but the moral authority of the Council of the League.<sup>31</sup>

10. In any case referred to the Assembly, all the provisions of this Article and of Article 12 relating to the action and powers of the Council shall apply to the action and powers of the Assembly, provided that a report made by the Assembly, if concurred in by the Representatives of those Members of the League represented on the Council and of a majority of the other Members of the League, exclusive in each case of the Representatives of the parties to the dispute, shall have the same force as a report by the Council concurred in by all the members thereof other than the Representatives of one or more of the parties to the dispute.

<sup>31</sup> The relevant Resolutions read as follows:

3. The unilateral action of the defaulting State cannot create a state of war; it merely entitles the other Members of the League to resort to acts of war or to declare themselves in a state of war with the covenant-breaking State; but it is in accordance with the spirit of the Covenant that the League of Nations should attempt, at least at the outset, to avoid war, and to restore peace by economic pressure.

4. It is the duty of each Member of the League to decide for itself whether a breach of the Covenant has been committed. The fulfilment of their duties under Article 16 is required from Members of the League by the express terms of the Covenant, and they cannot neglect them without breach of their Treaty obligations.

9. All States must be treated alike as regards the application of the measures of economic pressure, with the following reservations:

(a) It may be necessary to recommend the execution of special measures by certain states;

(b) If it is thought desirable to postpone, wholly or partially, in the case of certain States, the effective application of the economic sanctions laid down in Article 16, such postponement shall not be permitted except in so far as it is desirable for the success of the common plan of action, or reduces to a minimum the losses and embarrassments which may be entailed in the case of certain Members of the League by the application of the sanctions.

10. It is not possible to decide beforehand, and in detail, the various measures of an economic, commercial and financial nature to be taken in each case where economic pressure is to be applied. When the case arises, the Council shall recommend to the Members of the League a plan for joint action.

11. The interruption of diplomatic relations may, in the first place, be limited to the withdrawal of the heads of Missions.

12. Consular relations may possibly be maintained.

## *The Main Problems of International Law*

First of all, the Resolutions, in contrast to the apparent purport of Article 16, establish the individualized, decentralized character of the League sanctions by declaring it to be the duty of each individual member state to decide for itself whether a violation of international law has been committed and whether, therefore, Article 16 ought to apply at all. Furthermore, as interpreted by the Resolutions point (1) authorizes the members of the League to resort to war with the lawbreaking state, but does not create, as the literal meaning would indicate, a legal obligation in this respect. As regards points (2) and (4), the Resolutions leave to the individual states the decision as to what measures they want to take against the lawbreaker and in support of each other. The Council acts as a mere co-ordinating agency with the power to make recommendations as to what measures ought to be taken, at what time, and by what states, but without authority to bind the individual members against their will.

In sum, while the obligation to take action under Article 16 remains decentralized, the actions decided upon by the individual states are to be executed under the centralized direction of the Council of the League. The Resolutions take a forward step in centralizing the technique of enforcement action decided upon by a number of individual states. But, with respect to the compulsory and automatic character of the enforcement action, they fulfill the same function which reservations perform for compulsory adjudication and which exceptions and qualifications perform for treaties of guaranty—they reduce to the vanishing point the compulsory character of what purports to be a legal obligation.

The reformulation of Article 16 by the Assembly Resolutions amounts to the reaffirmation of the decentralized character of law enforcement. The practice of the League of Nations demonstrates the reluctance of the member states to avail themselves even of the limited opportunities for the centralized execution of sanctions which the reformulated Article 16 offers. Article 16 was applied in only one of the five cases in which undoubtedly a member of the League resorted to war in violation of the Covenant. With regard to the Sino-Japanese conflict which started in 1931, the Assembly of the League of Nations found unanimously that "without any declaration of war, part of the Chinese territory has been forcibly seized and occupied by the Japanese troops,"<sup>82</sup> and that far-flung hostilities, initiated by Japan, had taken place between troops of the Chinese and Japanese governments. Yet the Assembly

---

13. For the purposes of the severance of relations between persons belonging to the covenant-breaking State and persons belonging to other States Members of the League, the test shall be residence and not nationality.

14. In cases of prolonged application of economic pressure, measures of increasing stringency may be taken. The cutting off of the food supplies of the civil population of the defaulting State shall be regarded as an extremely drastic measure which shall only be applied if the other measures available are clearly inadequate.

15. Correspondence and all other methods of communication shall be subjected to special regulations.

16. Humanitarian relations shall be continued.

For the complete text, see League of Nations *Official Journal*, Special Supplement No. 6 (October 1921), pp. 24 ff.

<sup>82</sup> "League of Nations Assembly Report on the Sino-Japanese Dispute," *American Journal of International Law*, Vol. 27 (1933), Supplement, p. 146.

## *Politics among Nations*

found also that Japan had not resorted to war in violation of the Covenant and that, therefore, Article 16 did not apply.

In 1934, during the Chaco War of 1932-35, when Paraguay continued hostilities against Bolivia in violation of the Covenant, many members of the League limited the arms embargo, originally imposed upon both belligerents, to Paraguay. This was a discriminatory measure falling far short of the spirit and the letter of the first paragraph of Article 16. When Japan, which by then had resigned from the League, invaded China in 1937, the Assembly found that Japan had violated the Nine Power Treaty of 1922 and the Briand-Kellogg Pact, that Article 16 was applicable, and that the members of the League had the right to taken enforcement measures individually under that provision. No such measures were ever taken. When the Soviet Union went to war with Finland in 1939, it was expelled from the League by virtue of Article 16, paragraph 4, but no collective action of enforcement was taken against it.

In contrast to these cases, the Assembly found in 1935 that the invasion of Ethiopia by Italy constituted resort to war within the meaning and in violation of the Covenant and that, therefore, Article 16, paragraph 1, was to apply. In consequence, collective economic sanctions against Italy were decided upon and applied. Yet the two measures, provided for by Article 16, paragraph 1, which offered the best chance of making international law prevail under the circumstances and which in all probability would have compelled Italy to desist from its attack upon Ethiopia, namely, an embargo on oil shipments to Italy and the closure of the Suez Canal, were not taken. "However," as Professor Lauterpacht puts it, "although the sanctions of Article 16, paragraph 1, were formally put into operation and although an elaborate machinery was set up with a view to their successive and gradual enforcement, the nature of the action taken was such as to suggest that the repressive measures were being adopted as a manifestation of moral reprobation rather than as an effective means of coercion."<sup>83</sup>

One can, therefore, sum up the attempts at establishing a centralized system of law enforcement under Article 16 of the Covenant by saying that in most of the cases which would have justified the application of sanctions, sanctions were not applied at all. In the sole case in which they were applied, they were applied in such an ineffective fashion as virtually to assure both their failure and the success of the recalcitrant state.

CHAPTER VII OF THE CHARTER OF THE UNITED NATIONS. Chapter VII of the Charter of the United Nations, comprising Articles 39-51, constitutes the counterpart to Article 16 of the Covenant of the League of Nations as the attempt to overcome the weakness of a decentralized system of international law enforcement. As such, it takes a long step toward the establishment of a centralized law-enforcement agency. Articles 39, 41, and 42 of the Charter, which are the heart of the United Nations system of law enforcement, go far beyond anything that either the Covenant of the League of Nations or any other source of international law has contemplated. They are, however, subject to

---

<sup>83</sup> Oppenheim-Lauterpacht, *International Law* (6th Ed. 1944), II, 139, 140. (Reprinted by permission of Longmans, Green & Co., Inc.)



## *The Main Problems of International Law*

three important qualifications and exceptions which, as we shall see, limit and under certain conditions even nullify the centralization of law enforcement for which the text of those articles provides.

The Covenant of the League of Nations leaves it to the individual nations to decide whether the Covenant has been violated. Resolution 4, interpreting Article 16 of the Covenant, reads: "It is the duty of each member of the League to decide for himself whether a breach of the Covenant has been committed." According to Resolution 6, the Council of the League renders no decision in this matter, but only a recommendation with nothing more than moral authority. In contrast, Article 39 of the Charter of the United Nations reads: "The Security Council shall determine the existence of any threat to the peace, breach of the peace, or act of aggression and shall . . . decide what measures shall be taken in accordance with Articles 41 and 42 to maintain or restore international peace and security." It is the Security Council, and not the individual member states, which decides authoritatively in what situations measures of enforcement are to be taken. Such a decision is not a recommendation whose execution depends upon the discretion of the individual member states, but is binding upon the latter which in Article 25 of the Charter "agree to accept and carry out the decisions of the Security Council in accordance with the present Charter."

It is the same kind of binding, authoritative decision on the part of the Security Council which determines the enforcement action to be applied in a particular case, and here again the discretion of the individual member states does not enter into the picture at all. With respect to economic sanctions dealt with in Article 41, it is the Security Council which may "decide" and "call upon" the members to comply with its decisions. With respect to military sanctions, provided for in Article 42, it is the Security Council which "may take . . . action." In order to make military action on the part of the Security Council possible, Article 43 imposes upon the member states the obligation "to make available to the Security Council . . . armed forces, assistance, and facilities . . . necessary for the purpose of maintaining international peace and security," and Article 45 emphasizes this obligation especially with respect to air-force contingents "for combined international enforcement action." These obligations are to be discharged by way of agreements between the member states and the Security Council. The agreements shall determine "the numbers and types of forces, their degree of readiness and general location, and the nature of the facilities and assistance to be provided."

These agreements present the sole decentralized element in the enforcement scheme of Chapter VII of the Charter; for, by refusing to agree to more than a modest contribution to the military effort of the Security Council, a nation is in a position to limit correspondingly its subsequent subordination under the decisions of the Security Council. Or by withholding agreement altogether, it may evade completely the obligation to partake in military enforcement actions decided upon by the Security Council. In other words, the military factor of the enforcement mechanism of Chapter VII can be put into existence and operation only under the condition that the individual member states agree individually to allow it to exist and operate. Once the military

## *Politics among Nations*

contingents have been created by individual agreements, the Security Council reigns supreme, and the discretionary power of the contracting nations has come to an end, at least within the limits of the law of the Charter.

Actually the member states are still able, even after the conclusion of the agreements, to refuse, in violation of their obligation under Article 43, to heed the "call" of the Security Council and to make available to it the contingents and military facilities agreed upon. They can thus make the Security Council powerless to act. This, however, would be a kind of "mutiny" and as such an illegal act, the possibility of which all military establishments must take into account. Unlike other military establishments, however, the military establishment of the United Nations faces the possibility of not coming into existence at all if the subjects of the law do not take it upon themselves through voluntary agreements to bring it into existence.

At the moment of this writing, no agreement under Article 43 has been concluded or even started to be negotiated. Hence, the provisions of the Charter relative to military measures of law enforcement have thus far remained a dead letter. In consequence, Article 106 of the Charter applies. This article provides that in the absence of such agreements the United States, Great Britain, the Soviet Union, China, and France shall "consult with one another and as occasion requires with other members of the United Nations with a view to such joint action on behalf of the organization as may be necessary for the purpose of maintaining international peace and security." With this the Charter of the United Nations reverts to the decentralization of the use of force to be found in Article 16 of the Covenant of the League of Nations and in common international law. Thus the will of the individual states, that is, decentralization, which we found at the foundation of international law with regard to legislation and adjudication, is at present still of the essence of law enforcement, in so far as the existence of the military establishment of the United Nations and, in its absence, the use of force in defense of the Charter are concerned.

This qualification of the enforcement system of Chapter VII of the Charter of the United Nations is not necessarily of an organic nature, for it will automatically become immaterial if and when the agreements of which Article 42 speaks will have been concluded. The Charter contains, however, two provisions which are of a different nature. Their operation is not dependent upon a contingency, such as the one envisaged by Article 106. They limit the operation of the enforcement system of Chapter VII necessarily and permanently. One is Article 51, the other is to be found in Article 27, paragraph 3.

Article 51 stipulates that "nothing in the present Charter shall impair the inherent right of individual or collective self-defense if an armed attack occurs against a member of the United Nations." Individual self-defense as the right, in the absence of the law-enforcement agent of the state, to meet an attack with commensurate force is an exception to centralized law enforcement, inherent in all legal systems, domestic or international. It would limit the law-enforcement mechanism of the United Nations even though it were not expressly recognized by Article 51. It is different with collective self-defense which is a newcomer to legal terminology and might even be considered a contradiction in terms. What Article 51 obviously aims at is the recognition of

## *The Main Problems of International Law*

the right of any state, whether directly attacked or not, to come to the aid of any state which has been so attacked. This is, however, tantamount to the reaffirmation of the traditional principle of common international law: it is for the injured state to enforce international law against the lawbreaker, and that state can rely only upon the voluntary co-operation of other states to make international law prevail. It is the reaffirmation, as far as a violation of international law takes the form of an armed attack, of the decentralization of law enforcement, not only for the immediately injured state, but for all other states as well.

It is true that Article 51 subjects this reaffirmation to three qualifications. They are, however, of a verbal rather than a substantive nature. First, the right of collective self-defense shall remain unimpaired only "until the Security Council has taken the measures necessary to maintain international peace and security." Second, measures taken in collective self-defense have to be reported immediately to the Security Council. And, third, such measures shall not affect the authority and responsibility of the Security Council to take appropriate action itself.

While the second qualification is obviously redundant since it will duplicate the information which the Security Council must have already received through press, radio, and ordinary diplomatic channels, the other two qualifications are, in view of the situations likely to occur, virtually devoid of practical importance. An armed attack of A against B, to whose assistance C, D, and E come with their air, land, and naval forces, confronts the Security Council, especially under the conditions of modern warfare, with an accomplished fact to which it must adapt its enforcement measures. Air attacks will have been executed, battles will have been fought, territories will have been occupied, that is to say, a full-fledged war will have started by virtue of the right of collective self-defense. The Security Council, far from being able to stop that war and substitute for it its own enforcement measures, can only participate in it on terms which will necessarily be subordinated to the strategy of the individual belligerent states already engaged in full-scale hostilities. Once started as a measure of collective self-defense, a coalition war may receive the legal and political blessings and the active support of the United Nations. But it will hardly lose its initial character and be transformed into an enforcement action under the actual guidance of the Security Council.

**THE VETO.** The real crux of the enforcement system of the United Nations, affecting every action to be taken by the Security Council under the provisions of Chapter VII, is Article 27, paragraph 3, of the Charter. It stipulates that "decisions of the Security Council . . . shall be made by an affirmative vote of seven members including the concurring votes of the permanent members." The permanent members, according to Article 23, are China, France, Great Britain, the Soviet Union, and the United States. This means that the consent of all five permanent members is needed for putting the enforcement machinery of Chapter VII into effect. Dissent by one of the permanent members is sufficient to make the execution of any enforcement measure impossible even when all the other ten members of the Security Council have consented. In other words, each of the permanent members has a

## *Politics among Nations*

veto with regard to any enforcement measure to be taken in pursuance of Chapter VII of the Charter.

Thus the veto reintroduces into the system of law enforcement of the United Nations the principle of decentralization by making the operation of the system dependent upon the will of each of the permanent members. The provisions of Chapter VII which, as we have seen, constitute in themselves an important step toward the centralization of law enforcement in the international field, must be read in the light of Article 27, paragraph 3, which deprives them of much of their centralizing effect. More particularly, it incapacitates them for the performance of the function which concerns us here above all, namely, the imposition of effective restraints upon the struggle for power on the international scene. Three consequences of the veto are in this respect especially worthy of note.

First of all, the veto eliminates any possibility of centralized measures of law enforcement being applied against any of the permanent members. A permanent member as the prospective victim of such enforcement measures would simply veto the determination, required of the Security Council by Article 39, that "any threat to the peace, breach of the peace, or act of aggression" exists and that, therefore, any legal grounds exist for the application of enforcement measures. Even the raising of the issue of such measures would thus be precluded.

Second, if in view of Article 27, paragraph 3, the Security Council is capable at all of putting the enforcement machinery of the Charter into operation, it can do so only with regard to small and medium powers, that is, those which are not among the permanent members of the Security Council and, hence, cannot make centralized enforcement measures impossible through the veto. Such measures, if they apply at all, apply only to small and medium powers. Yet, in view of the veto of the great powers, they will apply even to the small and medium powers only under rare and extraordinary circumstances. As international politics is constituted today, most of the small and medium powers are intimately aligned with one or the other of the great powers which dominate the international scene. They are very unlikely to commit a breach of international law calling for enforcement measures under Chapter VII of the Charter without the encouragement or, at least, the approval of the great power with which they are aligned. Even if there were no such alignment, any change in the status quo between two small nations anywhere in the world will have direct repercussions upon the relative power positions of the great powers which are the permanent members of the Security Council. The global political and military strategy of our time makes this inevitable.

Whether or not these permanent members will give their unanimous consent to enforcement measures against a medium or small nation will depend, therefore, not so much upon questions of international law as upon the power relations among the permanent members. If the latter are not pitted against each other in actual power contests, they might agree upon centralized enforcement measures. For, then, they can envisage with relative equanimity any future change in the power relations between the two quarreling nations. Whenever, on the other hand, two or more permanent members are actively

## *The Main Problems of International Law*

engaged in the competition for power and, hence, when such enforcement measures will have a direct bearing upon their power positions, the unanimous consent of the permanent members will be impossible to obtain. By consenting to enforcement measures, at least one permanent member will weaken its own power position by weakening that of its friend and ally, that is, the prospective victim of enforcement measures. That permanent member would have to take a stand against what it considers its own national interest. Such an eventuality must, of course, be discounted. Under any circumstances, putting into operation the centralized enforcement measures of Chapter VII depends upon the discretion of the permanent members of the Security Council, acting as individuals. The centralization of law enforcement, in large measure achieved by Chapter VII, is, therefore, largely nullified by Article 27, paragraph 3.

Finally, the veto eliminates for all practical purposes the qualifications by which Article 51 endeavors to subordinate the right of collective self-defense to the centralized enforcement system of Chapter VII. For it is hard to envisage a case of collective resistance to aggression by a number of nations in which not at least one of the permanent members of the Security Council is involved on one or the other side. Under such circumstances, however, the requirement of unanimity of the permanent members according to Article 27, paragraph 3, either prevents the Security Council from taking any action, in which case the decentralized measures of self-defense will prevail as though the United Nations did not exist, or else vouchsafes the approval by the Security Council of the decentralized measures taken. In either case, the threat or the actuality of the veto will make it impossible for the Security Council to take centralized enforcement measures independently in the presence of decentralized measures already taken.

The picture which the Charter of the United Nations presents to us is, therefore, different from common international law only in its legal potentialities, hardly to be realized under present world conditions, but not in the actual operation of its system of law enforcement. The most important task of any such system is the imposition of effective restraints upon the struggle for power. This task the United Nations is incapable of performing at all where the need for its performance is greatest, that is, with respect to the great powers. For Article 27, paragraph 3, of the Charter puts the great powers beyond the reach of any enforcement action to be taken by virtue of the Charter. In so far as the other nations are concerned, Articles 51 and 106 of the Charter operate as far-reaching reservations upon the general obligations under Articles 39, 41, and 42. The general political situation, as it affects the relations between the permanent members of the Security Council, in conjunction with Article 27, paragraph 3, incapacitates the latter at present for any action in the field of law enforcement.

The actuality of international law enforcement remains, therefore, just as decentralized under the Charter of the United Nations as we found it to be under the Covenant of the League of Nations and in common international law. Wherever an attempt has been made to give international law the effectiveness of a centralized legal system, reservations, qualifications, and the general political conditions under which nations must act in the modern state

## *Politics among Nations*

system have nullified the legal obligations entered into for the purpose of establishing centralized functions.

No concerted efforts have been made to reform the legislative function of international law. But successive attempts have been made to reform the judicial and executive function. Against each such attempt the decentralized character of international law has reasserted itself. Decentralization, then, seems to be of the essence of international law itself. And the basic principle which makes decentralization inevitable is to be found in the principle of sovereignty.

## CHAPTER XVII

# *Sovereignty*

### I. THE GENERAL NATURE OF SOVEREIGNTY

Denunciations of the principle of sovereignty by those who realize the intimate connection between that principle and the weakness of a decentralized system of international law are much more frequent than a serious endeavor to comprehend its nature and the function it performs for the modern state system. In consequence, despite the brilliant efforts of a few outstanding scholars, there is much confusion about the meaning of the term, about what is and what is not compatible with the sovereignty of a particular nation.

The modern conception of sovereignty was first formulated in the latter part of the sixteenth century with reference to the new phenomenon of the territorial state. It referred in legal terms to the elemental political fact of that age—the appearance of a centralized power which exercised its lawmaking and law-enforcing authority within a certain territory. This power, vested at that time primarily, but not necessarily, in an absolute monarch, was superior to the other forces which made themselves felt in that territory. In the span of a century, it became unchallengeable either from within the territory or from without. In other words, it was supreme.

By the end of the Thirty Years' War, sovereignty as supreme power over a certain territory was a political fact, signifying the victory of the territorial princes over the universal authority of emperor and pope, on the one hand, and over the particularistic aspirations of the feudal barons, on the other. The inhabitant of France found that nobody but the royal power could give him orders and enforce them. This experience of the individual French citizen was duplicated by the experience of the king of England or the king of Spain; that is to say, the supreme authority of the French king within French territory precluded them from exerting any authority of their own within that territory save by leave of the French king himself or by defeating him in war. But if the king of England and the king of Spain had no power in France, they had exclusive power in their own territories.

These political facts, present in the experience of the contemporaries, could not be explained by the medieval theory of the state. The doctrine of sovereignty elevated them into a legal theory and thus gave them both moral approbation and the appearance of legal necessity. The monarch was now su-

## *Politics among Nations*

preme within his territory not only as a matter of political fact, but also as a matter of law. He was the sole source of man-made law, that is, of all positive law, but he was not himself subject to it. He was above the law, *legibus solutus*. His powers were, however, not limitless, for he remained bound by the divine law as it revealed itself in his conscience and as it was manifested in human reason as natural law.

The doctrine of sovereignty has retained its importance throughout the modern period of history, and in the conception of popular sovereignty it has provided the national democratic state with a potent political weapon. Yet it has been also subject to reinterpretations, revisions, and attacks, especially in the field of international law. The source of these doubts and difficulties lies in the fact that the assumption of international law imposing legal restraints upon the individual states seems to be logically incompatible with the assumption of these states being sovereign, that is, being the supreme law-creating and law-enforcing authorities, but not themselves subject to legal restraints. In truth, however, sovereignty is incompatible only with a strong and effective, because centralized, system of international law. It is not at all inconsistent with a decentralized, hence, weak and ineffective, international legal order. For national sovereignty is the very source of that decentralization, weakness, and ineffectiveness.

International law is a decentralized legal order in a dual sense. In the first place, its rules are, as a matter of principle, binding only upon those states which have consented to them. In the second place, many of the rules that are binding by virtue of the consent given are so vague and ambiguous and so qualified by conditions and reservations as to allow the individual states a very great degree of freedom of action whenever they are called upon to comply with a rule of international law. While the latter type of decentralization puts its imprint upon the judicial and executive functions of international law, the former is of paramount importance in the field of legislation.

Only a relatively small number of rules of international law do not owe their existence to the consent of the members of the international community. They are either the logical precondition for the existence of any legal system, such as rules of interpretation and rules providing sanctions, or they are the logical precondition for the existence of a multiple state system, such as the rules delimiting the jurisdiction of individual states. Rules of this kind are binding upon all states regardless of their consent and might be called the common international law or the *jus necessarium* of the modern state system. Their binding force does not affect the sovereignty of the individual nations. Indeed, it makes sovereignty as a legal concept possible. For, without the mutual respect for the territorial jurisdiction of the individual state and without the legal enforcement of that respect, international law and a state system based on it could obviously not exist.

Aside from these few common and necessary rules of international law, each individual state is the highest lawgiving authority, in so far as the rules of international law binding upon it are concerned. No rules of international law are binding upon it but those which it has created for itself through its consent. There is no lawgiving authority above it, for there is no state or group of states which can legislate for it. The decentralization of the



legislative function in international law is, therefore, nothing but the principle of sovereignty as applied to the problem of legislation.

What holds true for the legislative function, only with the qualification just mentioned, applies absolutely to the judicial and executive functions. The individual state remains the supreme authority for deciding whether and under what conditions to submit a dispute to international adjudication, and no other state can summon it before an international court without its consent. Where such consent is given in a general form, reservations make it generally possible to evade the jurisdiction of an international court in a concrete case without violating international law. Here again, decentralization of international adjudication is but another term for national sovereignty in respect to the judicial function.

As concerns sovereignty in the field of law enforcement, two situations must be distinguished. The sovereignty of the state as law-enforcing agent is identical with sovereignty in the judicial field, that is, the ultimate decision as to whether and how to engage in a law-enforcing action lies with the individual state. On the other hand, the sovereignty of the state as the intended object of a law-enforcing action manifests itself in what is called the "impenetrability" of the state. This is another way of saying that on a given territory only one state can have sovereignty, that is, supreme authority, and that no other state has the right to perform governmental acts on its territory without its consent. In consequence, all enforcement actions provided for by international law, short of war, are limited to the exercise of pressure upon the recalcitrant government — such as diplomatic protests, intervention, reprisal, blockade — all of which leave intact the territorial sovereignty of the law-breaking state. War as the extreme form of law enforcement under international law is the only exception to that rule; for it is of the very essence of war to penetrate the territory of the enemy while safeguarding the "impenetrability" of one's own territory, and international law allows the occupying state to exercise sovereign rights in the territory occupied by its military force.

As the complete decentralization of the legislative, judicial, and executive functions are but so many manifestations of sovereignty, so are three other principles of international law synonymous with the concept of sovereignty and are, indeed, the outgrowth of that concept. These principles are independence, equality, and unanimity.

## 2. SYNONYMS OF SOVEREIGNTY: INDEPENDENCE, EQUALITY, UNANIMITY

Independence signifies the particular aspect of the supreme authority of the individual state which consists in the exclusion of the authority of any other state. The statement that the state is the supreme authority, that is, sovereign within a certain territory, logically implies that it is independent and that there is no authority above it. Consequently, each state is free to manage its internal and external affairs according to its discretion, in so far as it is not limited by treaty or what we have called above common international law. The individual state has the right to give itself any constitution it pleases, to

## *Politics among Nations*

enact whatever laws it wishes regardless of their effects upon its own citizens, and to choose any system of administration. It is free to have whatever kind of military establishment it deems necessary for the purposes of its foreign policy which, in turn, it is free to determine as it sees fit.

As independence is, in the absence of treaty stipulations to the contrary, a necessary quality of all states, so the duty to respect that independence is a necessary rule of international law. Unless it is abrogated by treaties, this rule prohibiting intervention addresses itself to all states. Thus, when in recent years the United States and Great Britain intervened in the domestic affairs of a number of Eastern European countries by protesting against certain of their constitutional and judicial practices, they could do so only by invoking certain international treaties which they claimed gave them the right to intervene. These Eastern European states rejected the interventions as contrary to international law. They did so by denying the bearing of treaty stipulations upon their constitutional and judicial practices and by invoking the general rule of international law which prohibits intervention in these practices by other states.

In 1931, the League of Nations intervened against a treaty between Germany and Austria establishing a customs union. This intervention could be justified only by certain treaty stipulations in which Austria had taken it upon itself to do nothing which might jeopardize its independence. In the absence of such special obligations by which Austria itself had limited its freedom of action, it would have been free to conclude whatever treaties it pleased with whatever parties it chose. In view of the purposes of our discussion, it is important to recognize not only the absence, in common international law, of any limitations upon the foreign policies of individual nations, but the positive duty, imposed upon all states by common international law, not to interfere with the other states in the conduct of their foreign affairs.

Equality, too, is nothing but a synonym for sovereignty, pointing to a particular aspect of sovereignty. If all states have supreme authority within their territories, none can be subordinated to any other in the exercise of that authority. No state has the right, in the absence of treaty obligations to the contrary, to tell any other state what laws it should enact and enforce, let alone to enact and enforce them on the latter's territory. Being sovereign, states can have no lawgiving or law-enforcing power above them operating directly on their territory. International law is a law among co-ordinated, not subordinated entities. States are subordinated to international law, but not to each other; that is to say, they are equal. When, therefore, Article 2 of the Charter of the United Nations declares that "the Organization is based on the principle of the sovereign equality of all its members," its redundant language emphasizes the importance it attributes to the principle of sovereignty and its logical corollary, the principle of equality.

From the principle of equality a fundamental rule of international law is derived which is responsible for the decentralization of the legislative and, in a certain measure, of the law-enforcing function: the rule of unanimity. It signifies that with reference to the legislative function all states are equal regardless of their size, population, and power. In any international conference creating new law for the international community, the vote of Panama counts

as much as the vote of the United States, and the votes of both are required to make the new rules of international law binding for both. Were it otherwise, a large and powerful state might be able to use its actual preponderance in representation to impose legal obligations upon a weak and small state without the latter's consent. The powerful state would thus make its own authority supreme within the territory of the small state, destroying the latter's sovereignty. Under all circumstances, the rule of unanimity gives each state participating in the deliberations the right to decide for itself whether it wants to be bound by the decision. Whenever the consent of all participating states is required in order to give legal validity to the decision, each state has a right to veto the decision altogether by voting against the decision or withholding its consent.

The veto, then, in contrast to the strict rule of unanimity, has the effect of not only freeing the dissenting state from any legal obligation under the decision, but of stopping the lawgiving or law-enforcing process altogether. While the rule of unanimity is a logical consequence of sovereignty, this cannot be said of the veto. The rule of unanimity declares: Without my consent your decision does not bind me. The veto declares: Without my consent there is no decision at all. The veto, in other words, confronts the states participating in the deliberations with the alternative of either agreeing upon a collective decision adhered to by all, or of having no decision at all. As concerns this dual function, at once destructive and creative, the veto is more than a mere manifestation of sovereignty. Of this more is to be said later.<sup>1</sup>

### 3. WHAT SOVEREIGNTY IS NOT

After having learned what sovereignty is, we may now turn to the discussion of what sovereignty is not but is often believed to be.

1. Sovereignty is not freedom from legal restraint. The quantity of legal obligations by which the state limits its freedom of action does not as such affect its sovereignty. The often-heard argument that a certain treaty would impose upon a country obligations so onerous as to destroy its sovereignty is, therefore, meaningless. It is not the quantity of legal restraints which affects sovereignty, but their quality. A state can take upon itself any quantity of legal restraints and still remain sovereign, provided those legal restraints do not affect its quality as the supreme lawgiving and law-enforcing authority. But one single legal stipulation affecting that authority is in itself sufficient to destroy the sovereignty of the state. Hence, whatever the merits and demerits of the United States' joining the League of Nations and the Permanent Court of International Justice may have been, since these steps could not have affected the supreme authority of the United States within its territory, they had nothing to do with the sovereignty of the United States.

2. Sovereignty is not freedom from regulation by international law of all those matters which are traditionally left to the discretion of the individual states or, as Article 15, paragraph 8, of the Covenant of the League of Na-

---

<sup>1</sup> See below, Chapters XXV, XXVIII.

## *Politics among Nations*

tions<sup>2</sup> and Article 2, paragraph 7, of the Charter of the United Nations put it, are within the domestic jurisdiction of the individual states. The relation between the matters which international law regulates and those with which it does not concern itself is fluid. It depends upon the policies pursued by individual states and upon the development of international law. It is, therefore, misleading to assert, for instance, that the international regulation of the immigration policies of individual states would be incompatible with their sovereignty. This would hold true only for international regulations to which the countries concerned had not consented beforehand. The conclusion of international treaties concerning matters of immigration would not affect the sovereignty of the contracting states.

3. Sovereignty is not equality of rights and obligations under international law. Great inequalities in these respects can go hand in hand with sovereignty. Peace treaties frequently impose heavy disabilities upon the vanquished with regard to size and quality of the military establishment, armaments, fortifications, reparations, economic policies, and the conduct of foreign affairs in general. The defeated nation is not thereby deprived of its sovereignty. Germany, Austria, Hungary, and Bulgaria remained sovereign states despite the one-sided legal obligations with which the peace treaties of 1919 burdened them. The same peace treaties singled out certain of the victorious states, such as Czechoslovakia, Poland, and Rumania, for special obligations concerning the treatment of certain racial and religious minorities among their own subjects. Rumania, together with Bulgaria, Montenegro, and Serbia, was subjected to such international obligations by the very treaty which in 1878 recognized it as a sovereign nation. Frequently nations, having to comply with legal obligations of which other nations were free, have invoked the principles of sovereignty and equality in order to justify their demands for removal of those legal burdens. In such cases, the issue has always been one of revision of treaties, but not at all of sovereignty.

4. Sovereignty is not actual independence in political, military, economic, or technological matters. The actual interdependence of states in those matters and the actual political, military, and economic dependence of certain states upon others may make it difficult or impossible for certain states to pursue independent domestic and foreign policies, but it does not affect their supreme legal authority within their own territories, that is, their sovereignty. They may be unable, because of prevailing actual conditions, to enact and enforce the kinds of laws which they would wish and which more powerful states are able to enact and enforce. But the legal authority, within the limits of their obligations under international law, to enact and enforce the laws they please is not thereby abrogated. The actual inequality of states and their dependence upon each other has no relevance for the legal status called sovereignty. Panama is as sovereign a state as the United States, although in the choice of its policies and laws it is much more limited than the United States.

---

<sup>2</sup> For the text, see above, p. 233 n.

#### 4. HOW SOVEREIGNTY IS LOST

Under what conditions, then, does a state lose its sovereignty? What rules of international law and what kinds of international institutions created by them are actually incompatible with sovereignty? Where is the line to be drawn between legal and actual inequalities which leave sovereignty intact and that impairment of a state's authority which destroys its independence?

In theoretical terms, the answer to these questions presents no difficulty. Since sovereignty is the supreme legal authority of the state to give and enforce the law within a certain territory and, in consequence, independence from the authority of any other state and equality with it under international law, the state loses its sovereignty when it is placed under the authority of another state, so that it is the latter which exercises supreme authority to give and enforce the laws within the former's territory. Sovereignty can thus be lost in two different ways.

A state may take upon itself legal obligations which give another state final authority over its lawgiving and law-enforcing activities. State A will lose its sovereignty by conceding to State B the right to veto any piece of legislation enacted by its own constitutional authorities or any act of law enforcement to be performed by its own executive agencies. In this case, the government of A remains the only lawgiving and law-enforcing authority actually functioning within the territory of A, but it is no longer supreme, since it is, in turn, subject to the control of the government of B. Through the exercise of that control, the government of B becomes the supreme authority and, hence, sovereign within the territory of A.

The other way in which sovereignty can be lost consists in the loss of what we have called the "impenetrability" of a state's territory. Here the government of A is superseded as the lawgiving and law-enforcing authority by the government of B which, through its own agents, performs the lawgiving and law-enforcing functions within the territory of A. The government of A, having lost authority altogether within the territory of A, survives in name and in appearances only, while the actual functions of government are performed by the agents of B.

Great difficulties, however, beset the application of these abstract standards to actual situations and concrete issues. At the root of the perplexities which attend the problem of the loss of sovereignty there is the divorce, in contemporary legal and political theory, of the concept of sovereignty from the political reality to which the concept of sovereignty is supposed to give legal expression.

Today, no less than when it was first developed in the sixteenth century, sovereignty points to a political fact. That fact is the existence of a person or a group of persons who, within the limits of a given territory, are more powerful than any competing person or group of persons and whose power, institutionalized as it must be in order to last, manifests itself as the supreme authority to enact and enforce legal rules within that territory. Thus the absolute monarch of the sixteenth and the following centuries was the su-

## *Politics among Nations*

preme authority, that is, he was sovereign, within his territory not as a matter of theoretical speculation or legal interpretation, but as a political fact. He was more powerful than pope and emperor, on the one hand, and the feudal barons, on the other, and, therefore, he was able to give and enforce laws without interference from either.

Similarly, the federal government is today sovereign within the territory of the United States; for there is no supranational authority which could challenge its power nor are there sectional or functional authorities within its territory which could think of doing so. This sovereignty, no less than the sovereignty of the French monarchy in the sixteenth century, is the result of the actual distribution of power in the state. It is, therefore, primarily the result of the Union's victory over the Confederacy in the Civil War. If the supreme authority of the federal government within the territory of the United States were to be whittled down by political or economic organizations strong enough to legislate for themselves and enforce their laws without effective control on the part of the federal government, a situation might arise similar to the one which confronted the emperor when at the end of the Middle Ages the territorial states substituted their own supreme authority for his. The United States would then split into a number of territorial or functional units which would be actually sovereign although the federal government might still for a time, just like the emperor, retain the legal attributes and the prestige of the sovereign power.

Four conclusions follow from the preceding discussion:

1. The location of sovereignty depends upon a dual test: (a) in what respects is the government of the state legally controlled by another government? and (b) which government actually performs governmental functions within the territory of the state?
2. The location of sovereignty is a matter of political judgment as well as of legal interpretation.<sup>3</sup>
3. The location of sovereignty may be in temporary suspense if the actual distribution of power within a territory remains unsettled.
4. Sovereignty over the same territory cannot reside simultaneously in two different authorities; that is, sovereignty is indivisible.

The analysis, in the light of these four conclusions, of a number of historical situations will provide a test for the usefulness of the concept of sovereignty developed in these pages in view of the all-important question as to which international obligations are compatible with sovereignty, and which are not.

1. Before the declaration of Indian independence in 1947 the relations between the Indian states and Great Britain were regulated by treaties. While guaranteeing the internal independence of these states, these treaties gave to Great Britain the right to protect them against aggression, the administration of their foreign affairs, and the general supervision of their internal administration. Although most of these governments had virtually complete control within their territories, they were, in turn, completely controlled by the Brit-

<sup>3</sup> Cf. Mr. Justice Holmes in *American Banana Co. vs. United Fruit Co.*, 213 U. S. 347 at 358 (1909): ". . . sovereignty is pure fact"; and in *The Western Maid*, 257 U. S. 419 at 432 (1921): "Sovereignty is a question of power, and no human power is unlimited."

ish government and, therefore, they were not sovereign. Both British and Indian courts have so decided.

2. It is instructive to contrast the foregoing situation with the so-called Platt Amendment, incorporated into the Treaty of Havana of 1901 between the United States and Cuba. The Amendment obligated Cuba not to enter into any international treaty impairing its independence or giving control over any portion of Cuban territory to any foreign power. Cuba was not to contract any public debts which could not be taken care of by its ordinary revenue. It was to provide for the sanitation of its cities in order to prevent the recurrence of epidemic and infectious diseases. And it was to sell or lease to the United States lands necessary for coaling or naval stations at points to be agreed upon with the President of the United States. These provisions restricted to an unusual degree the discretion of the Cuban government in foreign and domestic affairs and even obligated it to surrender its sovereignty over certain parts of Cuban territory. But, since they did not substitute the American for the Cuban government as the supreme lawgiving and law-enforcing authority within Cuban territory, these provisions did not affect the sovereignty of Cuba.

The situation is not so simple with regard to Article 3 of the Treaty of Havana which reads that ". . . the government of Cuba consents that the United States may exercise the right to intervene for the preservation of Cuban independence, the maintenance of a government adequate for the protection of life, property, and individual liberty." This provision gave the government of the United States the right to take over the government of Cuba and thus to destroy Cuban sovereignty under conditions so general as to leave the discretion of the United States in this respect virtually without limits. Had the government of the United States chosen to avail itself of this right to the fullest extent and to establish its control permanently over the government of Cuba, Cuba would have been no more a sovereign state than were the Indian states under British domination. Had the United States, on the other hand, never made use of the right stipulated in Article 3 of the Treaty of Havana, the sovereignty of Cuba would have remained intact; for then the government of Cuba, in its actual lawgiving and law-enforcing operations, would have been permanently free from foreign control. It would have remained the supreme authority within the national territory, regardless of the potential legal possibility of foreign control.

Actually, however, the United States availed itself of the right under Article 3 of the Treaty of Havana and subjected the Cuban territory to military occupation from 1906 to 1909. During that period, supreme authority within the Cuban territory was exercised by the armed forces of the United States and not by the government of Cuba. The government of Cuba, therefore, was no longer sovereign. Whether or not the government of Cuba regained sovereignty immediately after the evacuation of the American troops in 1909 is a question the answer to which depended in 1909 upon the evaluation of the future political intentions of the United States with respect to Cuba. It could be answered unqualifiedly in the affirmative only if the government of the United States had made it clear in 1909 that it would abstain in the future from making use of Article 3 of the Treaty of Havana. In the absence of such

## *Politics among Nations*

a clarification of future intentions, the answer to our question could in 1909 be derived only from hunches as to what the policy of the United States was likely to be. Was the United States likely to pursue a policy of abstention in spite of its contractual right to intervene in Cuban affairs? Then sovereignty would have reverted to the government of Cuba. Was the United States, on the other hand, to be expected to resort to Article 3 of the Treaty of Havana in order to decide at least all important differences between itself and Cuba in its favor? Then supreme authority within the territory of Cuba would have passed to the United States. The question was answered definitely only in the Treaty of May 31, 1934, which abrogated Article 3 of the Treaty of Havana and re-established without equivocation the sovereignty of the government of Cuba.

This is not the place to go into a detailed analysis of the situation as it existed between 1909 and 1934, in order to determine where sovereignty over Cuba was vested during that period. What is important in view of our discussion is to realize that the exercise of sovereignty is a political fact, defined and circumscribed in legal terms. Therefore, its determination may well depend upon gradual shifts in the exercise of political power from one government to another. It is to be detected through the appraisal of the political situation rather than through the interpretation of legal texts.<sup>4</sup>

3. We have pointed out above that the quantity of legal obligations by which a state binds itself in its relations with other states cannot, as such, affect its sovereignty. This statement requires elaboration in the light of the foregoing discussion. While it is true that a state cannot lose its sovereignty by limiting its freedom of action through the conclusion of a great number of international treaties, it will have lost its sovereignty if its freedom of action no longer extends to those fundamental lawgiving and law-enforcing functions without which no government can under contemporary conditions maintain its authority within the national territory. In other words, it is not the quantity of legal commitments, but their influence upon the quality of the government's political control which determines the issue of sovereignty. Three historic examples will make that issue clear: the position of the individual states under the United States proposal for the international control of atomic energy; the relation between the permanent members of the Security Council and the other member states of the United Nations; and, finally, the position of the individual states with regard to deviations from the principle of unanimity in international organizations other than the Security Council.

### *a) The United States Proposal for International Control of Atomic Energy*

The United States proposal for the international control of atomic energy can, for the purposes of our discussion, be divided into management and control, on the one hand, and enforcement actions, on the other. According to the proposal, an international agency called the Atomic Development Author-

<sup>4</sup> The value of the criterion developed in the text might well be tested by the analysis of the status of countries, such as the British Dominions, Egypt, and the Philippines, in different periods of history.



ity would be set up. It would have as its purpose the prevention of the manufacture or use of atomic weapons for mass destruction and the promotion of the use of atomic energy for peaceful ends. To achieve its purpose, the Atomic Development Authority would have "managerial control or ownership of all atomic energy activities potentially dangerous to world security" and the right "to control, inspect, and license all other atomic energy activities," that is, those which are directed toward peaceful uses. Specifically, the American proposal gives the Authority the following powers:

(a) To obtain and maintain complete and exclusive control or ownership of all uranium, thorium, and other material which may be a source of atomic energy wherever present in potentially dangerous quantities whether in raw material, by-product, processed, or other form;

(b) To conduct continuous investigations and surveys of sources of atomic energy throughout the world, in aid of the proper exercise of the foregoing and the Authority's other functions and powers;

(c) To acquire, construct, own, and exclusively operate all facilities for the production of U-235, plutonium, and such other fissionable materials as may be specified by the Authority and to maintain supplies of fissionable materials adequate to fulfil the purposes of the Authority;

(d) To define and determine, in the manner set forth in the charter, any other facilities or activities in the field of atomic energy which would be dangerous unless controlled by the Authority, and to supervise and have complete managerial control of all such activities and facilities;

(e) To have unhindered access to, and power to control, license, and inspect all other facilities which possess, utilize or produce materials which are a source of atomic energy, and all other activities which utilize or produce, or are capable of utilizing or producing, atomic energy;

(f) To have the exclusive right of research in the field of atomic explosives;

(g) To foster and promote the non-dangerous use and wide distribution of atomic energy for beneficial purposes under licenses or other suitable arrangements established by the Authority; and

(h) Subject to the provisions of the treaty and charter, to have power to take other necessary action and to issue rules and regulations.<sup>5</sup>

The outstanding characteristic of these provisions is the abrogation of the principle of "impenetrability" of the national territory, in so far as the production and the use of atomic energy in all its aspects is concerned. For the Atomic Development Authority national boundaries cease to exist. Its agents can go wherever they please, inspecting, controlling, doing research, constructing, producing, issuing rules and regulations. Theirs is indeed "One World" in which they exercise supreme lawgiving authority, subject only to the terms of the charter, that is, the constitution under which the Atomic Development Authority, like any other governmental agency, would operate. Does the Authority thereby become a world government, exercising sovereignty within the territory of the signatories of the charter and thus making the latter's sovereignty obsolete? The answer to that question depends upon the actual distribution of power between the Authority and the national governments within whose territories it would perform its functions.

<sup>5</sup> United Nations Documents, Atomic Energy Commission, Official Records, No. 1, June 14, 1946.

## *Politics among Nations*

If one assumes, as some do, that atomic energy will soon become the main source of power in our civilization and that investigation and control, in order to be effective, could not be limited to the known sources of raw materials and energy, but would have to have the whole industrial establishment of all the signatories as its potential object, it could hardly be denied that, as a matter of political fact, the power of the Authority would be paramount within the territory of its operation. Then the national governments, however great their autonomy might be in all other fields but atomic energy, would have lost their sovereignty. For the Atomic Development Authority, while limited in its functions to only one specific field of governmental activities, would, because of the overriding importance of that field, obtain a key position in the industry, economy, science, social activities, and political life of the nations concerned. They would be under the legal obligation, according to the suggested charter, to submit virtually all their socially important national activities to the orders and measures of the Authority. By virtue of its legal powers according to the charter, the Atomic Development Authority would have supreme authority within the national territories and would be sovereign.

If one assumes, however, as most observers seem inclined to do, that, at least for the foreseeable future, the managerial and controlling functions of the Authority would be strictly limited both in actual operations and in their impact upon the national life of the signatories, the national governments would retain a decisive advantage in the distribution of power. Hence, they would not lose their sovereignty on account of the managerial and controlling activities of the Authority. The latter's powers would then not differ in kind from the powers of other international organizations, such as the International Danube Commission, which exercise certain powers within national territories, but whose activities, due to the strictly limited character of those powers, do not affect the sovereignty of the governments concerned.

The situation relative to the enforcement of the decisions of the Authority is not essentially different from what we have found it to be in the field of management and control. The United States proposal makes the Security Council of the United Nations the primary enforcement agency for the decisions of the Authority.<sup>9</sup> It obviously envisages types of enforcement measures especially adapted to the illicit production and use of atomic energy and as such not specifically considered by the Charter of the United Nations. Yet the Security Council operating within the meaning of the United States proposal is not identical with the Security Council as envisaged by Article 27, paragraph 3, of the Charter of the United Nations. For the United States has insisted that the veto of the permanent members of the Security Council should not operate against enforcement measures to be taken against the violation of decisions of the Authority. It has insisted that an affirmative vote of any seven members of the Security Council should be sufficient to put the enforcement machinery of the United Nations into motion. In other words, if any seven out of eleven members of the Security Council decide that certain enforcement measures are to be taken by certain or all member states against

<sup>9</sup> *Ibid.*, under (g).

another state, all member states are under the legal obligation to execute the decision of the Security Council. The United States proposal constitutes the Security Council as a supranational centralized agency for the purpose of enforcing the decisions of the Atomic Development Authority.

The Security Council would have no means of enforcement of its own. It would have to rely upon measures to be taken by the Authority and upon the member states' faithfully fulfilling their legal obligations under Articles 41 ff. of the Charter of the United Nations. Granted this latter condition, no organic obstacle would stand in the way of effective enforcement action. For with the consensus of the permanent members being no longer a prerequisite for enforcement action — a prerequisite which, as we have seen, is difficult of attainment under all circumstances and which is at present altogether impossible of realization — the main stumbling block to such action would have disappeared. The Security Council would then be in practice as well as in law the supreme authority, so far as the enforcement of the decisions of the Atomic Development Authority is concerned.

Whether or not this would make the Security Council the enforcement agency of a world government, superseding the national sovereignties, is again a question which must be answered in the light of the distribution of power between the Security Council and the national governments. Our previous considerations relative to management and control apply here. If atomic energy should become of paramount and all-permeating importance, sovereignty would indeed pass from the national governments to a world government, composed of the Atomic Development Authority and the Security Council. If, on the other hand, the over-all impact of atomic energy should remain slim and its importance rather strictly limited, the Security Council would fulfill the functions of a specialized international agency which by common agreement has the authority to request individual states to perform certain limited enforcement actions.

*b) Majority Vote in International Organizations*

It has been said frequently in view of Article 27, paragraph 3, of the Charter of the United Nations that, while the permanent members of the Security Council have retained their sovereignty, the other members of the United Nations have lost theirs. The text of Article 27, paragraph 3, lends itself to such an interpretation; for, in so far as the relations between the permanent and the nonpermanent members of the Security Council and between the members of the Security Council and the other members of the United Nations are concerned, the majority principle replaces the principle of unanimity. In other words, "an affirmative vote of seven members including the concurring votes of the permanent members" of the Security Council binds all members of the Security Council as well as all members of the United Nations. If such a majority vote could put the instrumentalities of law enforcement of the individual states at the disposal of the United Nations to be applied against any recalcitrant members, then the Security Council would indeed have supreme authority over the member states which are not permanent members of the Security Council. It, instead of the governments of those

## *Politics among Nations*

states, would be sovereign. While this result is legally possible by virtue of Article 27, paragraph 3, in conjunction with Articles 39, 41, 42 of the Charter,<sup>7</sup> its actual realization depends upon three political conditions, none of which exists at present and which are not likely to exist simultaneously in the foreseeable future.

First, there must be unanimity as the legal manifestation of political harmony among the five permanent members of the Security Council in order that the Security Council exist at all as an operating law-enforcing agency. Second, the military forces which the member states agree, according to Articles 43 ff., to put at the disposal of the Security Council must be substantial enough to give the forces of the United Nations, available at any particular point, unquestioned superiority over the forces of lawlessness. The military forces of the world, in other words, must be so distributed as to make the forces of the United Nations stronger than the national forces of any single state or any likely combination of states. Third, each member state must execute its obligations under the Charter, and especially under the military agreements, in good faith. It must sacrifice its national interests to the common good of the United Nations as defined by the Security Council. If these three conditions were realized today or were capable of realization in the foreseeable future, one could indeed say that the Charter of the United Nations had eliminated, or was on its way to eliminate, the national sovereignty of those member states which are not permanent members of the Security Council. Yet only a legalistic conception of sovereignty could disregard these conditions of a political nature and derive its conclusions from the legal texts alone.

Owing to a similarly legalistic trend of thought, the contention is frequently advanced that unequal representation and majority decision in international agencies are incompatible with the sovereignty of the states concerned. It was this argument which defeated all proposals for the establishment of a genuine international court at the two Hague Peace Conferences. It was widely used against the United States' joining the League of Nations and the Permanent Court of International Justice. Here again so sweeping an assertion needs to be qualified by political distinctions. In the light of these distinctions unequal representation and majority rule may or may not be compatible with sovereignty. The answer would depend on whether or not this deviation from the rule of unanimity transfers supreme authority from the national governments to an international agency.

Aside from the International Court of Justice where, as we have seen, the principle of unanimity is impossible of realization, there exists a considerable number of international agencies, performing legislative, administrative, and executive functions, which deviate from the principle of unanimity. A number of international administrative organizations—such as the Universal Postal Union, the International Telegraphic Union, the Radiotelegraphic Union, and the International Union for Weights and Measures—accord representation with voting power to the dependencies of its member states, thus giving the latter more than one vote. Others, such as the Telecommunication Union, for obviously political reasons allow certain states more than one vote,

---

<sup>7</sup> For the text of these provisions see below, — Appendix.

in addition to permitting dependencies to vote. Thus Article 21 of the Internal Regulations of the Madrid Conference of 1932, which was accepted by the Cairo Conference of 1938 for all future International Telecommunication Conferences, gives three votes to France and Great Britain (including India), two votes to Belgium, Germany, Italy, Japan, the Netherlands, Portugal, the Soviet Union, Spain, and the United States, and one vote to all other states.

Many international organizations determine the voting strength of their members on the basis of their financial contribution. On that basis the convention establishing the International Institute of Agriculture gave Great Britain twenty-two votes, the United States twenty-one, France nineteen, and so on. The international agreements creating the International Monetary Fund and the International Bank for Reconstruction and Development correlate voting strength to financial contribution. As a result, the United States has in both organizations more than a hundred times as many votes as the state with the lowest voting strength.

The most frequent abrogation of the rule of unanimity is, however, the outright provision for majority rule. It is found, for instance, in the Universal Postal Union, the International Danube Commission, the Food and Agricultural Organization, the International Civil Aviation Organization, the Economic and Social Council and the Trusteeship Council of the United Nations. According to Article 18 of the Charter of the United Nations, each member of the General Assembly shall have one vote, and decisions shall be made by a majority of the members present and voting. Decisions on what Article 18, paragraph 2, calls "important questions" require a two-thirds majority.

The Security Council, in its composition as well as in its voting procedure, marks a departure from the principle of equal voting strength. According to Article 27, each member of the Security Council shall have one vote and its decisions on procedural matters shall be made by an affirmative vote of seven out of the eleven members. But their permanent representation, according to Article 23, gives China, France, Great Britain, the Soviet Union, and the United States an automatic preponderance in the decisions of the Security Council over the six nonpermanent members to be elected periodically by the General Assembly. This preponderance is considerably enhanced by the right of the permanent members to veto the nonprocedural decisions of the Security Council according to Article 27, paragraph 3.

Evaluation of the bearing which these departures from the principle of equality of voting strength have upon the sovereignty of the states concerned must again be guided by the criterion of where, in consequence of these departures, the supreme lawgiving and law-enforcing authority within the territories of these states is located. What is decisive in this respect is again not how and in how many different matters and organizations a state is outvoted by others, but in what kinds of matters. Here, too, the test is qualitative and not quantitative. The fact that a state is under the legal obligation to execute the majority decision of an international organization with regard to the postage on letters in international traffic does not affect its quality as the supreme lawgiving authority within the national territory. The state has con-

## *Politics among Nations*

sented to forego freedom of action where, by virtue of its sovereignty, freedom of action would exist in the absence of such consent. But it has not renounced its sovereignty.

The state would have renounced its sovereignty if it had consented to submit to the majority vote of an operating international agency such matters as amendments to the constitution, declaration of war and conclusion of peace, size, composition, and activities of the armed forces, composition of the government, and financial policies. Then, by virtue of the international agreement establishing majority rule, the decisive political power would have shifted from the national government to the international agency. It would no longer be the national government, but the international agency, which would hold supreme power and, hence, exercise supreme lawgiving and law-enforcing authority within the national territory.

It is obvious from what has been said already that nowhere on the contemporary international scene do deviations from the rule of unanimity affect the sovereignty of the individual state. International adjudication is surrounded by elaborate safeguards which prevent matters of political importance from being decided by the majority vote of an international court. The majority vote in international administrative organizations is able to dispose of technical matters only, matters which have no significance for the distribution of power among national governments or between national governments and international agencies. Concerning the majority vote in the General Assembly of the United Nations, Professor Lauterpacht has wisely remarked: "In assessing the bearing, upon the sovereignty of the members of the Assembly, of the departure from the traditional principles of unanimity, the fact must be borne in mind that the Assembly has no power to adopt decisions binding upon the United Nations."<sup>8</sup> The strict majority decision of the Security Council, according to Article 27, paragraph 2, of the Charter, deals only with procedural matters which can have no bearing upon the supreme authority of the member states within their territories. The potentialities for superseding the national sovereignties with the sovereignty of the Security Council, which are legally implicit in Article 27, paragraph 3, are, as has been shown, incapable of realization at present or in the foreseeable future.

### 5. IS SOVEREIGNTY DIVISIBLE?

Our discussion has brought us to the last and perhaps the most important of the misunderstandings which have obscured the problem of sovereignty in the modern world — the belief that sovereignty is divisible. Elucidation of this misunderstanding may aid us in assessing the role of sovereignty, and of international law in general, in contemporary international politics. We have heard it said time and again that we must "surrender part of our sovereignty" to an international organization for the sake of world peace, that we must "share" our sovereignty with the Atomic Development Authority, that the latter would have a certain "limited sovereignty" while we would keep the substance of it,

---

<sup>8</sup> Oppenheim-Lauterpacht, *International Law*, I, 396.

or vice versa, that there are "quasi-sovereign" and "half-sovereign" states. We shall endeavor to show that the conception of a divisible sovereignty is contrary to logic and politically unfeasible, that it is, however, a significant symptom of the discrepancy between the actual and pretended relations which exist between international law and international politics in the modern state system.

If sovereignty means supreme authority, it stands to reason that not two or more entities — persons, groups of persons, or agencies — can be sovereign within the same time and space. He who is supreme is by logical necessity superior of everybody else; he can have no superiors above him nor equals besides him. If the President of the United States is the Commander-in-Chief of the armed forces, it is logically absurd to assert that somebody else, let us say, the Secretary of Defense, shares with him supreme authority over the armed forces. The Constitution might have divided this supreme authority between the two officials along functional lines — just as, according to medieval doctrine, supreme authority was divided between emperor and pope — so that, let us assume, the President would have supreme authority over the organization and supply of the armed forces and the Secretary of Defense over their military operations. If this were the actual division of authority and the actual distribution of functions, nobody would be Commander-in-Chief because nobody would have supreme over-all authority over the armed forces. The office of Commander-in-Chief could not logically exist. Either the President commands the armed forces with ultimate authority, or somebody else does, or nobody does. These alternatives are logically conceivable, although not all of them, as we shall see, are politically feasible. But that the President as well as somebody else commands the armed forces with ultimate authority at the same time is both logically untenable and beyond the reach of political achievement.

A consideration of the actual political functions fulfilled by the sovereign authority within the state will make it clear that sovereignty cannot be divided in political actuality. Sovereignty signifies supreme lawgiving and law-enforcing authority. That is to say, that authority within the state is sovereign which, in case of dissension among the different lawmaking factors, has the responsibility for making the final binding decision and which, in a crisis of law enforcement, such as revolution or civil war, has the ultimate responsibility for enforcing the laws of the land. That responsibility must rest somewhere — or nowhere. But it cannot be here and there at the same time. As Mr. Justice Sutherland said in *United States vs. Curtiss Wright Export Corporation*: "A political sovereignty cannot endure without a supreme will somewhere. Sovereignty is nowhere held in suspense."<sup>9</sup> If it rests nowhere — and there are constitutions, such as the Constitution of the Third French Republic, which seem to assign no place to it — in times of constitutional crisis one of the constitutional authorities will usurp that responsibility, or else revolution will invest somebody, a Napoleon or a Council of People's Commissars, with supreme authority to make an end to chaos and to establish peace and order. If the location of sovereignty seems to be held in abeyance because the constitution lends itself to different interpretations on that point, a struggle, politi-

<sup>9</sup> 299 U. S. 304 at 316, 317 (1936).

## *Politics among Nations*

cal or military, between the pretenders to supreme authority will decide the question one way or the other. The struggle between the federal government and the states, issuing in a civil war which decided the question in favor of the federal government, is a classic example of this situation.

The simple truth that a divided sovereignty is logically absurd and politically unfeasible was never doubted by virtually all members of the Constitutional Convention of 1787.<sup>10</sup> Those who believed that sovereignty ought to be vested in the states as well as those who wanted it to be located in a central government were convinced that it must reside either here or there, but could not be divided between both. "I hold it for a fundamental point," wrote Madison to Randolph on April 8, 1787, "that an individual independence of the states is utterly irreconcilable with the idea of an aggregate sovereignty."<sup>11</sup> "We have been told," declared James Wilson on the floor of the Convention, "that, each state being sovereign, all are equal. So each man is actually a sovereign over himself, and all men are therefore naturally equal. Can he retain his equality when he becomes a member of a civil government? He cannot. As little can a sovereign state, when it becomes a member of a federal government. If New Jersey will not part with her sovereignty, it is vain to talk of government."<sup>12</sup> In the words of Hamilton: "Two sovereignties cannot co-exist within the same limits."<sup>13</sup>

It was Madison, however, who put his finger on the qualitative element of political authority, in contrast to the "more or less" of treaty obligations, as the distinctive characteristic of the sovereignty of a government and, as such, incompatible with the sovereignty of those subordinate to it. Madison declared on June 28, 1787, on the floor of the Convention:

This fallacy of the reasoning drawn from the equality of sovereign states, in the formation of compacts, lay in confounding mere treaties, in which were specified certain duties to which the parties were to be bound and certain rules by which their subjects were to be reciprocally governed in their intercourse, with a compact by which an authority was created paramount to the parties, and making laws for the government of them. If France, England, and Spain, were to enter into a treaty for the regulation of commerce, &c., with the Prince of Monaco, and four or five other of the smallest sovereigns of Europe, they would not hesitate to treat as equals, and to make the regulations perfectly reciprocal. Would the case be the same if a council were to be formed of deputies from each, with authority and discretion to raise money, levy troops, determine the value of coin, &c.?<sup>14</sup>

Democratic constitutions, especially those consisting of a system of checks and balances, have purposely obscured the problem of sovereignty and glossed over the need for a definite location of the sovereign power. For while it is the main concern of these constitutions to create devices for the limitation and

<sup>10</sup> The exception is Dr. Johnson. See *Debates on the Adoption of the Federal Constitution*, Vol. V of Ellior's *Debates* (Washington, 1845), p. 221.

<sup>11</sup> *Ibid.*, p. 107.

<sup>12</sup> *Ibid.*, p. 177.

<sup>13</sup> *Ibid.*, p. 202; cf. also p. 199. The same point is made by Dr. Johnson who said, in contrast to his remarks referred to in Note 10, that sovereignty "can be but one in the same community" (*Ibid.*, p. 448).

<sup>14</sup> *Ibid.*, p. 250; cf. also Patterson, *ibid.*, p. 194.



control of personal power, the clearest case of a sovereignty, definitely located, is the unfettered authority of Hobbes' *Leviathan*, the source not only of law, but of ethics and mores as well. Thus the popular constitutional doctrines, rightly fearful of the unlimited power of absolute monarchy and of the risks of personal government, confounded the subjection of the sovereign authority to legal controls and political restraints with its elimination. In their endeavor to make democracy "a government of laws and not of men" they forgot that in any state, democratic or otherwise, there must be a man or a group of men ultimately responsible for the exercise of political authority. Since in a democracy that responsibility lies dormant in normal times, barely visible through the network of constitutional arrangements and legal rules, it is widely believed that it does not exist, and that the supreme lawgiving and law-enforcing authority, which was formerly the responsibility of one man, the monarch, is now distributed among the different co-ordinate agencies of the government and that, in consequence, no one of them is supreme. Or else that authority is supposed to be vested in the people as a whole, who, of course, as such, cannot act. Yet in times of crisis and war that ultimate responsibility asserts itself, as it did under the presidencies of Lincoln, Wilson, and the two Roosevelts and leaves to constitutional theories the arduous task of arguing it away after the event.

In federal states, monarchical or democratic, ideological satisfaction must be given to the individual states which, once having been sovereign, are so no longer, yet are loath to admit it. To that end political practice develops a whole system of constitutional flatteries which bestows upon the officials and symbols of the individual states the honors due the officials and symbols of the sovereign states, and which makes use of concepts and constitutional devices which have meaning only with reference to sovereign states.<sup>15</sup> Since it is constitutionally and politically impossible to deny that the federal government is sovereign and since it is psychologically impossible to admit that the individual states are no longer sovereign, constitutional theory simply divides sovereignty between the federal government and the states, thus trying to reconcile political realities with political preferences. So it came about that Hamilton and Madison, who had emphatically proclaimed the indivisibility of sovereignty on the floor of the Convention of 1787, were just as emphatic in their insistence upon the divisibility of sovereignty when a year later in *The Federalist* they endeavored to persuade the states that they could keep their sovereignty even though they endowed the federal government with the sovereign powers provided for in the new constitution.<sup>16</sup>

<sup>15</sup> The constitutional practices of the United States, of the Soviet Union, and of Germany under the Constitution of 1871 illustrate this point.

<sup>16</sup> Cf. C. E. Merriam, *History of the Theory of Sovereignty since Rousseau* (New York: The Columbia University Press, 1900), p. 161: "The constitution reflected, therefore, the political facts and the political theory of the time in its peculiar division of powers between local and central governments, and in its failure to define clearly and explicitly the ultimate source of sovereign power."

For the general phenomenon of the discrepancy between theories of sovereignty and the political reality of sovereignty, see also Ernest Barker, *Essays on Government* (Oxford: Oxford University Press, 1945), pp. 88, 89: "It may be said, in a paradox, that France, professing a doctrine of national sovereignty, really practises a system of parliamentary sovereignty, while Great Britain, professing a doctrine of the sovereignty of Parliament, really practises a system of

## *Politics among Nations*

Because of a similar need for building an ideological bridge between political realities and political preferences, the doctrine of divided sovereignty has gained wide acceptance in the field of international relations. On the one hand, the national state is to a higher degree than ever before the predominant source of the individual's moral and legal valuations and the ultimate point of reference for his earthly loyalties. Consequently, its power among the other nations and the preservation of its sovereignty are the individual's foremost political concerns in international affairs. On the other hand, it is that very power and sovereignty, clashing under the conditions of modern civilization with the power and sovereignty of other nations, which imperils the existence of that civilization and, with it, of the national states themselves.

Thus, since the end of the Napoleonic Wars, humanitarians and statesmen have with ever increasing frequency and intensity searched for means to avoid the self-destructive wars to which the struggle for power among modern national states gives rise. It has, however, become more and more obvious, especially in recent years, that the main stumbling block which thus far has vitiated all attempts at restraining the struggle for power on the international scene is national sovereignty itself. As long as the supreme lawgiving and law-enforcing authority remains vested in the national governments, war, especially under the moral, political, and technological conditions of our age, may be said to be unavoidable. Thus the political reality of the likelihood of self-destructive war confronts the political preference for the preservation of national sovereignty. While people everywhere are anxious to free themselves from the threat of war, they are also anxious to preserve the sovereignty of their respective nations. Yet if the price of peace were only a slice of sovereignty and not the whole of it, if in order to lessen the likelihood of war it were necessary for the national state only to share sovereignty with an international organization and not to give it up altogether, one might have peace and national sovereignty at the same time.

In a public-opinion poll taken in the spring of 1947, 75 per cent of the people answered in the affirmative the question: "Would you like to see the United States join in a movement to establish an international police force to maintain world peace?" However, only 15 per cent of the total population and 17 per cent of those in favor of an international police force were willing to consent to the United States armed forces being smaller than the international police force. "Only 13 per cent of all the people want the United States to join in an international police force and are also willing to have the police force outnumber the armed forces of this country."<sup>17</sup> In other words, while a considerable majority of the American people favor an international organization capable of preventing war, only a small minority of those favoring such

---

the virtual sovereignty of cabinet. Neither country does what it professes, but either country does something different from the other; and while Great Britain has a dominant cabinet tending to control the Parliament, France has a dominant Parliament installing, evicting, and controlling a series of cabinets."

<sup>17</sup> *UNESCO and Public Opinion Today* (Chicago: National Opinion Research Center, 1947), Report No. 35, pp. 12 ff. A number of other polls, taken in recent years in this country and in Great Britain, have had similar contradictory results. Cf. particularly *Peace and the Public. A Study by Mass-Observation* (London, New York, Toronto: Longmans, Green and Co., 1947).

## *Sovereignty*

an organization (as well as of the people as a whole) are willing to transfer supreme law-enforcing authority, that is, sovereignty, from the United States to an international organization. The majority want to have it both ways; they want to "divide" sovereignty. It is significant in this respect that while 32 per cent of those favoring an international police force want the American forces to be larger than the international police force, 41 per cent, by far the largest of the groups expressing an opinion on the matter, want them to be of equal size. They want to "divide" sovereignty fairly and equitably by leaving 50 per cent with the United States and giving 50 per cent to an international organization.

Of this contradiction between political reality and political preference, the belief in a divisible sovereignty is the ideological manifestation. The doctrine of the divisibility of sovereignty makes it intellectually feasible to reconcile not only what logic proves to be incompatible—to give up sovereignty while retaining it—but also what experience shows to be irreconcilable under the conditions of modern civilization—national sovereignty and international order. Far from expressing a theoretical truth or from reflecting the actuality of political experience, the advice to give up "a part of national sovereignty" for the sake of the preservation of peace is tantamount to the advice to close one's eyes and dream that one can eat one's cake and have it, too.

*PART SEVEN*

WORLD POLITICS IN THE  
MID-TWENTIETH CENTURY



## CHAPTER XVIII

# *The New Moral Force of Nationalistic Universalism<sup>1</sup>*

We should now be able to answer the question we asked when we pointed to the intellectual and moral tradition of the Western World as the force which through the instrumentality of the balance of power kept the modern state system together from the end of the religious wars to the First World War. What is left of this heritage today? we asked then. What kind of consensus unites the nations of the world in the period following the Second World War? <sup>2</sup>

The answer can only be that the limitations upon the struggle for power on the international scene are weaker today than they have been at any time in the history of the modern state system. The one international society of the seventeenth and eighteenth centuries has been replaced by a number of national societies which provide for their members the highest principle of social integration. In consequence, the international morality which in past centuries kept the aspirations for power of the individual states within certain bounds has, except for certain fragmentary restraints, given way to the ethics of individual nations. This ethics not only does not recognize any moral obligations above and apart from it, but even claims universal recognition from all the world. World public opinion is but an ideological shadow without even that substance of common valuations and reactions which in other times at least the international aristocracy shared. The main bulk of the rules of international law owes its existence to the sovereignty of the individual nations. To surround that sovereignty with legal safeguards is one of their main tasks. Far from restraining the aspirations for power of individual nations, they see to it that the power position of individual nations is not adversely affected by whatever legal obligations they take upon themselves in their relations with other nations. What national morality is in the field of ethics, what national public opinion is in the domain of the mores, sovereignty is for international law. It is the manifestation of the nation as the recipient of the individual's

<sup>1</sup> This chapter reformulates what has been said above, pp. 184 ff., about the problem of nationalism and of nationalistic universalism.

<sup>2</sup> See above, p. 166.

## *Politics among Nations*

ultimate earthly loyalties, as the mightiest social force, as the supreme authority giving and enforcing laws for the individual citizen.

The supranational forces, such as universal religions, humanitarianism, cosmopolitanism, and all the other personal ties, institutions, and organizations, which bind individuals together across national boundaries, are infinitely weaker today than the forces which unite peoples within a particular national boundary and separate them from the rest of humanity. This weakening of the supranational forces, which must be strong in order to impose effective restraints upon the international policies of nations, is but the negative by-product of the great positive force which shapes the political face of our age — nationalism. Nationalism, identified as it is with the international policies of individual nations, cannot restrain these policies; it is itself in need of restraint. Not only has it fatally weakened, if not destroyed, the restraints which have come down to us from previous ages, it has also supplied the aspirations for power of individual nations with a good conscience and a pseudo-religious fervor. It has inspired them with a thirst and a strength for universal dominion of which the nationalism of the nineteenth century knew nothing.

The nationalism of the mid-twentieth century is essentially different from what traditionally goes by that name and what culminated in the national movements and the national state of the nineteenth century. Traditional nationalism sought to free the nation from alien domination and give it a state of its own. This goal was considered to be a rightful one not for one nation only, but for all nations. Once a nation had united its members in one state, national aspirations were satisfied, and there was room for as many nationalisms as there were nations which wanted to establish or preserve a state of their own.

The international conflicts in which nationalism of the nineteenth century was involved were, therefore, essentially of two kinds: the conflicts between a nationality and an alien master — the Balkan nations and Turkey, the Slav nations of the Danube basin and the Austro-Hungarian monarchy, the Poles and Russia — and the conflicts between different nationalities over the delimitation of their respective spheres of dominion, such as the struggle between the Germans, on the one hand, and the Poles and the French, on the other. International conflicts in the nineteenth century grew out of either different interpretations of the national principle or else the refusal to accept it at all. It was hoped as late as three decades ago that, once the aspirations of all nations for national states within which to dwell were fulfilled, a society of satisfied nations would find in the legal and moral principles of national self-determination the means for its own preservation.

To call by the same name what inspired the oppressed and competing nationalities of the nineteenth century and what drives the superpowers of the mid-twentieth century into deadly combat, is to obscure the fundamental change which separates our age from the preceding one. The nationalism of today, which is really a nationalistic universalism, has only one thing in common with the nationalism of the nineteenth century, that is, the nation as the ultimate point of reference for political loyalties and actions. Here, however, the similarity ends. For the nationalism of the nineteenth century the

### *New Moral Force of Nationalistic Universalism*

nation is the ultimate goal of political action, the end point of the political development beyond which there are other nationalisms with similar and equally justifiable goals. For the nationalistic universalism of the mid-twentieth century the nation is but the starting point of a universal mission whose ultimate goal reaches to the confines of the political world. While nationalism wants one nation in one state and nothing else, the nationalistic universalism of our age claims for one nation and one state the right to impose its own valuations and standards of action upon all the other nations.

These rival claims to universal dominion on the part of different nations have dealt the final, fatal blow to that social system of international intercourse within which for almost three centuries nations were living together in constant rivalry, yet under the common roof of shared values and universal standards of action. The collapse of that roof has destroyed the common habitat of the nations of the world, and the most powerful of them each assert the right to build it anew in their own image. Beneath the ruins of that roof lies buried the mechanism which kept the walls of that house of nations standing: the balance of power.



## CHAPTER XIX

### *The New Balance of Power*

The destruction of that intellectual and moral consensus which controlled the struggle for power for almost three centuries deprived the balance of power of the vital energy which made it a living principle of international politics. Concomitant with the destruction of that vital energy, the system of the balance of power has undergone three structural changes which considerably impair its operations.<sup>1</sup>

#### I. INFLEXIBILITY OF THE NEW BALANCE OF POWER

The most obvious of these structural changes which impaired the operation of the balance of power is to be found in the drastic numerical reduction of the players in the game. At the end of the Thirty Years' War, for instance, the German Empire was composed of 900 sovereign states which the Treaty of Westphalia in 1648 reduced to 355. The Napoleonic interventions, of which the most notable is the dictated reforms of the Reichstag of Ratisbone of 1803, eliminated more than 200 of the sovereign German states. When the Germanic Confederation was founded in 1815, only thirty-six sovereign states were left to join it. The unification of Italy in 1859 eliminated seven sovereign states, the unification of Germany in 1871, twenty-four. In 1815, at the end of the Napoleonic Wars, eight nations — Austria, France, Great Britain, Portugal, Russia, Prussia, Spain, and Sweden — had the diplomatic rank of great powers. With Portugal, Spain, and Sweden granted such rank only out of traditional courtesy and soon to lose that undeserved status altogether, the number of actually great powers was really reduced to five. In the sixties, Italy and the United States joined them, followed toward the end of the century by Japan.

At the outbreak of the First World War, there were then again eight great powers, of which for the first time two were located totally outside Europe: Austria, France, Germany, Great Britain, Italy, Japan, Russia, and the United States. The end of the First World War found Austria definitely,

---

<sup>1</sup> See above, pp. 139, 140, 148 ff., for other changes which occurred earlier in the century.

## *The New Balance of Power*

and Germany and Russia temporarily, removed from that list. Two decades later, at the outbreak of the Second World War, one could count seven great powers, Germany and the Soviet Union having again become first-rate powers and the others having retained their status. The end of the Second World War saw this number reduced to three, namely, Great Britain, the Soviet Union, and the United States, while China and France, in view of their past or their potentialities, are treated in negotiations and organizations as though they were great powers. In the aftermath of the Second World War, British power has declined to such an extent as to be distinctly inferior to the power of the United States and of the Soviet Union, the only two great powers left at present.

This reduction in the number of states which are able to play a major role in international politics has an important effect upon the operation of the balance of power. This effect gains added importance from the reduction in the absolute number of states through the consolidations of 1648 and 1803 and the national unifications of the nineteenth century. These reductions were only temporarily offset in 1919 by the creation of new states in Eastern and Central Europe; for these states have in the meantime either disappeared as states, for example, the Baltic states, or, in any case, have ceased to be independent factors on the international scene. This development has deprived the balance of power of much of its flexibility and uncertainty and, in consequence, of its restraining effect upon the nations actively engaged in the struggle for power.

In former times, as we have seen, the balance of power operated in the main by way of coalitions among a number of nations. The principal nations, while differing in power, were still of the same order of magnitude. In the eighteenth century, for instance, Austria, France, Great Britain, Prussia, Russia, and Sweden belonged in the same class, in so far as their relative power was concerned. Fluctuations in their power would affect their respective positions in the hierarchy of powers, but not their position as great powers. Similarly, in the period from 1870 to 1914, the game of power politics was played by eight players of the first rank of which six, those of Europe, kept at the game constantly. Under such circumstances no player could go very far in his aspirations for power without being sure of the support of at least one or the other of his co-players, and nobody could generally be too sure of that support. There was virtually no nation in the eighteenth and nineteenth centuries which was not compelled to retreat from an advanced position and retrace its steps because it did not receive the diplomatic or military support from other nations upon which it had counted. This was especially true of Russia in the nineteenth century. On the other hand, if Germany, in violation of the rules of the game, had not in 1914 given Austria a free hand in its dealings with Serbia, there is little doubt that Austria would not have dared to go as far as it did, and that the First World War might have been avoided.

The greater the number of active players, the greater the number of possible combinations and the greater also the uncertainty as to the combinations which will actually oppose each other and as to the role which the individual players will actually perform in them. Both William II in 1914 and Hitler in

## *Politics among Nations*

1939 refused to believe that Great Britain, and ultimately the United States, too, would join the rank of their enemies, and both discounted the effect of American intervention. It is obvious that these miscalculations as to who would fight against whom meant for Germany the difference between victory and defeat. Whenever coalitions of nations comparable in power confront each other, calculations of this kind will of necessity be close, since the defection of one prospective member or the addition of an unexpected one cannot fail to affect the balance of power considerably, if not decisively. Thus in the eighteenth century, when princes used to change their alignments with the greatest of ease, such calculations were frequently almost indistinguishable from wild guesses. In consequence, the extreme flexibility of the balance of power resulting from the utter unreliability of alliances made it imperative for all players to be cautious in their moves on the chessboard of international politics and, since risks were hard to calculate, to take as small risks as possible. In the First World War it was still of very great importance, bearing upon the ultimate outcome of the conflict, whether Italy would remain neutral or enter the war on the side of the Allies. It was in recognition of that importance that both sides made great efforts, by competing in promises of territorial aggrandizement, to influence Italy's decision. The same situation then prevailed, to a lesser degree, even with respect to so relatively weak a power as Greece.

This aspect of the balance of power has undergone a radical transformation in recent years. In the Second World War, the decisions of such countries as Italy, Spain, or Turkey, or even France, to join or not to join one or the other side were mere episodes, welcomed or feared, to be sure, by the belligerents, but in no way even remotely capable of transforming victory into defeat, or vice versa. The disparity in the power of nations of the first rank, such as the United States, the Soviet Union, Great Britain, Japan, and Germany, on the one hand, and all the remaining nations, on the other, was then already so great that the defection of one, or the addition of another, ally could no longer overturn the balance of power and thus materially affect the ultimate outcome of the struggle. Under the influence of changes in alignments one scale might rise somewhat and the other sink still more under a heavier weight, yet these changes could not reverse the relation of the scales which were determined by the preponderant weights of the first-rate powers. It was only the position of the major countries—the United States, the Soviet Union, and Great Britain, on the one hand, Germany and Japan, on the other—that really mattered. This situation, first noticeable in the Second World War, is now accentuated in the polarity between the United States and the Soviet Union and has become the paramount feature of international politics. The power of the United States and of the Soviet Union in comparison with the power of their actual or prospective allies has become so overwhelming that through their own preponderant weight they determine the balance of power between them. That balance cannot be decisively affected by changes in the alignments of their allies, at least for the foreseeable future.

As a result, the flexibility of the balance of power and, with it, its restraining influence upon the power aspirations of the main protagonists on the international scene have disappeared. Two great powers, each incomparably stronger

## *The New Balance of Power*

than any other power or possible combination of other powers, oppose each other. Neither of them need fear surprises from actual or prospective allies. The disparity of power between major and minor nations is so great that the minor powers have not only lost their ability to tip the scales. They have also lost that freedom of movement which in former times enabled them to play so important and often decisive a role in the balance of power. What was formerly true only of a relatively small number of nations, such as certain Latin-American countries in their relations with the United States and Portugal in its relations of Great Britain, is true now of most, if not all, of them: they are in the orbit of one or the other of the two giants whose political, military, and economic preponderance can hold them there even against their will.

This is the exact opposite of the era of ever shifting alliances and new combinations demanding constant vigilance, circumspection, and caution, of which the eighteenth century is the classic exposition. That era lasted through the nineteenth century and the first three decades of the twentieth. Even during the Second World War, it played an important role at least with regard to the anticipated actions of the major belligerents.

Today neither the United States nor the Soviet Union need look over its shoulder, as they still did during the Second World War, lest the defection of one major ally or the addition of one to the other side might upset the balance of power. Nor are they any longer constrained to accommodate their policies to the wishes of doubtful allies and exacting neutrals. No such fears and considerations need restrain their ambitions and actions; they are, as a pair of nations has rarely been before, masters of their own policies and of their own fates. The line between the two camps is clearly drawn, and the weight of those few which might still straddle the fence is so small as to be virtually negligible, or, as in the case of China and India, a matter of future development rather than a concern of the present. There are no longer neutrals which, as "honest brokers," can mitigate international conflicts and contribute to their peaceful settlement or else, by maneuvering between the two camps and threatening to join the one or the other as occasion might require, erect effective barriers to limitless aspirations for power.

### 2. DISAPPEARANCE OF THE BALANCER<sup>2</sup>

The second change in the structure of the balance of power, which we are witnessing today, is but the inevitable result of the change just discussed. It is the disappearance of the balancer, the "holder" of the balance. Both naval supremacy and virtual immunity from foreign attack for more than three centuries enabled Great Britain to perform this function for the balance of power. Today Great Britain is no longer capable of performing it; for the United States has far surpassed Great Britain in naval strength, and the modern technology of war has deprived navies of uncontested mastery of the seas. Modern instruments of warfare have not only put an end to the invulnerability of the British Isles, but have also transformed from an advantage into a lia-

<sup>2</sup> Cf. also the discussion of the "holder" of the balance, above, pp. 142 ff.

## *Politics among Nations*

bility the concentration of population and industries on a relatively small territory in close proximity to a continent.

In the great contest between France and the Hapsburgs around which the modern state system evolved (at least until the "diplomatic revolution" of 1756 when France allied itself with the Hapsburgs against Prussia), Great Britain was able to play the controlling and restraining role of the balancer because it was strong enough in comparison with the two contenders and their allies to make likely the victory of whichever side it joined. This was again true in the Napoleonic Wars and throughout the nineteenth and the early twentieth centuries. Today Great Britain's friendship is no longer of decisive importance. Its role as the "holder" of the balance has come to an end, leaving the modern state system without the benefits of restraint and pacification which it bestowed upon that system in former times. Even as late as the Second World War, the neutrality of Great Britain or its alignment with Germany and Japan instead of with the United Nations might easily have meant for the latter the difference between victory and defeat. Now, in view of the probable trends in the technology of warfare and the distribution of power between the United States and the Soviet Union, it may well be that the attitude of Great Britain in an armed conflict between these two powers would not decisively affect the ultimate outcome. In the metaphorical language of the balance of power one might say, rather crudely but not without truth, that, while in the Russian scale there is a weight of seventy, the weight of the American scale amounts to a hundred of which seventy is the United States' own strength, ten that of Great Britain, and the remainder that of the other actual or prospective allies. Thus, even if the British weight were removed from the American scale and placed into the Russian, the heavier weights would still be in the American scale.

It follows from what has been said above that the decline of the relative power of Great Britain and its resultant inability to keep its key position in the balance of power is not an isolated occurrence solely attributable to Great Britain. Rather it is the consequence of a structural change which affects the functioning of the balance of power in all its manifestations. It is, therefore, impossible that the privileged and dominating place which Great Britain has held for so long could be inherited by another nation. It is not so much that the power of the traditional holder of the place has declined, incapacitating it for its traditional role, as that the place itself no longer exists. With two giants strong enough to determine the position of the scales with their own weight alone, there can be no chance for a third power to exert a decisive influence. It is, therefore, futile at the present moment to hope that another nation or group of nations will take the place vacated by Great Britain. Such hopes have for a time been entertained by France, and their most eloquent spokesman has been General DeGaulle. He has advocated in a number of speeches that either France alone or a United Europe under French leadership should perform the pacifying and restraining task of the "holder" of the balance between the colossus of the East and the colossus of the West. He made this point with particular emphasis in his speech of July 28, 1946, at Bar-le-Duc. He opened his address with a brilliant analysis of the transformation of the balance of power:

## *The New Balance of Power*

It is certain indeed that, with respect to what it was before this thirty-year war the face of the world has altered in every way. A third of a century ago we were living in a universe where six or eight great nations, apparently equal in strength, each by differing and subtle accords associating others with it, managed to establish a balance everywhere in which the less powerful found themselves relatively guaranteed and where international law was recognized, since a violator would have faced a coalition of moral or material interests, and where, in the last analysis, strategy conceived and prepared with a view to future conflicts involved only rapid and limited destruction.

But a cyclone has passed. An inventory can be made. When we take into account the collapse of Germany and Japan and the weakening of Europe, Soviet Russia and the United States are now alone in holding the first rank. It seems as if the destiny of the world, which in modern times has in turn smiled on the Holy Roman Empire, Spain, France, Britain and the German Reich, conferring on each in turn a kind of pre-eminence, has now decided to divide its favor in two. From this decision arises a factor of division that has been substituted for the balance of yore.

After referring to the anxieties caused by the expansionist tendencies of the United States and the Soviet Union, DeGaulle raised the question of restoring a stable balance of power.

Who then can re-establish the equilibrium, if not the old world, between the two new ones? Old Europe, which, during so many centuries was the guide of the universe, is in a position to constitute in the heart of a world that tends to divide itself into two, the necessary element of compensation and understanding.

The nations of the ancient west have for their vital arteries the North Sea, the Mediterranean, the Rhine; they are geographically situated between the two new masses. Resolved to conserve an independence that would be gravely exposed in the event of a conflagration, they are physically and morally drawn together by the massive effort of the Russians as well as by the liberal advance of the Americans. Of global strength because of their own resources and those of the vast territories that are linked to them by destiny, spreading afar their influences and their activities, what will be their weight if they manage to combine their policies in spite of the difficulties among them from age to age! <sup>3</sup>

However, it is not only the weakness of France in comparison with the United States and the Soviet Union which incapacitates it even more than Great Britain to perform that task. Above all, General DeGaulle's argument leaves out of account the decisive fact that Great Britain was capable of making its beneficial contributions to peace and stability only because it was geographically remote from the centers of friction and conflict, because it had no vital interests in the stakes of these conflicts as such, and because it had the opportunity of satisfying its aspirations for power in areas beyond the seas which generally were beyond the reach of the main contenders for power.

It was that threefold aloofness, together with its resources of power, which enabled Great Britain to play its role as "holder" of the balance. In none of these three respects is France or a United Europe aloof from the centers of

---

<sup>3</sup> *New York Times*, July 29, 1946, p. 1; cf. for later speeches, *ibid.*, June 30, 1947, p. 1, July 10, 1947, p. 3.

# THE BALANCE OF POWER IN THE EIGHTEENTH CENTURY

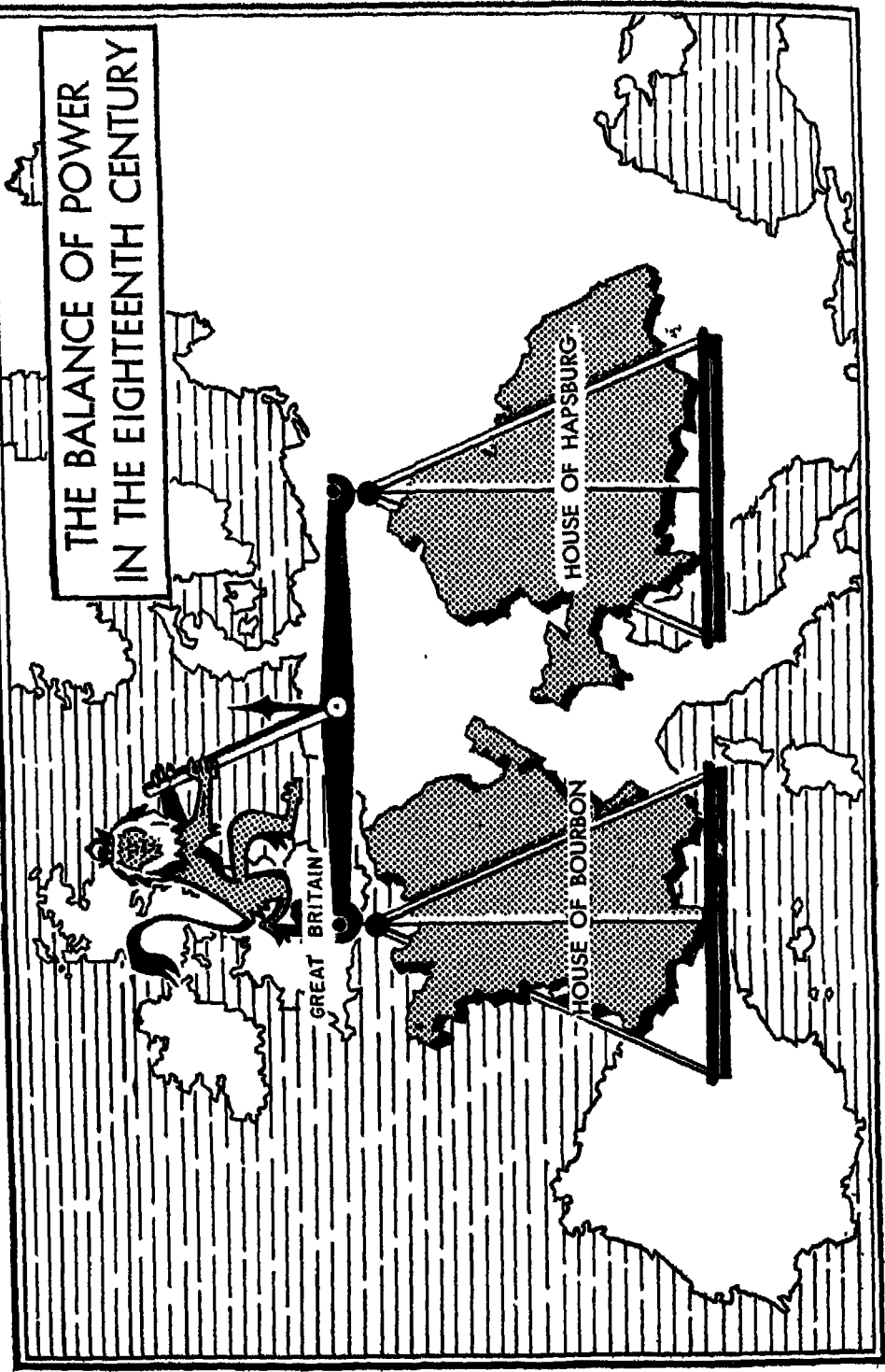

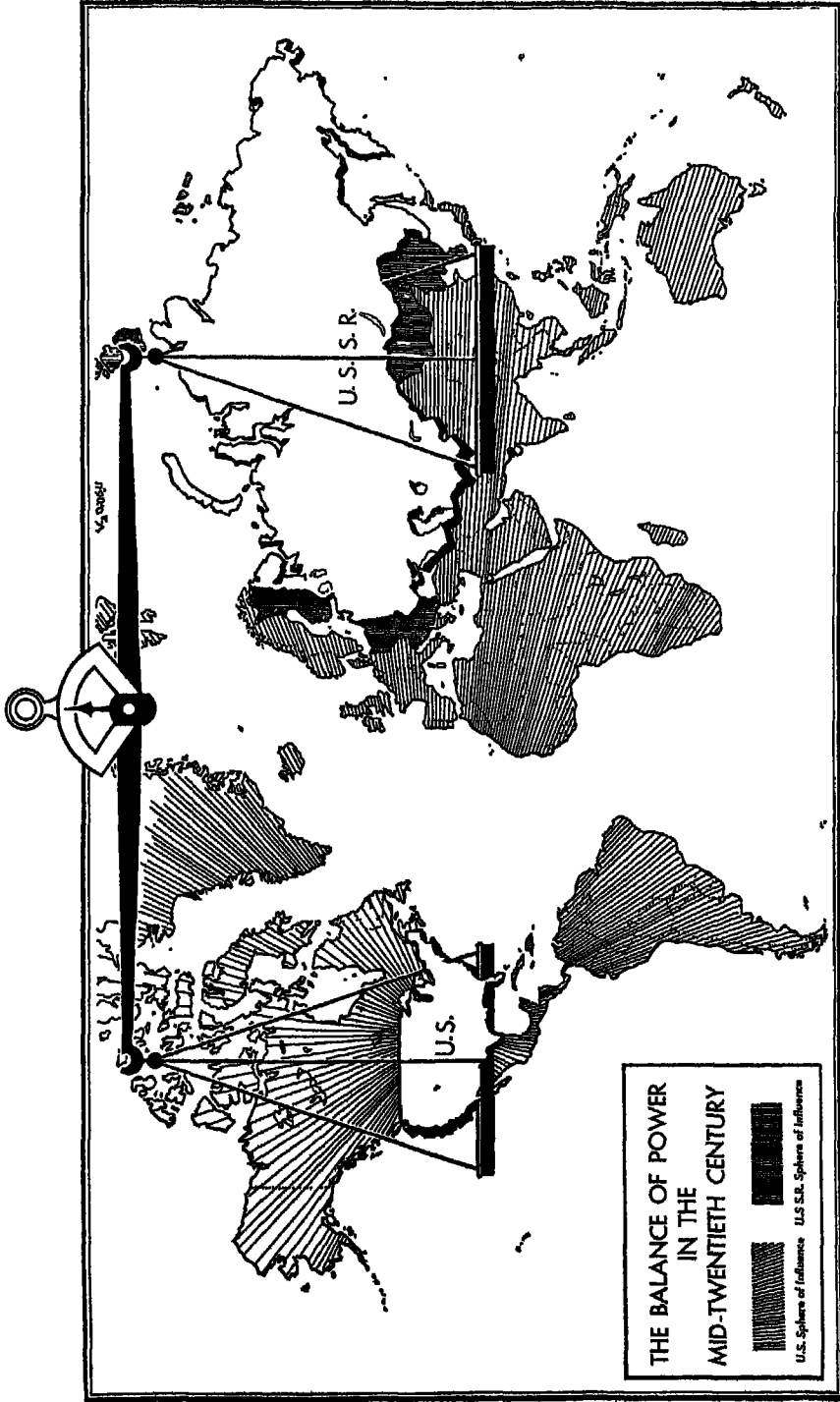



## *Politics among Nations*

conflict. Quite the contrary, they are deeply implicated in them in all three respects. For they are at once the battlefield and the prize of victory in an armed conflict between the United States and the Soviet Union. They are permanently and vitally interested in the victory of one or the other side. And they are unable to seek satisfaction for their aspirations for power anywhere but on the European continent itself. It is for these reasons that neither France nor Europe as a whole could enjoy that freedom of maneuver which the "holder" of the balance must have in order to fulfill its function.

### 3. DISAPPEARANCE OF THE COLONIAL FRONTIER

With this discussion we are broaching a third change in the structure of the balance of power, namely, the disappearance of the colonial frontier. The balance of power owed the moderating and restraining influence which it exerted in its classical period not only to the moral climate within which it operated and to its own mechanics, but also in good measure to the circumstance that the nations participating in it rarely needed to put all their national energies into the political and military struggles in which they were engaged with each other. Nations in that period sought power through the acquisition of territory, then considered the symbol and substance of national power. Trying to take land away from a powerful neighbor was one method of gaining power. There was, however, a much less risky opportunity for achieving that end. That opportunity was provided by the wide expanses of three continents: Africa, the Americas, and the part of Asia bordering on the Eastern oceans.

Throughout the history of the balance of power, Great Britain found in this opportunity the main source of its power and of its detachment from the issues which involved the other nations in continuous conflict. Spain dissipated its strength in exploiting that opportunity and thus removed itself from the struggle for power as a force to be reckoned with. What for Great Britain and Spain was a constant and major concern attracted the energies of the other nations to a lesser degree or only sporadically. The policies of France in the eighteenth century present instructive examples of the reciprocal effect of colonial expansion and imperialistic attacks upon the existing balance of power; the more intense these attacks were, the less attention was paid to colonial expansion, and vice versa. The United States and Russia were for long stages of their history totally absorbed by the task of pushing their frontiers forward into the politically empty spaces of their continents and during those periods they took no active part in the balance of power. The Austrian monarchy was too much concerned, especially during the nineteenth century, with maintaining its control over the restive non-German nationalities of Central and Southeastern Europe, which made up the bulk of its empire, to be capable of more than limited excursions into power politics. Furthermore, until deep into the eighteenth century, the threat of Turkish aggression limited Austria's freedom of movement on the chessboard of international politics. Prussia, finally, as the late-comer to the circle of the great powers, had to be satisfied with defending and securing its position as a great

## *The New Balance of Power*

power. Besides, it was too weak internally and in too unfavorable a geographical position to think of a program of unlimited expansion. Even after Bismarck had made Prussian power predominant in Germany and German power predominant in Europe, his policy was aimed at preserving, not at expanding that power.

In the period between 1870 and 1914, the stability of the status quo in Europe was the direct result, on the one hand, of the risks implicit in even the smallest move at the frontiers of the great powers themselves and, on the other, of the opportunity of changing the status quo in outlying regions without incurring the danger of a general conflagration. As Professor Toynbee observes:

At the center [of the group of states forming the balance of power], every move that any one state makes with a view to its own aggrandizement is jealously watched and adroitly countered by all its neighbors, and the sovereignty over a few square feet of territory and a few hundred "souls" becomes a subject for the bitterest and stubbornest contention. . . . In the easy circumstances of the periphery, quite a mediocre political talent is often able to work wonders. . . . The domain of the United States can be expanded unobtrusively right across North America from the Atlantic to the Pacific, the domain of Russia right across Asia from Baltic to Pacific, in an age when the best statesmanship of France or Germany cannot avail to obtain unchallenged possession of an Alsace or a Posen.<sup>4</sup>

With the unification of Germany in 1870, the consolidation of the great nation states was consummated and territorial gains in Europe could henceforth be made only at the expense of the great powers or their allies. Thereafter, for more than four decades, the great issues of world politics were connected with African names, such as Egypt, Tunis, Morocco, the Congo, South Africa, and with the decrepit Asiatic empires of China and Persia. Local wars arose as a result of these issues — the Boer War of 1899–1902 between Great Britain and the Boer Republics, the Russo-Japanese War of 1904–05 and the Russo-Turkish and Italo-Turkish Wars of 1877 and 1911–12 respectively. But it should be noted that in all these wars one of the great powers fought against what might be called a "peripheric" power, a power which was either the designated object of the former's expansion or, as in the exceptional case of Japan, an outside competitor. In no case was it necessary for a great power to take up arms against another great power in order to expand into the politically empty spaces of Africa and Asia.

The policy of compensations could here operate with a maximum of success, for there was so much political no-man's-land that one could compensate one's self and allow others to do the same. There was always the possibility of compromise without compromising one's vital interests, of retreating while saving one's face, of sidestepping and postponing. The period from 1870 to 1914, then, was a period of diplomatic bargains and horse trading for other people's lands, of postponed conflicts and sidestepped issues, and it was also the period of continuous peace among the great powers.

---

<sup>4</sup> Arnold Toynbee, *A Study of History* (London, New York, Toronto: Oxford University Press, 1934), III, 302. (Reprinted by permission of the publisher.)

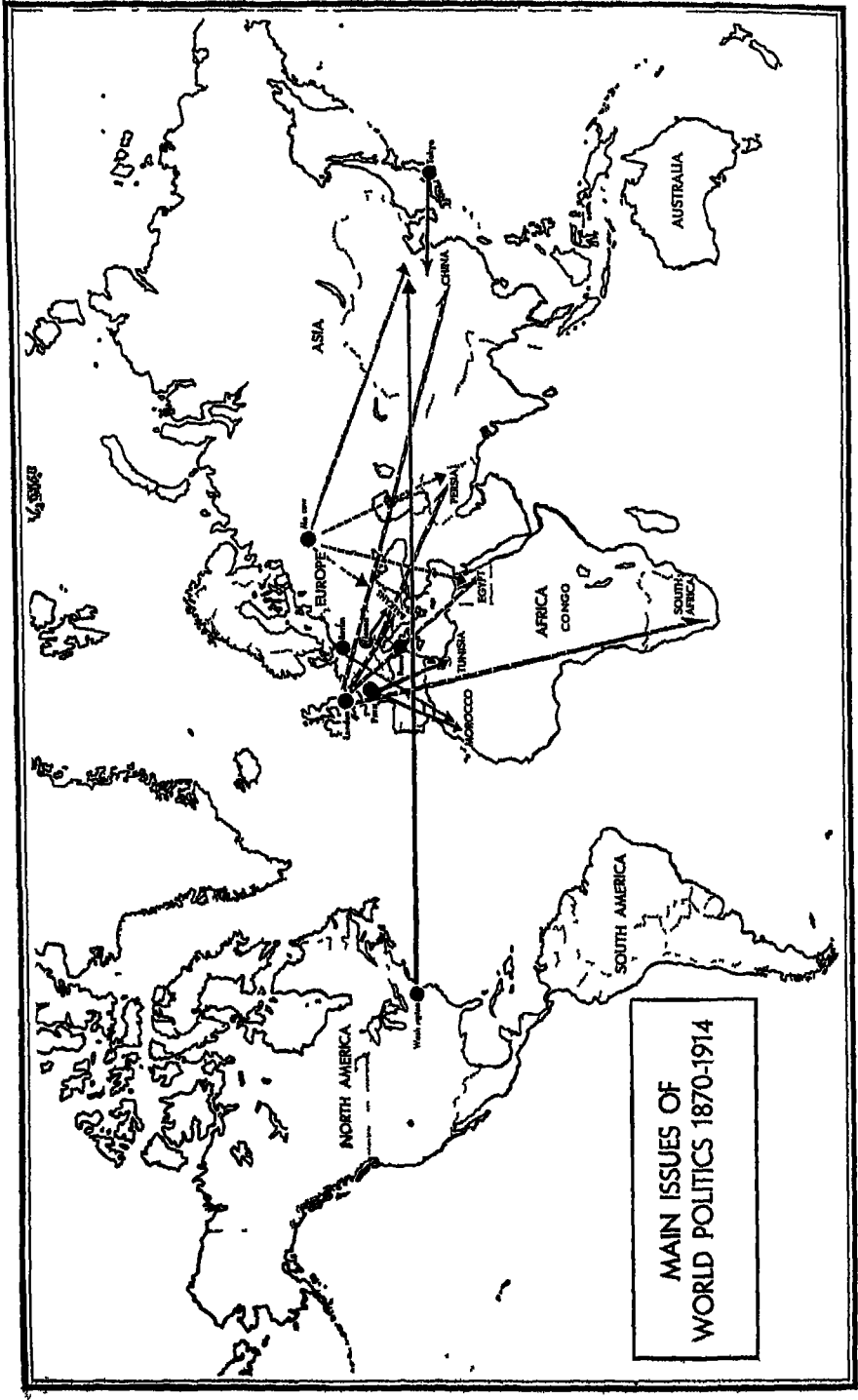

MAIN ISSUES OF  
WORLD POLITICS 1870-1914

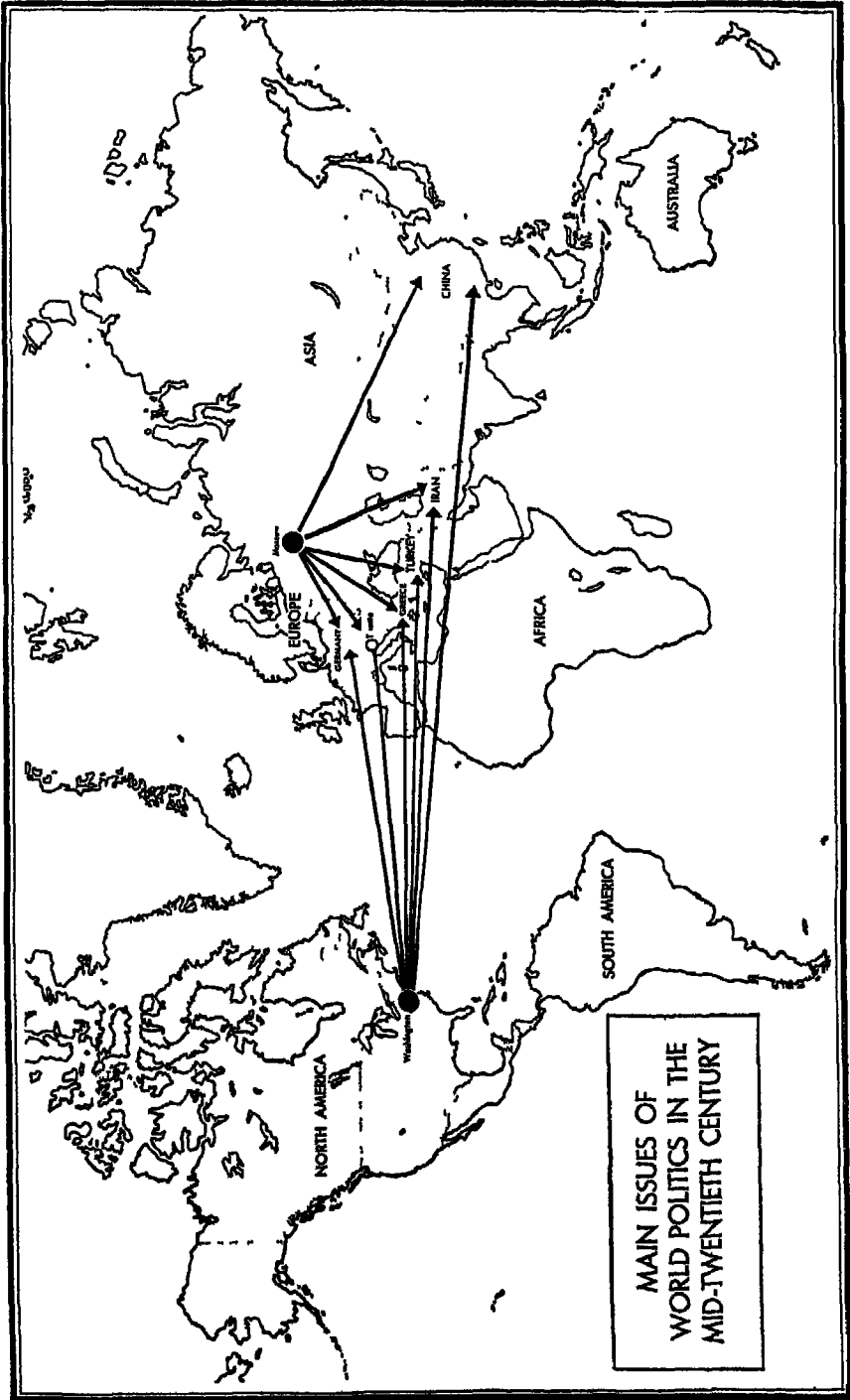

## *Politics among Nations*

Yet it is significant that the most persistent and the most explosive of the great issues of that period, while still located at the periphery of the circle of the great powers, was closer to it geographically and weighed more directly upon the distribution of political and military power within it than any other of the great issues of that epoch. That issue was how to distribute the inheritance of the European part of the Turkish Empire, also called the Eastern or the Balkan Question. Out of it arose the conflagration of the First World War. The Balkan Question more than any other issue of that period was likely to lead to open conflict among the great powers — especially since the vital interests of one of them, Austria, were directly affected by the national aspirations of Serbia. It is, however, doubtful that this outcome was inevitable. One might even plausibly maintain that if the other great powers, especially Germany, had dealt with the Balkan Question in 1914, as they had done successfully at the Congress of Berlin in 1878, that is, in recognition of its peripheric character, the First World War might well have been avoided.

When Bismarck declared in 1876<sup>5</sup> that, as far as the interests of Germany were concerned, the Balkans were not worth "the good bones of one single Pomeranian musketeer," he affirmed emphatically the peripheric character of the Balkan Question in view of the political and military interests of Germany. When the German government in July 1914 promised to support whatever steps Austria decided to take against Serbia, it did the exact opposite, and for no good reason. Germany identified itself with the Austrian interest in the prostration of Serbia as though it was its own, while Russia identified itself with Serbia's defense of its independence. Thus a conflict at the periphery of the European state system transformed itself into a struggle which threatened to affect the over-all distribution of power within that system.

Bargaining had become impossible if it was not to be the bargaining away of one's own vital interests. Concessions at somebody else's expense could no longer be made, because identification of one's own interests with the interests of the smaller nations involved had turned concessions at the apparent expense of others into concessions at one's own expense. The conflict could not be postponed because, as we have seen, most of the great powers feared that postponement would strengthen the other side for an armed conflict which was considered to be inevitable. For, once the issues had been brought from the periphery into the center of the circle of the great powers, there was no way of sidestepping them: there was, as it were, no empty space into which to step in order to evade the issue. Russia had to face the Austro-German determination to settle the Serbian problem on Austria's terms. In consequence, France had to face the invocation of the Franco-Russian Alliance by Russia, Germany had to face the activation of that alliance, and Great Britain had to face the threat to Belgium. There was no sidestepping these issues except at the price of yielding what each nation regarded its vital interests to be.

What came about in July 1914, at least in part by blundering diplomacy, has today become the ineluctable result of structural changes in the balance of power. It was possible in the period preceding the First World War for the great powers to deflect their rivalries from their own mutual frontiers to the

---

<sup>5</sup> In the session of the German Reichstag of December 5, 1876.

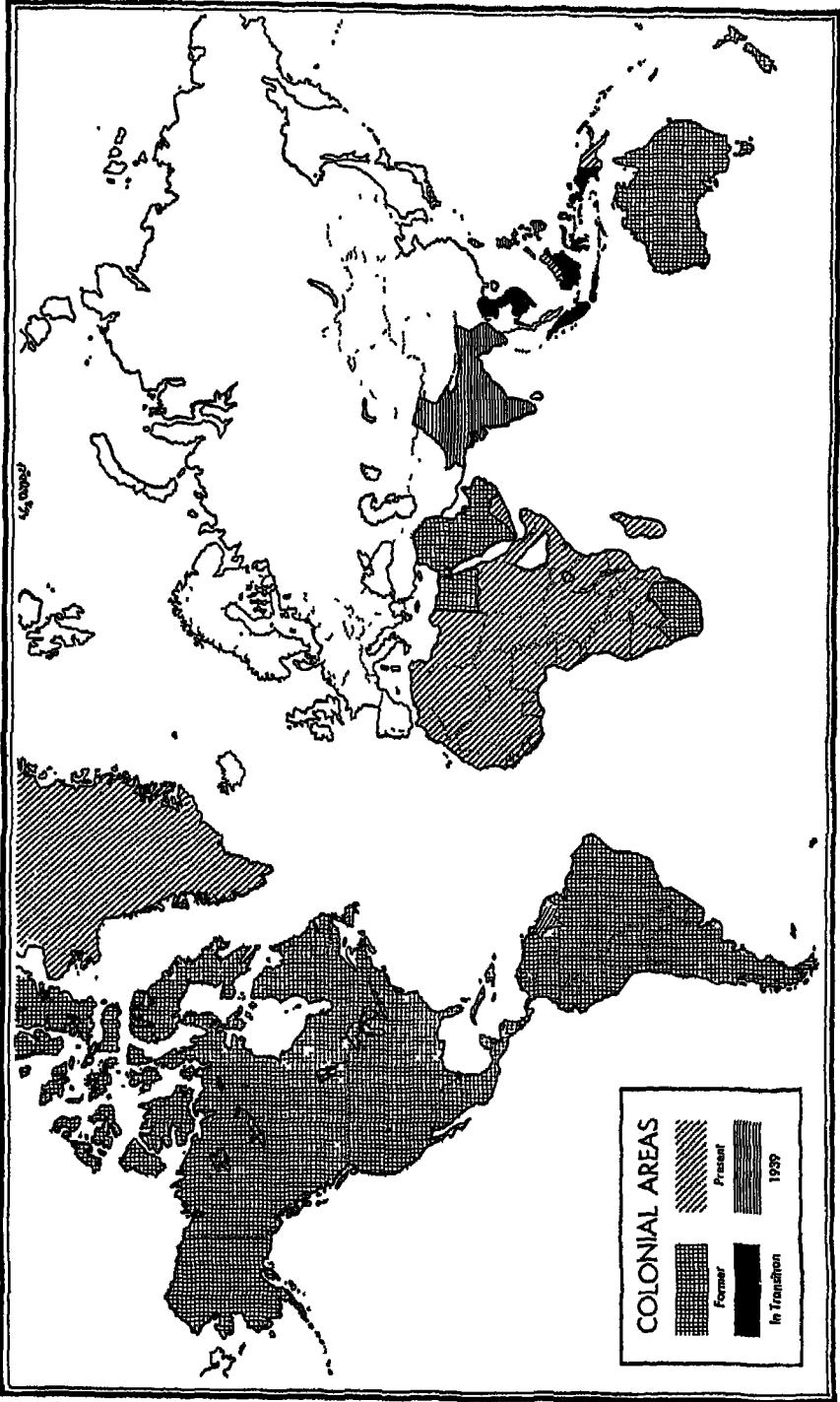

## *Politics among Nations*

periphery and into politically empty spaces because, as we have seen, virtually all the active participants in the balance of power were European nations and, furthermore, the main weights of the balance were located in Europe. To say that there were during that period a periphery of politically empty spaces is simply a negative way of saying that during that period the balance of power was quantitatively and qualitatively circumscribed by geographical limits. As the balance of power becomes world-wide with its main weights in three different continents, the American and the Eurasian, the dichotomy between the circle of the great powers and its center, on the one hand, and its periphery and the empty spaces beyond, on the other, must of necessity disappear. The periphery of the balance of power now coincides with the confines of the earth. The formerly empty spaces lie east and west, north and south, on the poles and in the deserts, on land, on water, and in the air, athwart the routes over which the two superpowers must approach each other for friendly or hostile contacts. Into those spaces the two remaining great contenders on the international scene have poured their own power, political, military, and economic, transforming those spaces into the two great blocs which border at each other and oppose each other at the four corners of the earth.

#### 4. POTENTIALITIES OF THE TWO-BLOC SYSTEM

These two blocs face each other like two fighters in a short and narrow lane. They can advance and meet in what is likely to be combat, or they can retreat and allow the other side to advance into what to them is precious ground. Those manifold and variegated maneuvers through which the masters of the balance of power tried either to stave off armed conflicts altogether or at least to make them brief and decisive yet limited in scope, the alliances and counteralliances, the shifting of alliances according to whence the greater threat or the better opportunity might come, the sidestepping and postponement of issues, the deflection of rivalries from the exposed frontyard into the colonial backyard—these are things of the past. With them have gone into oblivion the peculiar finesse and subtlety of mind, the calculating and versatile intelligence and bold yet circumspect decisions which were required from the players in that game. And with those modes of action and intellectual attitudes there has disappeared that self-regulating flexibility, that automatic tendency, of which we have spoken before,<sup>6</sup> of disturbed power relations either to revert to their old equilibrium or to establish a new one.

For the two giants which today determine the course of world affairs only one policy seems to be left, that is, to increase their own strength and that of their satellites. All the players that count have taken sides, and in the foreseeable future no switch from one side to the other is likely to take place, nor, if it were to take place, would it be likely to reverse the existing balance of power. Since the issues everywhere boil down to retreat from, or advance into, areas which both sides regard as of vital interest to themselves, positions must

---

<sup>6</sup> See above, pp. 125, 126.

## *The New Balance of Power*

be held, and the give and take of compromise becomes a weakness which neither side is able to afford.

While formerly war was regarded, according to the classic definition of Clausewitz, as the continuation of diplomacy by other means, the art of diplomacy is now transformed into a variety of the art of warfare. That is to say, we live in the period of "cold war" where the aims of warfare are being pursued, for the time being, with other than violent means. In such a situation the peculiar qualities of the diplomatic mind are useless, for they have nothing to operate with and are consequently superseded by the military type of thinking. The balance of power, once disturbed, can be restored only, if at all, by an increase in the weaker side's military strength. Yet, since there are no important variables in the picture aside from the inherent strength of the two giants themselves, either side must fear that the temporarily stronger contestant will use its superiority to eliminate the threat from the other side by shattering military and economic pressure or by a war of annihilation.

Thus, as we approach the mid-twentieth century, the international situation is reduced to the primitive spectacle of two giants eyeing each other with watchful suspicion. They bend every effort to increase their military potential to the utmost, since this is all they have to count on. Both prepare to strike the first decisive blow, for if one does not strike it the other might. Thus contain or be contained, conquer or be conquered, destroy or be destroyed, become the watchwords of the new diplomacy.

That such is today the political state of the world does not of necessity result from the mechanics of the new balance of power. The changed structure of the balance of power has made the hostile opposition of two gigantic power blocs possible, but it has not made it inevitable. Quite the contrary, the new balance of power is a mechanism which contains in itself the potentialities for unheard-of good as well as for unprecedented evil. Which of these potentialities will be realized depends not upon the mechanics of the balance of power, but upon moral and material forces which use that mechanism for the realization of their ends.

The French philosopher Fénelon, in his advice to the grandson of Louis XIV, from which we have quoted before,<sup>7</sup> gave an account of the different types of the balance of power. In assessing their respective advantages and weaknesses, he bestowed the highest praise upon the opposition between two equally strong states as the perfect type of the balance of power. He said:

The fourth system is that of a power which is about equal with another and which holds the latter in equilibrium for the sake of the public security. To be in such a situation and to have no ambition which would make you desirous to give it up, this is indeed the wisest and happiest situation for a state. You are the common arbiter; all your neighbors are your friends, and those that are not make themselves by that very fact suspicious to all the others. You do nothing that does not appear to have been done for your neighbors as well as for your people. You get stronger every day; and if you succeed, as it is almost inevitable in the long run by virtue of wise policies, to have more inner strength and more alliances than the power jealous of you, you ought to adhere more and more to that wise moderation which has limited you to maintaining the equilibrium and

---

<sup>7</sup> See above, pp. 160, 161.



## *Politics among Nations*

the common security. One ought always to remember the evils with which the state has to pay within and without for its great conquests, the fact that these conquests bear no fruit, the risk which one runs in undertaking them, and, finally, how vain, how useless, how short-lived great empires are and what ravages they cause in falling.

Yet since one cannot hope that a power which is superior to all others will not before long abuse that superiority, a wise and just prince should never wish to leave to his successors, who by all appearances are less moderate than he, the continuous and violent temptation of too pronounced a superiority. For the very good of his successors and his people, he should confine himself to a kind of equality.<sup>8</sup>

The distribution of power which Fénelon envisaged distinctly resembles the distribution of power which exists, as we approach the mid-twentieth century, between the United States and the Soviet Union. It is a potential equilibrium with the preponderance at present on the side of the United States. The beneficial results which the French philosopher contemplated have, however, failed to attend this potential equilibrium between the United States and the Soviet Union, and they do not seem likely to materialize in the foreseeable future. The reason is to be sought in the character of modern war which, under the impact of nationalistic universalism and modern technology, has undergone far-reaching changes. It is here that we find the fifth and last of the fundamental changes which distinguish the world politics of the mid-twentieth century from the international politics of previous ages.

---

<sup>8</sup> *Loc. cit.*, pp. 349-50.

## CHAPTER XX

# *Total War*

We have already pointed out that war in our time has become total in four different respects: with respect to (1) the fraction of the population completely identified in its emotions and convictions with the wars of its nation, (2) the fraction of the population participating in war, (3) the fraction of the population affected by war, and (4) the objective pursued by war. When Fénelon wrote at the beginning of the eighteenth century, war was limited in all these respects and had been so limited since the beginning of the modern state system.

Let us take as an extreme example of this type of limited warfare the Italian wars of the fourteenth and fifteenth centuries. These wars were fought primarily by mercenaries who, their interests being in the main financial, were not eager to die in battle or to invite that risk by killing too many of their enemies. Furthermore, the *condottieri*, the leaders of the contending armies, were not interested in sacrificing their soldiers, for the soldiers constituted their working capital. They had invested money in their armies and they wanted them to remain going concerns. Nor did the *condottieri* want to kill many enemy soldiers, for as prisoners they could be sold for ransom or hired as soldiers for their own armies, but they could not be put to financial gain after they had been slain. The *condottieri* were not interested in decisive battles and wars of annihilation, for without a war and without an enemy there was no job. In consequence, these Italian wars consisted in good measure in skilled maneuvers and tactical artifices to compel the enemy to give up his positions and retreat, losing prisoners rather than wounded or dead.<sup>1</sup> Thus Machiavelli can report a number of fifteenth-century

---

<sup>1</sup> Cf. the description by Sir Charles Oman, *A History of the Art of War in the Middle Ages* (London: Methuen and Company, Ltd., 1924), II, 304: "For the combatants had no national or religious hatred for each other, and generally not even personal hatred, though some *condottieri* were jealous of others, or had old grudges of treachery or insult against them. But the men-at-arms of each host had probably served half a dozen times side by side with their enemies of the moment, since the bands were always passing into the pay of new employers. They might often be old friends of the particular squad against whom they were tilting. And even if this were not the case, all mercenaries were more or less brothers in arms, and despised the tyrant or the *bourgeoisie* which paid them. Moreover, a prisoner was worth to his captor not only the value of his horse and armour, but also a ransom, while a dead man could pay nothing. Hence victories became ridiculous — a tactically beaten corps made no great effort to escape, because surrender meant no more than pecuniary loss. And there was a possibility that the victor might offer them the chance of enlisting in his ranks — in which case the captive would not even lose horse and arms."

## Politics among Nations

battles, some of great historic significance, in which either nobody at all or only one man was killed, and he not by enemy action but by accident.

Machiavelli's account may be exaggerated, and the Italian wars of the fourteenth and fifteenth centuries may have been examples of traditional warfare,<sup>2</sup> but there can be no doubt that those wars were the manifestations of a type of limited war which has prevailed, with the sole significant exception of the Wars of Religion and the Napoleonic Wars, throughout modern history up to the First World War. One of the great military leaders of the eighteenth century, the Marshal of Saxe, proclaimed the very same principle of warfare that guided the *condottieri* of the fourteenth and fifteenth centuries, when he said: "I am not at all in favor of battles, especially at the beginning of a war. I am even persuaded that an able general can wage war all his life without being compelled to give battle." And at the turn of that century, Daniel Defoe, author of *Robinson Crusoe*, observed: "Now it is frequent to have armies of fifty thousand men of a side at bay within view of one another, and spend a whole campaign in dodging, or, as it is genteely called, observing one another, and then march off into winter quarters."<sup>3</sup>

On the other hand, when that epoch of limited war had come to a close, Marshal Foch, in lectures given in 1917 at the French War College, summed up the old and the new — total — type of war:

Truly a new era had begun, that of national wars which were to absorb into the struggle all the resources of the nation, which were to be aimed not at dynastic interests, not at the conquest or possession of a province, but at the defense or spread of philosophic ideas first, of principles of independence, unity, immaterial advantages of various kinds afterwards. They were destined to bring out the interest and faculties of each soldier, to take advantage of sentiments and passions never before recognized as elements of strength. . . . On the one side: intensive use of human masses fired by strong feelings, absorbing every activity of society and conforming to their needs the material parts of the system, such as fortifications, supplies, use of ground, armament, encampments, etc.

On the other side, the 18th century side: regular and methodical use of these material parts which become the foundation of various systems, differing of course with time but aiming always to control the use of troops, in order to preserve the army, property of the sovereign, indifferent to the cause for which it fights but not without some professional qualities, especially as regards military spirit and tradition.<sup>4</sup>

It is significant in this context that the phrase Fénelon used in the early eighteenth century to characterize the battles of the religious wars — "Either you are vanquisher or vanquished"<sup>5</sup> — reappears in Foch's characterization of the new total wars of the twentieth century: "A decision by arms, that is, the only judgment that counts because it is the only one that makes a victor or a vanquished; it alone can alter the respective situations of the opponents,

---

<sup>2</sup> Contemporaries distinguished between "good" and "bad" wars, the former corresponding to the type of war discussed in the text, the latter referring to the ferocity of the Swiss, especially in their encounters with German *landsknechts*, who reciprocated in kind.

<sup>3</sup> Quoted after John U. Nef, "Limited Warfare and the Progress of European Civilization, 1640-1740," *The Review of Politics*, VI (July, 1944), 277.

<sup>4</sup> Ferdinand Foch, *The Principles of War* (New York: H. K. Fly, 1918), pp. 31-2.

<sup>5</sup> Fénelon, *id.*

the one becoming master of his actions while the other continues subject to the will of his adversary. . . . If the defeated side only comes to terms when it has no means left of discussion, the aim must be to destroy its means of discussion.”<sup>6</sup>

## I. WAR OF TOTAL POPULATIONS

That in the new age of warfare the masses of individual citizens identify themselves fully with the wars in which their country is engaged is strikingly illustrated by two factors, one moral, the other empirical.

The moral factor is the revival, in the twentieth century, of the doctrine of just war, that is to say, of the distinction between belligerents whose participation in war is justified in ethics and law, and those who are not considered to have the legal and moral right to take up arms. This doctrine dominated the Middle Ages, but with the ascendancy of the modern state system it was watered down to the vanishing point. As Professor Ballis has pointed out in reference to the development of the doctrine in the sixteenth century: “The notion of the mediaeval schoolmen on a just war—guilt on one side and righteousness on the other—practically vanished. There came in its place the idea that the Sovereign was to make war as an accuser and as a judge.” As a result, the new doctrine “widened by casuistry the chances for making virtually any kind of war just.”<sup>7</sup>

Throughout the period of limited warfare, the distinction between just and unjust war remained at best ambiguous and was finally abandoned in the nineteenth century when war was considered to be a mere fact, the conduct of which was subject to certain moral and legal rules, but of which all states had a legal and moral right to avail themselves at their discretion. In this view, war was an instrument of national and, more particularly, of dynastic policy to be used alternately or simultaneously with diplomacy, as the government saw fit.

For the masses of a people to identify themselves wholly with such a war was obviously impossible. For such an identification a moral issue was needed for whose defense or attainment war was to be waged. In other words, war had to be just on one's own side and unjust on the side of the enemy in order to evoke moral enthusiasm in support of one's own cause and hostile passion against the enemy. Perhaps soldiers of fortune and professionals would be willing to lay down their lives without this justification, but not citizens-in-arms. Nationalism in the Napoleonic Wars and in the German and Italian wars of national unification in the nineteenth century, and nationalistic universalism in the two world wars of the twentieth have supplied that principle of justice and, with it, that passion and enthusiasm which have restored to masses of fighting men the willingness to conquer and die for an idea.

The vehicle upon which the ideas of nationalism and nationalistic universalism rode to victory was universal military service through conscription.

<sup>6</sup> *Op. cit.*, pp. 42-3, 39.

<sup>7</sup> William Ballis, *The Legal Position of War Changes in its Practice and Theory from Plato to Vattel* (The Hague: Nijhoff, 1937), pp. 102-3.

## *Politics among Nations*

Neither mercenaries nor the riff-raff pressed into military service nor the good people kidnapped into it, which made up the rank and file of armies in the period of limited warfare, could be expected to be inspired by moral and ideal considerations. Their main interest to avoid battle and stay alive coincided with the desire of their leaders to keep the financial investment and the risks low by trying to win wars through maneuvering rather than fighting. Under Frederick the Great, two-thirds of the Prussian Army were recruited from foreign mercenaries. One-third of the Prussian Army which opposed the armies of the French Revolution in 1792 still consisted of mercenaries, and its inept maneuvering, aimed primarily at the avoidance of battle, corresponded well to the spirit of its soldiers who did not know for or against what they fought. "The French system of conscription," said the Duke of Wellington referring to the French and English armies of that period, "brings together a fine specimen of all classes; our army is composed of the scum of the earth — the mere scum of the earth."

During the period of limited warfare, desertions not only of individuals but of whole units were common. A mercenary or an army of mercenaries would serve one employer in the spring and another in the fall, according to the benefits to be expected. If his contract was only for one fighting season, this procedure was perfectly regular, yet he would not hesitate to follow it regardless of contractual obligations if he was dissatisfied with the wages and working conditions under his old master.

It was especially effective in labor disputes of this kind for a contingent of mercenaries to look for another employer immediately before a battle or during a siege. Thus in 1521, at the siege of Parma, three thousand Italians deserted the French Army and went over to the other side. In October 1521, the Swiss contingent of the French Army in Italy was within a few weeks reduced through desertion from twenty thousand to six thousand men. The following spring, the new contingent of Swiss went on strike the day before the battle of Bicocca, virtually dictating the French battle plan, with the result that the Swiss attack was beaten back and the battle lost. In the opposing camp during the same battle, the German contingent is reported to have demanded double pay for staging a counterattack, neither of which was forthcoming. A few days before the battle of Pavia in 1525, six thousand Swiss and two thousand Italians left the French Army, although they had received their full pay. Their desertion reduced the strength of the French Army by almost one-third.

During the religious wars of the sixteenth and seventeenth centuries, whole armies changed sides time and again. In the eighteenth century, the losses which armies suffered from desertion exceeded the losses in battle, and the practice was so widespread that it was inadvisable for armies to camp or maneuver in poorly visible terrain and in other than close formation. To keep enough men in the field, Frederick the Great was forced to pay rewards to deserters who returned to their units within six months.

Military service was widely used as alternative punishment for crimes. The Landgrave of Hesse, for instance, who was opposed to capital punishment, used to send criminals under sentence of death to his regiment, and it was general practice to give insolvent debtors the alternative between serving

their sentence or enlisting in the army. The general contempt in which armies of this kind were held was commensurate with their morale. They were, as a contemporary of Frederick the Great put it, "animated neither by a spirit of patriotism nor by loyalty to their prince." They were kept together only by iron discipline and the prospect of rewards, and in view of their social origin, their social prestige, and the character of the wars fought by them, this could not have been otherwise.<sup>8</sup>

In order to have an army which was capable of identifying itself wholly with the cause of a war, it was necessary to have a cause which could unite a large mass of men behind it and an army which was homogeneous in terms of that cause. When Protestants and Catholics fought each other over the issue of whose religion should prevail, the unifying cause and the mass capable of being unified under that cause had materialized. When, in the period of limited warfare, wars were fought for the succession to a throne, the possession of a province or town, or the glory of the monarch, the two prerequisites were present for that fraction of the nobility which considered military service for the monarch as its hereditary privilege, but for nobody else. With the defense by the French nation-in-arms of the revolutionary freedoms against foreign aggression, a homogeneous army again had a cause to which it could be loyal and for which it was willing to die. The French law of 1793, making military service compulsory for all able-bodied men between the ages of eighteen and twenty-five, was the first legislative recognition of the new character of war.

While even an army originating in universal military service might fail to identify itself wholly with the cause of the war it is fighting, it can safely be said that as a rule only an army so constituted will be fully capable of that identification. Thus it is not by accident that the period of limited warfare coincides with a morally indifferent conception of war fought by heterogeneous armies whose main cohesive force was compulsion and the love of adventure and money, while, on the other hand, total war is coeval with the nation-in-arms imbued with the conviction of the justice of the war it is fighting.

Thus it was only consistent that, with the termination of the Napoleonic period and the restoration of the Bourbons and their dynastic foreign policies, conscription was abolished in France to be re-established only by the Third Republic. What the law of 1793 was for France, the laws of 1807 and of the following years were for Prussia. They abolished the hiring of mercenaries,

<sup>8</sup> Another variety of a limited war, of which the British were masters, has been well described by an anonymous author in the *Edinburgh Review*, Vol. I, January 1803, p. 357: "Those states, which are the most injured by the operations of war, are also the richest in superfluous stock. They have contrived a species of pecuniary commutation of war, similar to the commutation of military service, which paved the way for the introduction of standing armies: they have managed to turn off the battle from their gates, by paying less wealthy allies for fighting in their cause at a safe distance. The operations of war are in this manner rendered very harmless, and a foundation is laid for their gradual disuse. A few useless millions, and a few still more useless lives are sacrificed; the arts of peace continue to flourish, sometimes with increased prosperity; and the policy of preferring to purchase defeat at a distance, rather than victory at home—of paying allies for being vanquished, rather than gain the most splendid triumphs on their own ground—has been amply rewarded by the safety, increased resources, and real addition of power, which results from an enjoyment of all the substantial blessings of peace, with the only real advantages of necessary warfare."

## *Politics among Nations*

prohibited the enlistment of foreigners, and culminated in the law of 1814 proclaiming the duty of every citizen to defend his country. Both the France of the revolution and the Prussia of the war of liberation used conscription as an instrument of the national spirit against foreign aggression, the former against the Prussia of the *ancien régime*, the latter against the France of Napoleonic imperialism.

### 2. WAR BY TOTAL POPULATIONS

When in the twentieth century the character of war again changes and its purpose transforms itself from national liberation and unification into nationalistic universalism, the participation of the population in war is correspondingly enlarged. Now not only able-bodied men are conscripted, but, in totalitarian countries, women and children as well. In the non-totalitarian countries, the auxiliary services of women — Wacs, Waves, and the like — are asked for on a voluntary basis. Everywhere, however, all the productive forces of the nation are harnessed to the purposes of warfare. Whereas, in the period of limited warfare, war was of little concern to the population at large, which was primarily affected by it through increased taxation, the wars of the twentieth century have become everybody's business, not only in the sense of nationalistic identification, but also of military or economic participation.

Two factors are responsible for this development: the increase in the size of armies and the mechanization of warfare. The size of armies has increased enormously in the twentieth century, both absolutely and relative to the total population. In the sixteenth, seventeenth, and eighteenth centuries, the size of armies, while steadily increasing, was counted in the tens of thousands. In the Napoleonic Wars, some armies reached a number of several hundred thousand men. In the First World War, armies for the first time passed the million mark, and the Second World War saw military establishments in excess of ten million men.

The proportion of the population engaged in military service in the different periods of modern history roughly corresponds to these absolute figures. To mobilize 1 per cent of the population for military services in the seventeenth and eighteenth centuries was an enormous undertaking which was rarely achieved; on an average no more than one-third of 1 per cent of the population was mobilized during that period. In the First World War, the great European powers called 14 per cent of their populations to arms. In the Second World War, the corresponding figure for the main belligerents was rather low. It exceeded 10 per cent probably only in the case of the United States, the Soviet Union, and Germany. This decrease is accounted for by the enormously increased mechanization of warfare.

Mechanization in weapons, supplies, transportation, and communications, together with the increase in size (which even at 10 per cent of the population is still ten times more than the maximum attained in previous centuries) requires the productive effort of virtually the total working population if the military establishment is to be kept fit for war. It has been estimated that the productive efforts of at least a dozen men are needed for one man actually

engaged in warfare. Since in the Second World War the armed forces of the great military powers, such as Germany, the Soviet Union, and the United States, exceeded ten million, the numbers of the civilian population supplying each of them with weapons, transportation, communications, clothing, and nourishment must have exceeded one hundred million by a considerable margin. Thus modern war has indeed become war by total populations.

### 3. WAR AGAINST TOTAL POPULATIONS

War has become total not only in the sense of everybody being a prospective participant in war, but also in the sense of everybody being a prospective victim of warfare. The comparative figures of losses in war, unreliable though they are in detail, are eloquent on that point. To take France as the nation which in modern history has been regularly engaged in the great wars of the epoch and to take as example the percentage, computed by decades, of the population of France killed or wounded in war from 1630 to 1919, we find that from 1630 to 1789, the outbreak of the French Revolution, the maximum is 0.58, the minimum 0.01 per cent. In the period from 1790 to 1819, which is roughly the period of the Napoleonic Wars, the figure rises steeply to 1.48, 1.19, 1.54 per cent, respectively, while it sinks in the period from 1820 to 1829, coincident with the revival of dynastic foreign policies, to the all-time low of 0.001. While the figures for the remainder of the nineteenth century fit closely into the general picture presented by the whole period, the figure for the second decade of the twentieth century, the period of the First World War, rises to the all-time high of 5.63 per cent. It is also significant that while the whole period from 1630 to 1829 shows only for one decade, 1720-29, no war losses at all, there are five such decades in the nineteenth century alone, the century of colonial expansion.

The picture is similar when we consider the figures for deaths in military service by centuries. The figures for Great Britain show the typical curve, slumping in the nineteenth century and rising steeply in the twentieth century. Great Britain had fifteen deaths in military service per thousand deaths for the total population in the seventeenth century, fourteen in the eighteenth, six in the nineteenth, and forty-eight in the twentieth up to 1930. The corresponding figures for France show a considerable rise in the eighteenth and no slump in the nineteenth century on account of the interruption of the period of limited warfare by the Napoleonic Wars. The figures are eleven for the seventeenth century, twenty-seven for the eighteenth, thirty for the nineteenth, and sixty-three for the twentieth up to 1930. The destructiveness of modern war, expressed in these figures, is still more strikingly revealed by the fact that in the preceding centuries by far the greater part of military losses was caused by diseases rather than by armed action. In consequence, losses through military action have increased relatively and absolutely to an enormous extent in the twentieth century.

Unprecedented since the end of the religious wars are the losses which the civilian populations have suffered through military action in the wars of the twentieth century. There can be little doubt that the total civilian losses due



## *Politics among Nations*

to military action in the Second World War surpass the total military losses. The number of civilians killed by the Germans through measures of deliberate extermination alone are estimated at close to twelve million. The French record of 5.63 per cent of the total population killed or wounded in the First World War has not even been approximated by France in the Second World War because of the relatively minor role it played in the military operations. But that record has been left far behind by the Soviet Union which must have lost during the Second World War in killed and wounded close to 10 per cent of the total population, that is, almost double the percentage of the French losses in the First World War.<sup>9</sup> Thus the trend toward an enormous increase in the destructiveness of modern war, to which the figures for the First World War testify, has continued in the Second at an accelerated pace. The invention of new destructive methods of warfare, either not used at all in the preceding world wars, such as bacteriological warfare, or used only on a small scale, such as poison gas, guided missiles, and atomic bombs, seems to insure a continuation and further acceleration of that trend.

#### 4. THE MECHANIZATION OF WARFARE

(The enormously increased destructiveness of twentieth-century warfare, for combatants and civilians alike, is the result of the mechanization of warfare. Its effects in this respect are twofold: the ability to eliminate an unprecedented number of enemies through one single operation or the accelerated multiple operation of a weapon, and the ability to do so over long distances. Both developments started in the fourteenth century with the invention of gunpowder and its use for artillery. But it was only in the late nineteenth century that these developments were speeded up to a considerable extent, and only our time has witnessed such an enormous acceleration of these trends as to amount to a revolution in the technology of war.)

The extreme slowness of these developments in the first six centuries of their history and the extreme rapidity in the seventh is illustrated by the history of artillery. The guns with which the Turks besieged Constantinople in 1453 could fire bullets weighing eight hundred pounds at a range of a mile, their rate of fire being seven rounds per day and one per night. In 1650 a cannon carrying a nine-pound shot had a point blank range of 175 yards, while two hundred years later the same range of an English nine-pounder smooth-bore was 300 yards. At the end of the eighteenth century, artillery was still regarded in most countries, with the one notable exception of France, as a subordinate and somewhat unbecoming weapon with which a gentleman would rather have nothing to do. Even Frederick the Great asked contemptuously what was valuable about artillery, and what art there was in shooting well. Yet, only a few decades later, Napoleon could say: "It is with

---

<sup>9</sup> As to the contradictory figures of the Russian losses, see Dudley Kirk, *Europe's Population in the Interwar Years* (Series of League of Nations Publications, II. Economic and Financial, 1946. II. A. 8), p. 69, note 24, p. 70, note 28; *The World Almanac* (1946), p. 44; (1947), p. 521; (1948), p. 552. The estimate in the text is derived from the preponderant estimates in these sources.

the artillery that war is made," and it has been estimated that in the century following this remark the efficiency of artillery increased ten times.

The low esteem of the most potent and, together with the musket, lone representative of the mechanization of warfare remained traditional in the Prussian Army. In the eighteenth century, this contempt may not have been altogether without justification in view of the extreme slowness of loading, the inaccuracy of the aim, and the limited range (a maximum of 2,000 yards). But the nineteenth century witnessed a progress in the rapidity of fire and the range of firearms which foreshadowed the revolution of the twentieth. While, for instance, in 1850 the number of bullets fired by a smooth-bore muzzle loader by a thousand men in one minute was 500 and their range about the same as it had been for the musket of the sixteenth, seventeenth, and eighteenth centuries, that is, less than 300 yards, the corresponding figures for the needle gun are 1,000 rounds and 2,200 yards; for the model 1866, 2,000 rounds and 2,700 yards; for the model 1886, 6,000 rounds and 3,800 yards; and for the repeating rifle with charger in 1913, 10,000 rounds and 4,400 yards. Between 1850 and 1913, the rapidity of fire had increased twentyfold and the range expanded sixteen times. Yet today we have machine guns which fire 1,000 rounds a minute, making 1,000,000 for a thousand men where there were only 10,000 in 1913, and even semiautomatic shoulder rifles, such as the Garand, are able to fire 100 aimed rounds per minute, that is, ten times more than the fastest small arms in 1913.

(How great the progress made in this respect was between 1850 and 1913, and how overwhelming between 1913 and 1938, becomes apparent from a comparison with the slow progress made between 1550 and 1850.) In the mid-sixteenth century, the range of the hand cannon was about one hundred yards, and one round in two minutes was about the best rate of fire attainable. While in the First World War the maximum range of heavy artillery — with great inaccuracy in aim and excessive wear on the gun which was worn out after a maximum of thirty rounds — did not exceed 76 miles (attained only by the German forty-two centimeter guns), at the moment of this writing guided missiles, that is, containers of explosives traveling under their own power, with a range of 250 miles are available. The range of a fully loaded bomber capable of returning to its base after the execution of its mission was in the neighborhood of 1,500 miles at the end of the Second World War and has since been increased to exceed 2,000 miles. Thus, while at the turn of the century the maximum distance within which a nation could attack a point in enemy territory was a few miles, it had increased in the First World War to 76 miles for artillery and a few hundred miles for — ineffective and lightly loaded — aircraft, and in the Second World War to about 1,500 miles and stands now at somewhat more than 2,000.

Yet if one considers the range of aircraft not in terms of their ability to return to their point of departure, but in absolute terms, the range of aircraft as a weapon has already for all practical purposes become limitless. For the maximum range of an airplane at the moment of writing being 10,000 miles, there is obviously no place on earth which cannot be reached by air from any other place, provided the airplane is not expected to return to its base. More particularly, the distance between New York and Moscow over the Great

## *Politics among Nations*

Circle Route is only 4,800 miles and the distance between any major city either in the United States and the Soviet Union and the other country's territory hardly exceeds 6,000 miles. Consequently, an American or Russian airplane, even operating under less than optimum conditions and carrying a substantial load of bombs, is able to drop its load over any major city of the other country or, for that matter, of any country. (Warfare in the mid-twentieth century, then, has become total in that virtually the whole earth is apt to be made the theater of operations by any country fully equipped with the technological instruments of the age.)

The extension of the range of instruments of war to the whole earth can mean much or little for the character of modern war and its bearing upon contemporary world politics according to whether or not the increase in the destructiveness of war has kept pace with the increase in the range of its weapons. Through the enormous increase in destructiveness which has actually occurred during this century and, more particularly, in its fifth decade, modern war has transformed the potentialities of the total range of its weapons into the actuality of total war.

Until the invention of artillery and aside from naval warfare, one military operation by one single man was as a matter of principle capable of eliminating no more than one single enemy. One strike with a sword, one thrust with a spear or a pike, one shot from a musket would at best yield one disabled enemy. The first step toward mechanization taken at the end of the Middle Ages when gunpowder was used in warfare did not at first increase the ratio of one to one between military operation and eliminated enemy. Rather the reverse was the case. The loading and firing of an early musket, for instance, required as many as sixty different motions, executed generally by more than one man, and then the aim was so poor that only a small percentage of the shots fired would hit the target, eliminating one man. As for cannon, a considerable number of men were needed to bring it into position and load it and the poorness of the aim vitiated much of that collective effort. When a shot hit the target, however, the victims of one shot were at best counted by hardly more than the score.

The situation changed rapidly only with the invention of the improved machine gun in the later part of the nineteenth century. With this weapon one man in one operation could fire hundreds of rounds with the optimum effect of eliminating in one operation nearly as many enemies as there were shots fired. The radical improvement of artillery, starting in about the same period, and succeeding developments in the fields of air and gas warfare brought about a considerable increase in the number of enemies capable of elimination in one operation by one or very few men. The number was certainly still to be counted by the hundreds in the First World War, whose staggering losses are in the main accounted for by the machine gun mowing down charging infantry. Even during virtually the whole of the Second World War the number of victims of one direct hit by a block-buster could hardly have exceeded the thousand mark.

Atomic warfare and, as a potentiality, bacteriological warfare have wrought in this respect a revolution similar to, yet far exceeding in magnitude, the

one which the machine gun had brought about a few decades earlier. A few men dropping one atomic bomb at the end of the Second World War disabled well over a hundred thousand of the enemy. With atomic bombs increasing in potency and the defense remaining as powerless as it is now, the number of the prospective victims of one atomic bomb, dropped over a densely populated region, will be counted in the millions. The potentialities for mass destruction inherent in bacteriological warfare exceed even those of an improved atomic bomb in that one or a few strategically placed units of bacteriological material can easily create epidemics affecting an unlimited number of people.

However, weapons capable of destroying millions of people anywhere on earth can do no more than that and are to that extent a mere negative element in the scheme of things military and political. They may be able to break the will of the enemy to resist for the time being; but by themselves they cannot conquer and keep what has been conquered. To reap the fruits of total war and transform them into permanent political gains requires the mechanization of transport and communications.

Nowhere, indeed, has mechanical progress in the last decades been more staggering than with regard to the ease and speed of transport and communications. It can safely be said that the progress achieved in this respect during the first half of the twentieth century is greater than the progress in all of previous history. It has been remarked that the thirteen days which it took Sir Robert Peel in 1834 to hurry from Rome to London in order to be present at a cabinet meeting were exactly identical with the travel time allowed to a Roman official for the same journey seventeen centuries earlier. The best travel speed on land and sea throughout recorded history to close to the middle of the nineteenth century was ten miles an hour, a speed rarely attained on land. In the early twentieth century, railroads had increased the speed of travel by land to sixty-five miles an hour on the fastest train, six and a half times what it had been throughout history. Steamships had speeded up travel by sea to thirty-six miles an hour, three and a half times the maximum. Today the maximum speed of the airplane, at which travel might be possible under optimum conditions, is close to six hundred miles per hour, that is, ten and twenty times, respectively, more than the best travel speed about four decades ago, and sixty times more than it was a little more than a century ago.

In 1790, it took four days in the best season to go from Boston to New York, a distance somewhat exceeding two hundred miles. Today the same time is sufficient for circling the globe, regardless of season. In terms of travel speed, Moscow is today as close to New York as Philadelphia was a century and a half ago, and the whole earth is considerably smaller than was the combined territories of the Thirteen States which founded the United States of America. How rapid this development has been especially in the last few years, leaving far behind the expectations even of expert observers, is strikingly illustrated by the question which Professor Staley asked in 1939 while discussing the problems with which we are here concerned: "Is three hundred miles an hour an impossible passenger transport speed within twenty-

## *Politics among Nations*

five years?"<sup>10</sup> Only nine years later the cruising speed of the fastest passenger plane exceeds four hundred miles an hour.

The significance of mechanical progress for travel, that is, transportation of persons, is virtually identical with its significance for transportation of goods, the mechanical means in both cases being virtually identical. The only difference might be found in the even greater rapidity of the mechanical development of the land-transport of goods because of its lower starting point. While today goods can be as speedily transported as persons, with the exception of the heaviest goods at maximum speeds, before the invention of the railroad the limitations of space and of power imposed greater limitations upon the speed of the land-transport of goods than of persons. Thus the introduction of railroads in Germany before the middle of the nineteenth century increased the speed of the transportation of goods eight times, while the corresponding increase for persons was hardly more than fivefold.

The corresponding development is, however, incomparably more rapid in the field of oral and written communications. Here mechanical progress has far outstripped the one in transportation of persons and goods. Before the invention in the nineteenth century of the telegraph, the telephone, and the undersea cable, the speed of the transmission of oral or written communications was identical with the speed of travel. That is to say, the only way to transmit such communications, aside from visible signals, was by the usual means of transportation. These inventions reduced the speed needed for the transmission of such communications from what had been formerly days and weeks to hours. Radio and television have made the transmission instantaneous with the utterance.

### 5. WAR FOR TOTAL STAKES

These mechanical developments make the conquest of the world technically possible, and they make it technically possible to keep the world in that conquered state. It is true that there have been great empires before. The Macedonian Empire stretched from the Adriatic to the Indus, the Roman Empire from the British Isles to the Caucasus, and Napoleon's conquests from the borders of Gibraltar to Moscow. Yet these great empires either did not last or they lasted only because of an overwhelming differential in civilization, technical and otherwise, in favor of the ruling power as over against the subject peoples. The expansion of the Roman Empire illustrates this point. Many of its moves resemble colonial expansion into politically empty spaces rather than the overpowering of first-rank competitors. The other empires, however, could not last and fell far short of conquering all of the known political world because they were lacking in those technological resources necessary for the subjugation and permanent control of great masses of people dispersed over wide expanses of territory.

The technological prerequisites for a stable world-wide empire are essentially three in number: (1) enforced social integration through central-

<sup>10</sup> Eugene Staley, *World Economy in Transition* (New York: Council on Foreign Relations, 1939), p. 13.

ized control over the minds of the subjects of the empire, (2) superior organized force at any point of possible disintegration within the empire, and (3) permanency and ubiquity of these means of control and enforcement throughout the empire. None of these three military and political prerequisites has been achieved in the past, yet they are within the reach of our time.

Then the means of communication were nonmechanical or, where mechanical, they were strictly individualized and, hence, decentralized. News and ideas could be transmitted only by word of mouth, by letters, or through the printing press which one individual could operate in his home. In this field, then, the would-be conqueror of the world had to compete on an approximately equal footing with an unlimited number of rivals. He could put his rivals into prison or condemn them to death if he was able to identify and apprehend them. But he could not smother their voices through a monopoly or near-monopoly of the collection and dissemination of news, of press, radio, and moving picture. Nineteen centuries ago, St. Paul could go from city to city and write letters to the Corinthians and Romans, spreading the gospel, which was about all that the representatives of the religion of the Roman Empire could do, and when he was executed he left thousands of disciples doing what he had done in ever more effective and widespread competition with the representatives of the state. What could St. Paul do in the world empire of tomorrow without a newspaper or magazine to print his messages, without a radio network to carry his sermons, without newsreel and television to keep his likeness before the public, probably without a post office to transmit his letters, and certainly without a permit to cross state lines?

The means of violence, as we have already pointed out, were in former times largely nonmechanical and always individualized and decentralized. Here, too, the would-be founder of a world empire met his future subjects, barring superior organization and training, on a footing of approximate equality. Either side had virtually the same weapons with which to cut, to thrust, and to shoot. The conqueror, in order to maintain his empire, would have had to achieve the impossible by establishing everywhere actual superiority of organized force against all possible opponents. Thus the inhabitants of Madrid could on May 3, 1808, raise against the French conqueror the same arms which the latter had at his disposal and drive him from the city. Today the government of a world empire, appraised of a similar situation by radio, would send within a few hours a squadron of bombers and a score of transports loaded with parachutists, mortars, and tanks, weapons of which it has a monopoly or near-monopoly, to the revolting city and squelch the revolt with ease. The very threat of the intervention of such overwhelming force, ready to strike at any place at a moment's notice, would discourage the mere thought of revolt.

Finally, the mechanization of communications has relieved the would-be founder of a world empire from that dependency upon favorable climate and geographical location which proved the undoing of Napoleon and prevented less dynamic and less tempted leaders from even conceiving the idea of world conquest. The one great impediment to world conquest in this respect was the necessity, lasting well into the nineteenth century, to stop fighting during the late fall, winter, and early spring; for it was impossible to protect the

## *Politics among Nations*

army in the field against the weather and supply it with the necessities of life and the implements of war. Thus the enemy, if he was not overpowered beyond the hope of recovery in one campaign, was given a chance to prepare himself for a new campaign in the next fighting season. War, then, resembled a boxing match in which the intermissions after each round were long enough virtually to assure the comeback of the weaker opponent provided he was not knocked unconscious. Under such circumstances, to think of world conquest would have been sheer folly, for the work of conquest done in one fighting season had to be largely redone in the next. Since victory was less the result of conquest and annihilation than of the comparatively greater exhaustion of the vanquished, even the victor would have been far from possessing the resources necessary to take on new enemies every spring until he had conquered the world.

Yet, even if he had been brazen enough to start on the road to world conquest, he could not have gone far. Incapable of maintaining actual superiority of armed strength throughout the conquered territories, he would have been constantly faced with the likelihood of revolts prepared and executed without his being able to meet them in time. The slowness of communications and the technical difficulties of transportation would have made it impossible for the would-be conqueror of the world to consolidate whatever permanent conquests he might have been able to make. The further he extended the limits of his empire the greater would be the probability of his downfall. When Napoleon's empire had reached the zenith of its power in 1812, it was also closer than ever before to its disintegration. For while Napoleon was fighting at the fringes of his domain, pushing them ever farther away from the French sources of his power, the victims of his conquest could prepare behind his back for liberation. When they struck, aided by the largely uncommitted and unconquered resources of Great Britain and Russia, the main bulk of Napoleon's forces was far away and had to be brought back to the scene of revolt in defiance of the winter season and with tremendous losses, to be beaten at the spot which not the conqueror, but the conquered, had chosen.

Today the prospective conqueror of the world has technical means at his disposal for stabilizing beyond recall gains once made; for within the conquered territory the superiority of organized force, of which we have spoken above, is at his disposal everywhere and at all times, regardless of season and distance. An incipient revolt occurring a thousand miles from the next concentration of his air forces takes place in a distance of about twenty miles in terms of the Napoleonic technology of transportation and happens just around the corner in terms of the Napoleonic technology of communications. In other words, the conqueror is in a position to put all the modern techniques of mass propaganda into operation almost instantaneously in order to dissuade the disaffected from their undertaking. Within the span of a few hours, he can bring his superiority in organized force to bear upon the revolutionaries.<sup>11</sup>

---

<sup>11</sup> The failure of the plot against Hitler in 1944 well illustrates this enormous superiority of the government in the face of an attempted revolt, even if staged by part of the armed forces. It shows, in particular, the decisive importance of modern mass communications controlled by the government; for it was for all practical purposes the voice of Hitler, speaking over the radio

Thus a conquest once made is made for good, from the point of view of the technological possibilities and barring, of course, blunders by the government, outside help from a superior force, or political and military contingencies from within the empire. With these qualifications, a people once conquered will stay conquered, for it has no longer the means to revolt, and the chances are that the conqueror, through his monopolistic control of the means of communications, will have deprived it of the will to revolt as well. For as Edmund Burke has said: "Let us only suffer any person to tell us his story, morning and evening, but for one twelve-month, and he will become our master."<sup>12</sup>

Today no technological obstacle stands in the way of a world-wide empire provided the ruling nation is able to keep its superiority in the technological means of domination. A nation which has a monopoly of atomic energy and of the principal means of transport and communications can conquer the world and keep it conquered, provided it is capable of keeping that monopoly and control. First of all, it will be able to mold the minds of the citizens of its world empire into a uniformity of submissiveness, of which the totalitarian societies of the recent past and present have given us fair samples. Under the assumption of a reasonably effective government, the will to revolt will at best be scattered and in any case it will lack political and military significance. Second, any attempt at revolt will meet with the speedy reaction of superior power and is thus doomed to failure from the outset. Finally, modern technology makes it possible to extend the control of mind and action to every corner of the globe regardless of geography and season.

## 6. TOTAL MECHANIZATION, TOTAL WAR, AND TOTAL DOMINION

This analysis of the mechanization of modern war and of its military and political implications would not be complete if it did not consider the over-all mechanization of Western culture, of which the mechanization of warfare is but a particular manifestation. For without that over-all mechanization the modern nations would never have been able to put mass armies into the field and keep them supplied with provisions and arms. Total war presupposes total mechanization, and war can be total only to the degree to which the mechanization of nations waging it is total.

From the beginning of history to the American Civil War and the Franco-Prussian War of 1870, all military movements were executed by muscular power. Men would carry themselves and the implements of war either with their own muscles or with those of animals. All military movements as well as the size and quality of arms and armies were limited by the natural quan-

---

to the people and to some of the leaders of the revolt, which decided the issue in favor of the government. Cf. the excellent account in Allen W. Dulles, *Germany's Underground* (New York: The Macmillan Company, 1947).

<sup>12</sup> "Thoughts on French Affairs," *Works* (Boston: Little, Brown, and Company, 1889), IV, 328.



## *Politics among Nations*

tity and quality of the available muscular power of men and beasts. It was the German Army which in 1870 for the first time used railroads systematically, after they had been used during the Civil War sporadically, as a means of transportation. The Germans thus gained a considerable strategic and tactical advantage over the French. Yet, as late as 1899, during the Boer War, as many as thirty-two oxen were used for drawing one five-inch gun. The slowness of the movement, the natural limitations of numbers which no human effort could overcome, and the requirements for the procurement and the transport of fodder made a war thus waged slow and cumbersome. It was the energy supplied not by muscle, but by coal, water, and oil, in the form of the steam engine, the turbine, the electric motor, and the internal combustion engine, which multiplied by many times the productivity of men in peace and war. Professor James Fairgrieve, speaking primarily of Great Britain, vividly describes the contribution of coal to this development:

Then into this world of agriculture and pasture and little market towns with a few ports and governmental cities there came, a little more than a century and a half ago, the beginnings of the Industrial Revolution. Coal, which up till then had been used here and there merely for domestic purposes, came to be used to drive machines which would do far more work than the individual man or animal, or even a number of men or animals could do. Man harnessed energy outside himself to do the things which before then he had to do himself with his own hands. Here was a tremendous new store of energy, not food energy at all, by which things could be done which could not be done before. Man has been able to use energy on a far vaster scale. . . . A man's clothing is prepared for him to the last stitch, so that there is very little clothes-making in the home. His food is to a very great extent made ready for his table, with the result that even in his home there is far less preparation of it, and in great cities food preparation on a large scale is such an industry that he may at almost any hour of the day or night obtain such a meal as suits his pocket or his palate. . . .

It has been calculated that the coal used in our factories alone, all other uses whatsoever being excluded, gives the equivalent of the energy of 175,000,000 hard-working men, and in such a useful form as men could never supply. The power of Greece, whereby she achieved such great things in all directions of human progress, was largely based in the first instance on the work done by the servile class. On the average each Greek freeman, each Greek family, had five helots whom we think of not at all when we speak of the Greeks, and yet these were the men who supplied a great part of Greek energy. In Britain, we may say, every family has more than twenty helots to supply energy, requiring no food and feeling nothing of the wear and tear and hopelessness of a servile life. With a population of 45 million men, women and children, Britain's factories are worked by 175 million man-power more. In comparison with the energy supplied to machines in which things are made to move by purely mechanical means, the physical energy supplied by the fewer than 20 million men and women scarcely counts. We have become a nation of engineers, pressing buttons and pulling levers, oiling and packing, so that the great social machine will work smoothly and as easily as possible. The inanimate helots grind our corn, make our clothes, fetch our food from the ends of the earth, carry us hither and thither to work and play, print our news and our books of wisdom, and perform numberless services of which the Greeks never dreamed. . . .

There are fifty inanimate slaves of the furnace for every man, woman and child in the United States. . . .<sup>13</sup>

The savings in labor by virtue of this mechanization are enormous. To quote Professor Fairgrieve again, "Between 1855 and 1894 the time of human labour required to produce one bushel of Indian corn on an average was reduced from four and a half hours to under three-quarters of an hour. Between 1830 and 1896 the time of human labour required to produce a bushel of wheat was reduced from three hours to ten minutes."<sup>14</sup> American farm production in 1944 was the largest in history, while in the same year the number of people employed in agriculture was the lowest for seventy years. While in technologically backward countries up to 90 per cent of the population is engaged in agriculture, the percentage of the total population working in agriculture in the United States declined from 50 per cent in 1870 to less than 20 per cent in 1940. While in 1910 more than 30 per cent of the population of the United States was engaged in farming, producing 20 per cent of the national income, the corresponding figures were 20 per cent of the population and somewhat more than 7 per cent of the national income in 1940, 15 per cent of the population and 10 per cent of the national income in 1946.

Professor Hornell Hart reports the following examples illustrating the same trend in industry:

Until 1730 spinning, for example, was all done by hand: the spinner slowly and laboriously drew out one strand at a time. During the past 200 years machinery has so revolutionized the process that one operative takes care of 125 spindles, all turning at a speed of 10,000 revolutions per minute. In the Philippines, where industry is still in the ancient man-power stage, a cargo of copra is loaded by 200 to 300 coolies; in San Francisco, with its Machine-Age economy, 16 men unload the ship in one quarter of the time required to load it. The efficiency of the men working with power-machinery is fifty times that of the man-power loaders. One steam shovel does the work of 200 unskilled men; a glass blowing machine takes the place of 600 skilled workers; one automatic electric bulb machine produces as much as 2000 workers could formerly.<sup>15</sup>

A number of industrial processes have virtually eliminated human labor altogether. This is true particularly in the production of hydroelectric power which takes place without the presence of a single worker and is controlled by automatic electric signals. The production of pulp paper is entirely automatic from the feeding of the fluid pulp into the machinery to the emergence of the rolled paper. The same is true of the printing of newspapers from the feeding of the empty pulp into the machine to the emergence of the folded end-product. The manufacture of rayon and silk, of steel and automobiles, the production and canning of food, especially the processing of flour, have been mechanized with similar effects upon the increase in productivity and the displacement of muscular labor. While, owing to the small degree of mechaniza-

<sup>13</sup> *Geography and World Power* (8th ed.; London: University of London Press, Ltd., 1941), pp. 314-17, 326. (Reprinted by permission of the publisher.)

<sup>14</sup> *Ibid.*, pp. 323-4.

<sup>15</sup> *The Technique of Social Progress* (New York: Henry Holt and Company, 1931), p. 134. (Reprinted by permission of the publisher.)

## *Politics among Nations*

tion in many productive processes, the over-all results of mechanization are considerably less impressive than these most spectacular examples would indicate, the trend is so general and so radical in some of the most important fields of production as to amount to a revolution — the greatest in recorded history — of the productive processes of mankind.

It is this revolution in the productive processes of the modern age which has made total war and world-wide dominion possible. Before its advent war was bound to be limited in its technological aspects. The productivity of a nation was not sufficient to feed, clothe, and house its members and to keep large armies supplied with the implements of war for any length of time. More particularly, national economies operated on so narrow a margin above the mere subsistence level that it was impossible to increase to any appreciable extent the share of the armed forces in the national product without endangering the very existence of the nation. In the seventeenth and eighteenth centuries, it was not at all unusual for a government to spend as much as, or more than, two-thirds of the national budget for military purposes. A few times during that period military expenses consumed more than 90 per cent of the total outlay of the government. Military expenditures had, of course, precedence over all others, and the national product was too small to be taxed extensively for other purposes. Thus it was not by accident that before the nineteenth century all attempts at universal military service failed, for in the interest of keeping national production going, the productive classes of the population had to be exempt from military service. Only the scum which was unable to engage in productive enterprises and the nobility which was unwilling to engage in them could safely be conscripted.

The Industrial Revolution and, more particularly, the mechanization of agricultural and industrial processes in the twentieth century have had a triple effect upon the character of war and of international politics. They have increased the total productivity of the great industrial nations enormously. They have, furthermore, reduced drastically the relative share of human labor in the productive processes. They have, finally, together with the new techniques in medicine and hygiene, brought about an unprecedented increase in the populations of all nations. The increase in productivity thus achieved exceeds by far the increased demands upon the national product caused by the higher standard of living and the greater number of consumers. Excess in productivity is now available for new purposes and it can be guided into the channels of total war. The new energy created by the machine and much of the human energy which a century and a half ago was still absorbed in the business of keeping alive can now be employed for military purposes, either directly by way of military service or indirectly through industrial production.

The human energy now available for war is not muscular energy only. The machine age has lightened immensely the intellectual and moral burden of keeping one's self and one's dependents fed, clothed, and protected from the elements and from disease, which a century and a half ago still absorbed most of the vital energies of most men. Moreover, it has provided most men with an amount of leisure which only few men have ever had before. Yet, paradoxically enough, by doing so it has freed tremendous intellectual and moral energies which have gone into the building of a better world, but which have

also gone into the preparation and the waging of total war. This concatenation of human and material forces, freed and created by the age of the machine, has given war its total character.<sup>16</sup>

It has also given total war that terrifying, world-embracing impetus which seems to be satisfied with nothing short of world dominion. With his intellectual and moral energies no longer primarily concerned about this life nor any more able to be deflected toward concern with the life thereafter, modern man looks for conquests, conquest of nature and conquest of other men. The age of the machine, which has sprung from man's self-sufficient mind, has instilled in modern man the confidence that he can save himself by his own unaided efforts here and now. Thus the traditional religions with their negation of that confidence and their reliance upon divine intervention have become bloodless images of themselves. The intellectual and moral lifeblood of modern man streams into the political religions which promise salvation through science, revolution, or the holy war of nationalism. The machine age begets its own triumphs, each forward step calling forth two more on the road of technological progress. It also begets its own victories, military and political; for with the ability to conquer the world and keep it conquered, it creates the will to conquer it.

Yet it may also beget its own destruction. Total war waged by total populations for total stakes under the conditions of the contemporary balance of power may end in world dominion or in world destruction or in both. For either one of the two contenders for world dominion may conquer with relatively small losses to itself; or they may destroy each other, neither being able to conquer; or the least weakened may conquer, presiding over universal devastation. Such are the prospects which overshadow world politics as we approach the half-way mark of the twentieth century.

Thus we have gone full circle. We recognized the driving element of contemporary world politics in the new moral force of nationalistic universalism. We found a simplified balance of power, operating between two inflexible blocs, to be the harbinger of great good or great evil. We discovered the menace of evil in the potentialities of total war. Yet the element which makes total war possible—the mechanization of modern life—makes possible also the moral force which, through the instrumentality of total war, aims at total dominion.

---

<sup>16</sup> In the words of Professor Nef: "Once the nations found issues which they were prepared to quarrel over, which it was possible to persuade the ordinary man to die for, there was no longer anything inherent in material conditions, to hold them back, or to chain the passions of their leaders." "Limited Warfare and the Progress of European Civilization, 1640-1740," *The Review of Politics*, VI (July, 1944), 314.

*PART EIGHT*

THE PROBLEM OF PEACE IN  
THE MID-TWENTIETH CENTURY:  
PEACE THROUGH LIMITATION



## CHAPTER XXI

### *Disarmament*

#### I. THE PROBLEM OF PEACE IN OUR TIME

Two world wars within a generation and the potentialities of mechanized warfare have made the establishment of international order and the preservation of international peace the paramount concern of Western civilization. War has always been abhorred as a scourge. As the rise of the territorial state transformed the Holy Roman Empire from the actual political organization of Christendom into an empty shell and a legal fiction, writers and statesmen reflected more and more on substitutes for the lost political unity of the Western World. Erasmus in the sixteenth century, Sully, Éméric Crucé, Hugo Grotius, and William Penn in the seventeenth, the Abbé de Saint-Pierre, Rousseau, Bentham, and Kant in the eighteenth were the great intellectual forerunners of the practical attempts to solve the problems of international order and international peace, which were undertaken in the nineteenth and twentieth centuries.

Of these attempts, the Holy Alliance, the Hague Peace Conferences of 1899 and 1907, the League of Nations, and the United Nations are the outstanding examples. These organizations and conferences, together with other less spectacular endeavors to shape a peaceful world, were made possible by four factors — spiritual, moral, intellectual, and political — which started to converge at the beginning of the nineteenth century and culminated in the theory and practice of international affairs prevalent in the period between the two world wars.

Since the time of the Stoics and the early Christians, there has been alive in Western civilization a feeling for the moral unity of mankind which strives to find a political organization commensurate with it. The Roman Empire was such a political organization of universal scope. After its downfall, the Roman Empire remained throughout the ages a symbolic reminder of the unity of the Western World and the ultimate goal and standard which inspired Charlemagne no less than Napoleon and determined the policies of the Holy Roman Empire until the beginning of the religious wars. It is not by accident that the dissolution of the Holy Roman Empire in 1801 coincided with Napoleon's attempt to revive it and antedates by little more than a decade the beginning of that period of modern history which has made the restoration of international order one of its major objectives.

The moral root of these attempts to establish a stable and peaceful international order is to be found in the increase in the humaneness and civilized

## *Politics among Nations*

character of human relations which the last centuries have witnessed in the Western World. The philosophy of the Enlightenment and the political theory of liberalism postulated respect for human life and the promotion of human welfare. The great political and social reforms of the nineteenth and twentieth centuries drew their inspiration from these postulates. To extend the reign of law, peace, and order to the international sphere was then the great humanitarian task which the modern age had to solve.

The intellectual factor promoting this development is connected with the rise of the commercial classes first to social and then to political importance. With them rose to prominence the commercial and scientific spirit which dreaded war and international anarchy as irrational disturbances of the calculable operations of the market. "A war in the midst of different trading nations," Diderot noticed, "is a fire disadvantageous to all. It is a process which threatens the fortune of a great merchant and makes his debtors turn pale."<sup>1</sup> According to Kant, "the commercial spirit cannot co-exist with war."<sup>2</sup> Thus, toward the end of the eighteenth century, it had become the conviction of many that war was obsolete or in any case an atavism which a concerted rational effort of humanity could banish from the earth with relative ease.

It was, however, the cataclysm of the Napoleonic Wars which demonstrated the need for supplementing the theoretical quest for the solution of the problem of international order and peace with practical measures. The importance of the Napoleonic Wars in this respect is twofold. They destroyed the balance of power and threatened temporarily to replace it with a universal empire. While this factor passed with the definitive defeat of Napoleon in 1815, the other element has threatened the stability of the modern state system for a century and a half and has not yet spent its force. This other element is nationalism. The idea of nationalism, evoked by the French Revolution and carried by the Napoleonic conquests through Europe, challenged the principle of dynastic legitimacy which had been the organizing principle of the modern state system and was still the foundation of the peace settlements of 1815.

The convergence of these four experiences at the beginning of the nineteenth century and their dynamic release into the political arena through the shock of the Napoleonic Wars provided the intellectual and moral energy which has sustained for the last century and a half the search for alternatives to war and international anarchy. This search, in so far as it has left the realm of mere ideas, hopes, and admonitions and has materialized in actual measures and institutions of an international character (it is with the latter that we are here alone concerned), has been carried on through three different media: (1) limitation of the destructive and anarchical tendencies of international politics, (2) transformation of international politics by eliminating its destructive and anarchical tendencies altogether, and (3) accommodation of divergent interests by depriving the destructive and anarchical tendencies of international politics of their rational objectives.

Of the attempts to achieve peace through limitation the one which calls first for our attention is that of disarmament.

<sup>1</sup> "Fragments politiques," *Œuvres complètes* (Paris: Garnier Frères, 1875), IV, 42.

<sup>2</sup> *Perpetual Peace* (New York: The Macmillan Company, 1917), p. 157.



## 2. HISTORY OF DISARMAMENT

Disarmament is the reduction or elimination of certain or all armaments for the purpose of eliminating the armaments race. By doing away with one of the typical manifestations of the struggle for power on the international scene, it is believed that one can do away with the typical effects of that struggle: international anarchy and war.

Two basic distinctions must be kept in mind: the distinction between general and local disarmament, and the distinction between quantitative and qualitative disarmament. When we speak of general disarmament, we refer to a kind of disarmament in which all the nations concerned participate. Examples are the Washington Treaty for the Limitation of Naval Armaments of 1922, signed by all major naval powers, and the World Disarmament Conference of 1932, at which practically all members of the community of nations were represented. We speak of local disarmament when only a limited number of nations are involved. The Rush-Bagot Agreement of 1817 between the United States and Canada is an example of this type. Quantitative disarmament aims at an over-all reduction of armaments of most or all types. This was the goal of most nations represented at the World Disarmament Conference of 1932. Qualitative disarmament envisages the reduction or abolition only of certain special types of armaments, such as the aggressive weapons which Great Britain tried to have outlawed by the World Disarmament Conference of 1932, or atomic weapons, the suppression of which has been under discussion by the Atomic Energy Commission of the United Nations.

The history of the attempts at disarmament is a story of many failures and few successes. Both failures and successes point up the fundamental problems raised by disarmament as a device to insure international order and peace.

The first practical step in favor of disarmament as a measure of general pacification<sup>3</sup> coincides with the beginning of that period of international relations in which statesmen to an ever increasing extent have dedicated their efforts to the establishment of international peace and order. In 1816, the Czar of Russia proposed to the British government the "simultaneous reduction of the armed forces of every kind." The British monarch replied by suggesting the implementation of the Russian proposal in the form of an international conference where the military representatives of all powers should determine the respective strength of the armies of each power. Austria and France expressed their sympathies with the proposal, which, however, was not seriously considered by any of the governments and thus remained without any practical results. In 1831, the French government made similar proposals to the representatives of the great powers. These proposals found a favorable reception, but nothing more was heard of them. The same must be said of the proposals which Napoleon III made in 1863, 1867, and 1869 for a general reduction of armaments. In 1870, immediately before the outbreak of the Franco-German War, Great Britain, on the instigation of France, twice approached the Prussian government on the question of the reduction

<sup>3</sup> There were a few steps toward local disarmament in the eighteenth century.

## *Politics among Nations*

of armaments, but without success. Another such approach, this time undertaken by Italy in 1877, was similarly rejected by Germany.

The First Hague Peace Conference of 1899 had as one of its main purposes the limitation of armaments and of military budgets. It was attended by the representatives of twenty-eight nations, among them all the major powers. The results of the deliberations of the Conference with regard to disarmament are embodied in two resolutions which speak for themselves. The committee in which these deliberations took place declared that it was "of opinion that the restriction of military charges, which are at present a heavy burden on the world, is extremely desirable for the increase of the material and moral welfare of mankind."<sup>4</sup> The full Conference, in adopting this resolution, expressed "the wish that the governments taking into consideration the proposals made at the Conference may examine the possibility of an agreement as to the limitation of armed forces by land and sea, and of war budgets."

The Second Hague Peace Conference of 1907, attended by forty-four nations, confirmed "the resolution adopted by the Conference of 1899 in regard to the limitation of military expenditure; and inasmuch as military expenditure has considerably increased in almost every country since that time, the Conference declares that it is eminently desirable that the governments should resume the serious examination of this question."<sup>5</sup> The President of the Conference, the Russian delegate, summed up the efforts of both Conferences with regard to disarmament by thus commenting on this resolution: "If the question was not ripe in 1899, it is not any more so in 1907. It has not been possible to do anything on these lines, and the Conference today finds itself as little prepared to enter upon them as in 1899."<sup>6</sup>

The Treaty of Versailles took another step toward disarmament as a means of general pacification by stipulating a drastic limitation of German armaments "in order to render possible the initiation of a general limitation of the armaments of all nations."<sup>7</sup> Article 8 of the Covenant of the League of Nations more specifically declared "that the maintenance of peace requires the reduction of national armaments to the lowest point consistent with national safety and the enforcement by common action of international obligations." It charged the Council of the League of Nations with the formulation of plans for such reduction. In pursuance of these stipulations, the Council established in 1925 a Preparatory Commission for a Disarmament Conference. Its tentative and incomplete conclusions were submitted to a World Disarmament Conference which convened at Geneva in 1932. With the withdrawal of Germany in October 1933, the Conference became moribund. Its general commission met for the last time in 1934. The World Disarmament Conference was an unmitigated failure, unable to reach formal agreements of any kind.

These efforts at general disarmament were interrupted by the Second World War. The Charter of the United Nations took up where the Covenant

---

<sup>4</sup> James Brown Scott, *The Proceedings of The Hague Peace Conference. The Conference of 1899* (New York: Oxford University Press, 1920), p. 390.

<sup>5</sup> *Loc. cit.*, The Conference of 1907, I, 89, 90.

<sup>6</sup> *Ibid.*, p. 92.

<sup>7</sup> Introduction to Part V of the Treaty of Versailles.

of the League of Nations had left off. According to Article 11, paragraph 1, of the Charter, "The General Assembly may consider the general principles of cooperation in the maintenance of international peace and security, including the principles governing disarmament and the regulation of armaments, and may make recommendations with regard to such principles to the Members or to the Security Council or to both." Article 26 of the Charter provides that "in order to promote the establishment and maintenance of international peace and security with the least diversion for armaments of the world's human and economic resources, the Security Council shall be responsible for formulating . . . plans to be submitted to the Members of the United Nations for the establishment of a system for the regulation of armaments."

In pursuance of these provisions of the Charter, the Assembly created through its resolution of January 24, 1946, an Atomic Energy Commission for the purpose of making specific proposals "for control of atomic energy to the extent necessary to insure its use only for peaceful purposes; for the elimination from national armaments of atomic weapons and of all other major weapons adaptable to mass destruction."<sup>8</sup> With regard to so-called "conventional" armaments, the Assembly passed on December 14, 1946, a resolution on "Principles Governing the General Regulation and Reduction of Armaments."<sup>9</sup> In it the Assembly recognized "the necessity of an early general regulation and reduction of armaments and armed forces" and called upon the Security Council to consider promptly the practical means necessary to that effect. Consequently, on February 13, 1947, the Security Council passed a resolution establishing a Commission for Conventional Armaments. The purpose of this Commission is the preparation of "proposals (a) for the general regulation and reduction of armaments and armed forces, and (b) for practical and effective safeguards in connection with the general regulation and reduction of armaments."<sup>10</sup> Thus far neither the Commission for Conventional Armaments nor the Atomic Energy Commission have succeeded in reaching agreement of any kind on the substantive problems before them.

The only successful disarmament provisions of the nineteenth century are found in the Rush-Bagot Agreement concluded in 1817 between the United States and Canada. It limits the naval forces on the Great Lakes to three vessels of equal tonnage and armament for each nation. Revised early in the Second World War in order to allow Canada to construct vessels on the Great Lakes for use against the Axis, it has remained in force to this day.

The outstanding example of a venture in disarmament compounded of success and failure is the Washington Treaty for the Limitation of Naval Armaments of 1922. This Treaty established approximate equality in capital ships between the United States and the British Empire, with the strength of Japan, France, and Italy trailing the English-speaking countries in this order. In consequence, the British Empire, the United States, and Japan scrapped about 40 per cent of their strength in capital ships. Furthermore, it was stipulated that replacements, to begin in 1931, should establish by 1942 a 5:5:3:

---

<sup>8</sup> Resolution of the General Assembly, *Atomic Energy Commission Official Records, Supplement No. 1*; also *U. N. doc. A/64*, p. 9.

<sup>9</sup> *Journal of the United Nations*, No. 75, Supp. A-64, add. 1, p. 827.

<sup>10</sup> *U. N. doc. S/P.V.*, 105.

## *Politics among Nations*

1.67:1.67 ratio for the capital ships of the British Empire, the United States, Japan, France, and Italy. The Washington Conference, however, failed to produce agreement with regard to any naval craft other than capital ships, such as cruisers, destroyers, and submarines.

The Geneva Naval Conference of 1927, attended only by Great Britain, Japan, and the United States, likewise failed to reach agreement on this issue. Finally, at the London Naval Conference of 1930, the United States, Great Britain, and Japan agreed upon parity between the United States and Great Britain for cruisers, destroyers, and submarines, with Japan limited to approximately two-thirds of the American and British strength in these categories. France and Italy did not accede to the Treaty, since Italy demanded parity with France, which France refused to concede.

In December 1934, Japan served formal notice of its intention to terminate the Washington Treaty of 1922. It submitted to the London Naval Conference of 1935-36 a demand for parity in all categories of naval armament. This demand was rejected by the United States and Great Britain. In consequence Japan retook its freedom of action. The only result of the Conference which had any bearing upon the size of naval armaments was an agreement among the United States, Great Britain, and France, adhered to by Germany and the Soviet Union in 1937, which limited the maximum size of naval vessels, provided that no other nation exceeded that maximum. A separate Anglo-German agreement, concluded in 1935, limited German total naval strength to 35 per cent of the British and allowed Germany a strength in submarines equal to that of the British Empire, provided that the total submarine tonnage of Germany remained within the 35 per cent limit.

### 3. FOUR PROBLEMS OF DISARMAMENT

( This record, long in failures and short in successes, raises four fundamental questions. Success or failure of any particular attempt at disarmament depend upon the answers which can be given to these questions:

- (a) What is the ratio among the armaments of different nations to be?
- (b) What is the standard according to which, within this ratio, different types and quantities of armaments are to be allocated to different nations?
- (c) Once these two questions have been answered, what is the actual effect of the answers in view of the intended reduction of armaments?
- (d) What is the bearing of disarmament upon the issues of international order and peace?

#### *a) The Ratio*

( Armaments and the armaments race are a manifestation — and one of the most important manifestations — of the struggle for power on the international scene. From this fundamental fact all the technical arguments, proposals, counterproposals, and disagreements with regard to disarmament receive their significance. Nations arm because they want either to defend themselves against other nations or because they want to attack them. All

politically active nations are by definition engaged in a competition for power of which armaments are an indispensable element. Thus all politically active nations must be intent upon acquiring as much power as they can, that is, among other things, upon being as well armed as they can. Nation A which feels inferior in armaments to nation B must seek to become at least the equal of B and if possible to surpass B. On the other hand, nation B must seek at least to keep its advantage over A if not to increase it. Such are, as we have seen,<sup>11</sup> the inevitable effects of the balance of power in the field of armaments.)

What is at stake in the armaments race between A and B is the ratio of the armaments of both nations. Shall A and B be equal in armaments, or shall A be superior to B, or vice versa, and if so, to what extent? This question is necessarily first on the agenda of disarmament commissions and conferences. It can find a satisfactory answer only under three alternative conditions: (a) the nations concerned do not engage in competition for power with other nations; (b) a nation or group of nations have such a preponderance over another nation or group of nations that they are able to impose upon the latter a ratio favorable to themselves; (c) two or more nations find it advantageous for the time being to engage in regulated rather than free competition for power and to enter into an armaments race within agreed-upon limits rather than into a wild scramble for increases in military strength.)

It is obvious that these alternatives are likely to materialize only under the conditions of local disarmament. For only under such conditions is the competition for power likely either to be eliminated altogether or to be transformed into a regulated, relatively stable pattern which is reflected in the ratio of armaments. The few successful ventures into disarmament have actually all been of the local kind.)

THE RUSH-BAGOT AGREEMENT, THE WASHINGTON TREATY, AND THE ANGLO-GERMAN NAVAL AGREEMENT. The classic example of pattern (a) is the Rush-Bagot Agreement between the United States and Canada. In the relations of the two countries there is virtually no chance for a competition for power which might transform itself into an armed quest for each other's territory. This absence of the possibility of armed conflict has made the thirty-eight hundred miles of Canadian-American frontier the longest unarmed frontier of the world. It also constitutes the political precondition for the permanent success of naval disarmament on the Great Lakes.

The Washington Treaty of 1922 provides an example of pattern (a) with respect to the relations between the United States and Great Britain, and an example of pattern (b) with regard to the relations between the United States and Great Britain, on the one hand, and Japan, on the other.

The United States sought parity with Great Britain in battleship strength. It was bound to achieve that parity because of its superior and militarily uncommitted industrial resources. The only question was whether it would achieve parity by way of bitter and costly competition or by way of mutual agreement. Since there was no political conflict between the two countries which would have justified such competition, the two countries agreed upon a practically identical maximum tonnage for the battleships of both.

<sup>11</sup> See above, pp. 136, 137.

## *Politics among Nations*

Furthermore, the First World War had made Japan the preponderant naval power in the Far East, thus threatening the interests of the United States and Great Britain in that region and inviting them to a naval armaments race. Such a race, however, the United States, for financial and psychological reasons, was anxious to avoid. Great Britain, on the other hand, was tied to Japan by a military alliance. More particularly, the British dominions dreaded the possibility of finding themselves on the Japanese side in the event of a conflict between Japan and the United States. Thus Great Britain and the United States not only were not separated by political conflicts which might lead to war; they had also an identical interest in avoiding an armaments race with Japan. By dissolving the alliance with Japan and agreeing to parity with the United States on a level it could afford, Great Britain solved its politico-military problems in the field of naval armaments. By separating Great Britain from Japan and reaching parity with Great Britain cheaply, the United States, too, obtained what it wanted in that field.

This understanding between the United States and Great Britain not only isolated Japan but placed it at the same time in a position of hopeless inferiority with regard to heavy naval armaments. Instead of embarking upon a ruinous armaments race which it had no chance of winning, Japan made the best of an unfavorable and humiliating situation: it accepted its status of inferiority for the time being and agreed upon stabilizing this inferiority at the ratio mentioned above. When the Anglo-American reaction to Japan's invasion of China at the beginning of the thirties showed that the united front of Great Britain and the United States with regard to the Far East, which had made the Washington Treaty of 1922 possible, no longer existed, Japan at once freed itself from the shackles of that treaty. As far as the Japanese position vis-à-vis the Anglo-American naval supremacy was concerned, the disarmament provisions of the Washington Treaty were the product of a peculiar political situation. These provisions could not survive the political conditions which had created them.

Of pattern (c) the Anglo-German Naval Agreement of 1935 is a typical instance. At that time the breakdown of the World Disarmament Conference and the policies of the German government demonstrated the unshakable resolve of the latter to rearm in order to attain what it called "equality" with the other major military powers. In relation to Great Britain rearmament could only mean sufficient strength in smaller craft to meet British superiority in capital ships. On the other hand, the British government was as firmly resolved not to engage in policies which were calculated to maintain the status quo with regard to Germany's naval armaments. For such policies would involve the risk of war or at least of an uncontrolled armaments race with Germany and would in any case strengthen French and Russian influence in Europe at the expense of Germany. In such circumstances the question before the British government was not how to prevent the naval rearmament of Germany, but how to preserve British naval supremacy in the face of it, without imposing upon Great Britain an expensive rearmament program.

The Anglo-German Naval Agreement of 1935 was the codification of these complementary interests of Great Britain and Germany. Great Britain held

## *Disarmament*

German naval strength, in terms of tonnage, at a safe distance. In case of need it could even have increased that distance by increasing its own tonnage to such an extent and at such speed as to make it impossible for Germany with its belated start and committed resources ever to reach the agreed-upon maximum of 35 per cent of the British tonnage. Germany received the recognition of its right to rearm within limits which, in view of its resources and other military commitments, it would in no event have been able to exceed in the immediate future. More particularly, the agreement gave Germany parity in submarines, the one naval weapon which, in view of its strategic position, was the natural means of attack and defense against a navy whose superiority in over-all tonnage and battleship strength was beyond challenge. In the spring of 1939, it had become unmistakably clear that Great Britain and Germany had entered upon an out-and-out armaments race in preparation for an inevitably approaching war. It was only in keeping with this change in the political situation that Germany, in April 1939, denounced the Agreement of 1935 and resumed in law the freedom of action which its political objectives had already compelled it to resume in fact.

It will be noted that in all these cases disarmament was agreed upon by two nations or a limited number of nations and was, therefore, of a local character. It will also be noted that the agreed-upon ratio reflected either the absence of competition for power, or the preponderance, unchallengeable for the time being, of one or more nations over another, or a temporary preference on either side for regulated rather than unregulated competition for power in the form of competition for armaments.

What, then, are the chances for agreement upon a ratio of armaments to be reached when most or all the major powers are seeking general disarmament, while at the same time pursuing their contests for power? To put it bluntly, the chances are nil. All attempts at general disarmament, such as the two Hague Conferences, the Geneva Conference of 1932, the two disarmament commissions of the United Nations, as well as most of the local undertakings of the last century and a half, have not failed primarily because of shortcomings in preparation and personnel or of bad luck. They could not have succeeded even under the most favorable circumstances; for the continuation of the contest for power among the nations concerned made agreement upon the ratio of armaments impossible. Two examples will serve to illustrate this statement: the controversies between France and Germany at the World Disarmament Conference of 1932, and the conflict between the United States and the Soviet Union in the United Nations Atomic Energy Commission.

**THE WORLD DISARMAMENT CONFERENCE AND THE UNITED NATIONS COMMISSIONS.** The First World War made France the preponderant military power in Europe and in the world. It left Germany so thoroughly disarmed as to incapacitate it for war with any first-rate military power, let alone with France. This distribution of power persisted in principle, however modified by the secret rearmament of Germany and the increasing technological and strategic obsolescence of the French military establishment, when the World Disarmament Conference met in 1932. Germany's avowed purpose at the Conference was to change that distribution of power. France's avowed pur-

## *Politics among Nations*

pose was to maintain it. Germany tried to attain its goal by obtaining recognition of "equality of right" as between France and itself to be transformed gradually, that is, within the span of a number of years, into actual equality of armaments. France, on the other hand, tried to realize its objectives by countering the German principle of equality with the principle of security. The French conception of security meant in practice that any increase in German military strength would be matched by an increase in French power. France, however, was already close to having exhausted its own military potentialities, while Germany had not even begun to tap its resources in population and industrial potential, to mention only its two most spectacular and portentous military assets in view of its relations with France.

Under such circumstances, France, in order to be "secure" in its relations with a Germany of potentially superior power, had to look beyond its own borders for additions to its strength. France found these additions in three factors: in military alliances with Poland and the nations of the Little Entente — Czechoslovakia, Yugoslavia, and Rumania; in new collective guarantees of the territorial status quo of the Treaty of Versailles; in the compulsory judicial settlement of all international disputes on the basis of the international law of the Treaty of Versailles. If the French proposals had been adopted by the Conference, any increase in German military strength would have been neutralized and deprived of all political effects favorable to Germany. This would have been accomplished by judicial decisions upholding the status quo of Versailles and calling to its defense the combined might of virtually all the other nations of the globe. It is for this reason that the French proposals had no chance of being adopted. On the other hand, if the German plan had been adopted by the Conference, the international order of Versailles and the status quo established by the victory of the Allies in the First World War would have gradually, but inextricably, crumbled away until Germany, by virtue of its superior military potential, would have transformed itself from the vanquished into the victor.

Hence, the controversy between France and Germany as to the ratio of their respective armaments was in its essence a conflict over the distribution of power. Behind what the delegates to the Disarmament Conference expressed in the ideological terms of security vs. equality, retrospective analysis discovers the moving force of international politics: the desire to maintain the existing distribution of power, manifesting itself in a policy of the status quo, on the one hand, and the desire to overthrow the existing distribution of power, expressing itself in a policy of imperialism, on the other. To expect, then, that France and Germany could agree upon the ratio of their respective armaments was tantamount to expecting that they could agree upon the distribution of power between them. Agreement on the latter issue in the form of a compromise between actual French preponderance and potential German preponderance might perhaps — and the doubt looms large — have been possible in the twenties. It was out of the question on the eve of Hitler's ascent to power, and thus agreement on the ratio of armaments was likewise out of the question.

For Germany to give up the demand for equality in armaments would have meant to accept its inferiority in power as permanent and legitimate and



to renounce all aspirations to become again the predominant power in Europe. For France to give up its demands for security would have meant to relinquish its position as the preponderant power in Europe and as the first military power in the world and to acquiesce in the comeback of Germany as a first-rate power.) The impasse between France and Germany with respect to the ratio of their respective armaments was, therefore, incapable of solution in terms of disarmament. Since it was a manifestation of the struggle for predominance between the two countries, this impasse could have been solved only in terms of the general distribution of power between them, if it could have been solved at all.

The conflict between the United States and the Soviet Union over the control of atomic energy, of which the United Nations Atomic Energy Commission is the scene, is essentially a new production of the play which was staged at the World Disarmament Conference in the early thirties. The settings now are simpler, the language coarser; all scenes not necessary for the main plot have been cut out, and new actors have taken over. But the essentials of the plot and the ending have not changed. The United States now plays the role which France played after the First World War, and the Soviet Union recites the text which Germany made familiar to the world. The issue, in the language of disarmament, is again security vs. equality. The monopoly of the atomic bomb gives the United States a military advantage over the Soviet Union, which the United States is willing to give up only in return for adequate guarantees against any other nation's being able to use atomic weapons. During the period of transition from an atomic armament race to the abolition of all atomic armaments guaranteed by international safeguards, the United States would retain its superiority. This superiority would be fully and definitely relinquished only at the end of that period when the system of international guarantees would have proved to be in working order. Ultimately the American plan would transform the ratio in atomic weapons, which now stands at  $X : O$  in favor of the United States into the ratio of  $O : O$ .

This willingness on the part of the United States to give up this military advantage over the Soviet Union altogether seems to be in marked contrast to the French attitude toward Germany at the World Disarmament Conference; for France was willing to modify its advantage over Germany, but not to forego it. The difference in attitude, however, results from the difference between atomic and traditional weapons and thus tends rather to accentuate the essential similarity of both situations. The preponderance of the United States in atomic weapons is bound to be temporary. In the not too distant future the Soviet Union will certainly have atomic weapons. If the ratio of  $X : O$  is not transformed now into  $O : O$ , it will inevitably be transformed later into  $X : Y$ . Yet, concerning atomic weapons,  $X = Y$ . In other words, once the Soviet Union has atomic weapons, it matters little that the United States will have more atomic weapons than the Soviet Union. It requires only a limited number of atomic bombs to destroy the military potential of the United States. This destruction will deprive the United States of the ability to win a war against the Soviet Union, however much damage it might be able to do by dropping a superior number of atomic bombs on Russian territory.

## *Politics among Nations*

The situation is entirely different for traditional weapons. A preponderance in quantity in this case means generally a preponderance in quality. Nation A whose machine guns equal the quantity X is generally that much stronger in this category of weapons than nation B which possesses only the quantity Y of that weapon. The equation  $X = Y$  does not hold true here. Rather  $X - Y =$  the margin of superiority of A over B. It is for this reason that the disarmament policies of France in the thirties differed from the policies of the United States in the Atomic Energy Commission despite the essential similarity of the problem which both countries had to face.

The Russian conception of atomic disarmament reverses the sequence which the American plan envisages. Instead of security first, equality later, the Russian conception postulates the immediate establishment of the equation  $O = O$ , the creation of guarantees against atomic armaments to be left to later diplomatic negotiations, which might or might not succeed. In other words, the Soviet Union wants the United States to stop the manufacture of atomic weapons and to destroy its existing atomic weapons at once, without the Soviet Union giving any material guarantees on its part not to engage in such manufacture itself.

If this state of affairs could actually be brought about it would give the Soviet Union two military advantages. On the one hand, it would wipe out with one stroke the superiority of the United States over the Soviet Union with regard to atomic weapons, which is of course a very important, if not decisive, factor in the over-all military preponderance of the United States over the Soviet Union. On the other hand, it would give the Soviet Union an opportunity — its only opportunity — of gaining superiority in atomic weapons over the United States. The Soviet Union would also obtain equality in atomic weapons under the American plan; that is, the equality of zero, even though only in the future and with the proviso that this equality could never be transformed into superiority. The Russian plan would give the Soviet Union that equality of zero right away and with it its only chance to become superior to the United States some time in the future.<sup>12</sup>

It is significant in view of the fundamental interests involved that the general discussion on security, apart from the specific issue of atomic disarmament, has centered upon implementation of Article 43 of the Charter of the United Nations which provides for the establishment of a United Nations Armed Force. Consistent with its general position, the United States has declared the existence of a United Nations Armed Force, sufficient to give security from aggression to the member states, to be the precondition for disarmament. Equally consistent with its general position, the Soviet Union has denied that such a relation exists.<sup>13</sup> The issue of security before disarmament, stressed by the status quo nation, vs. security through disarmament, upheld by the imperialistic nation, again comes to the fore.

The conflict between the United States and the Soviet Union, like that between France and Germany of the early thirties, then, is fought on two levels:

<sup>12</sup> For the relevant discussions in the United Nations, see *U. N. doc. S/P.V. 106, 115, 117, 223. Atomic Energy Commission Official Records*, No. 1, pp. 7 ff; No. 2, pp. 26 ff; A. E. C./P.V./17.

<sup>13</sup> *U. N. doc S/C.3/S.R.1, S/C.3/Corr. 1.*

on the superficial level of disarmament and on the fundamental level of the struggle for power. On the level of disarmament the conflict resolves itself into a controversy between two theoretical conceptions: security first, equality later vs. equality first, security later. On the level of the struggle for power, the conflict is posed in terms of two antagonistic international policies: defense of the status quo anticipating its inevitable change within certain foreseeable limits vs. overthrow of the status quo. The United States seeks to maintain its superiority in atomic weapons as long as possible and under all circumstances to prevent that superiority from shifting to the Soviet Union. The Soviet Union, on the other hand, seeks to end the superiority of the United States as soon as possible and to gain superiority for itself. Thus, in the field of atomic weapons, the United States pursues potentially (that is, if security cannot be achieved) an out-and-out policy of the status quo, while the Soviet Union is ready to embark potentially (that is, if equality cannot be had without security) upon an out-and-out policy of imperialism.)

Such is the nature of the power conflict between the United States and the Soviet Union. Of this conflict the controversy on atomic disarmament and on the composition of the United Nations Armed Force is merely an outward expression, following the contours of the conflict as the cast of clay follows the shape of the form into which it is molded. As the cast can only be changed by changing the mold, (so the problem of atomic disarmament can only be solved through a settlement of the power conflict from which it has arisen.)

*b) Standards of Allocation*

(The question as to the ratio among the armaments of different nations is the most important problem which an attempt at disarmament must solve. Once it is solved another question must be answered. It is less fundamental than the problem of the ratio, but full of practical difficulties in which the power relations of the nations concerned are again reflected. This question concerns the standards according to which different types and quantities of armaments are to be allocated to different nations within the agreed ratio. The Preparatory and World Disarmament Conferences of Geneva had to face that question innumerable times. The voluminous literature which these conferences have left is in its futility and inconclusiveness a monument to the hopelessness of the task in view of the conditions under which it was undertaken.)

(At the World Disarmament Conference, Germany, as we have seen, demanded equality in armaments with France. France agreed to that ratio as an abstract principle, provided the problem of security could be solved to its satisfaction. However, once the ratio was agreed upon in the abstract, what did equality mean in the concrete with respect, let us say, to armed effectives, trained reserves, heavy artillery, total number and types of aircraft, and so forth?)

(The standard to be employed was obviously sought for in the military needs of the two countries. These military needs were defined in terms of defense. Defense against whom? The answer given implicitly and explicitly was: defense primarily against each other. It was the inevitable result of this

## *Politics among Nations*

definition that the military needs of the two countries could not be identical. The different strategic positions of the two countries — to mention, at this point, only one factor among many — required defensive armaments different in quality and quantity. Equality in armaments, then, could not mean mathematical equality in the sense that France and Germany should have armed effectives, trained reserves, artillery, and air forces absolutely equal in quality and quantity. Equality could only mean equality in the defensive position of each country against foreign attack.)

(It was, then, incumbent upon the World Disarmament Conference to evaluate, first, the risks of foreign attack against each country; second, the means of defense other than armaments, such as geographical location, self-sufficiency in food and raw materials, industrial capacity, number and quality of population; third, the need for armaments in view of the other two factors. This threefold task confronted the Conference with three difficulties which proved to be insuperable.)

✓ First, that task could not be accomplished without the evaluation of the power of one nation in comparison with the power of other nations. We have tried to show earlier in this book <sup>14</sup> how difficult, speculative, and, in certain areas, almost impossible such a comparative evaluation is. If the data of such an evaluation go into the standards for the allocation of armaments, these standards must become highly subjective and, hence, make for controversy rather than agreement.

✓ Second, that task requires the assessment of the political intentions of the governments concerned. Since all nations habitually protest their peaceful intentions, the recognition of the need for defensive armaments on the part of all nations implies mistrust of the peaceful declarations of all nations at least by some other nation. All nations declare that they must be able to defend themselves against attack, but with this declaration every nation imputes aggressive intentions at least to some other nation. To reach agreement among the nations concerned as to who must defend himself against whom is obviously made impossible by the very nature of the controversy.

Finally, and most importantly, the controversies which are bound to ensue on the issues thus raised will inevitably reflect the actual and anticipated policies of the nations concerned. The nation which has aggressive tendencies against another or fears aggressive tendencies on the part of another — and all nations are in the latter category — is compelled by considerations of self-interest to keep the estimate of its own defensive needs as high as possible and to reduce those of its rivals to the lowest possible point. In other words, what the different nations want to achieve through their foreign policies — the retention and aggrandizement of their own power and the containment and reduction of that of their rivals — is expressed in numerical terms in the evaluation of their own and other nations' military needs. The standards they apply are determined by their political aims and not by anything remotely resembling objective criteria. Therefore, these standards are incapable of determination through free agreement of the nations concerned without an agreed settlement of the political issues which call for armaments on the part of all

---

<sup>14</sup> See above, Chapter VIII.

nations. The problem of the standards for the allocation of armaments, then, presents itself in the same terms as the problem of the ratio: political settlement must precede disarmament. Without political settlement, disarmament has no chance for success.

(The two striking illustrations of this relation between political settlement and agreement on the standards for the allocation of armaments are again provided by the conflict between France and Germany at the World Disarmament Conference and by the antagonism between the United States and the Soviet Union in the United Nations.)

In view of their unsettled conflict over the status quo of Versailles, France translated the abstract ratio of equality into standards of actual armaments apt to perpetuate its preponderance. On the other hand, Germany transformed the same ratio into concrete standards which, if effectuated, would have carried it to preponderance over France. Thus France insisted upon its need for a larger army than Germany's because of the larger German population and its greater rate of increase. Germany countered by pointing to the superiority of France in trained reserves and to the larger reserves of manpower and raw materials in the French colonial empire. Germany demanded *a certain amount of artillery and airplanes because of its geographical position in the midst of potentially hostile nations*. France denied that need by reminding the Conference of its own special defense needs in view of its lack of natural strategic frontiers with Germany and of the fact that thrice within a century France had become the victim of German invasion. One could write the history of the World Disarmament Conference in terms of that conflict for power between France and Germany, a conflict which precluded even agreement on small technical details. The contradictory claims for power of the competing nations were reflected in their contradictory claims for arms.

However, aside from the political issues which stood between France and Germany, the problem of comparative evaluation presented a formidable obstacle with which the World Disarmament Conference wrangled in vain. What was the value of 100,000 trained French reserves in terms of a corresponding number of effectives of the German Army? Was it 50,000, 60,000, 80,000, 100,000, or perhaps 120,000? What was the margin of superiority of German industrial capacity over the French worth in terms of numbers of French tanks, artillery, and aircraft? How many Germans in excess of the French population were equal to how many French colonials? Obviously there can be no answer to such questions in the terms of mathematical exactitude in which the World Disarmament Conference conceived of them. What answer there is to such questions must be sought by means of political bargaining and diplomatic compromise. In the historic instance which we have been considering the employment of such methods presupposed the settlement of the political conflict. Its continuance made it impossible for France and Germany to agree on standards for the allocation of different quantities and types of arms through the techniques of accommodating diplomacy.

Contemporary attempts at disarmament have not even reached the stage where a subcommittee of the United Nations Commission for Conventional Armaments might raise the question of how many divisions of Russian infantry equal one American atomic bomb. Yet in the preliminary discussions

## *Politics among Nations*

concerning the frame of reference for the work of the Commission it was just the relation between the American monopoly of the atomic bomb and the Russian superiority in armed effectives which gave rise to controversies and illuminated the power conflict between the United States and the Soviet Union. Concerning the actual distribution of armed strength between the United States and the Soviet Union, two fundamental facts and interests determine the policies of the two nations. The two fundamental facts are the temporary American monopoly of the atomic bomb and the actual and potential military preponderance of the Soviet Union on the continents of Europe and Asia. The paramount interest of the Soviet Union is to make the period of American supremacy in atomic weapons as short as possible, while perpetuating its own military preponderance on the continents of Europe and Asia. The United States is vitally interested in retaining its monopoly of atomic weapons as long as possible and to reduce the Russian preponderance on those continents. The policies of both countries with respect to disarmament in traditional weapons are the true reflection of those facts and interests.

The Soviet Union is anxious to make an end to the American monopoly of the atomic bomb. To that purpose it tried to make the frame of reference of the Commission for Conventional Armaments so wide as to include atomic weapons. So wide a reference would have given the Soviet Union another avenue of attack against the American monopoly. Furthermore, it would have given the Soviet Union the opportunity of playing out its superiority in other fields, especially in armed effectives, against the American position. The United States, on the other hand, is anxious to keep the monopoly of the atomic bomb as long as possible and to use its superiority in this respect to full advantage by keeping the issue of atomic disarmament strictly apart from all the other issues pending between itself and the Soviet Union. To that end, the United States has insisted that the United Nations Atomic Energy Commission remain solely responsible for atomic disarmament. Knowing that its monopoly can only be temporary, the United States has also insisted that atomic disarmament have priority over all other types of disarmament. Only if agreement on atomic disarmament plus security has been reached before other nations have acquired atomic weapons can the United States remain secure from atomic attack.<sup>15</sup>

Thus, whether the issue is one of the over-all ratio of the armaments of different nations or whether the issue is the standard for allocating different types and quantities of arms, these issues are incapable of solution in their own terms, so long as the conflicts of power from which they have arisen remain unsolved.

### *c) Does Disarmament Mean Reduction of Armaments?*

Let us consider the few instances in which these issues were actually solved and agreement on the ratio and allocation of armaments was reached, and let us ask ourselves what was the effect of these agreements on the quality

<sup>15</sup> For the relevant discussions in the United Nations, see *U. N. doc. S/C.3/S.R.1, S/C.3/S.R.5, S/C.3/Corr. 1, S/C.3/12.*

and quantity of armaments of the nations concerned. Three treaties need to be considered: the Washington Treaty of 1922, the London Treaty of 1930, and the Anglo-German Agreement of 1935.

By virtue of the Washington Treaty, the American, British, and Japanese strength in capital ships was reduced by about 40 per cent. A total of seventy ships was scrapped by the signatories. To that extent the Washington Treaty provided for a general reduction of armaments. Two factors must, however, be noted. On the one hand, the reduction was to be only temporary. The Treaty stipulated that the five signatories could in 1931 start to build replacements which by 1942 would have established the ratio of 5:5:3:1.67:1.67. In 1931, the period of the reduction of armaments with regard to capital ships came to an end and was replaced by a period of regulated competition for armaments.

On the other hand, due to the rapid development of the technology of war, especially with regard to fire power and aircraft, the kind of capital ships in use during the First World War tended to become obsolete at a faster rate than any other type of weapon with the exception of airplanes. Mindful of the lessons of the First World War, an increasing number of experts believed that the battleship as such had become outmoded, that at best it was a waste of money, and that the future of naval power lay in light and speedy vessels with high fire power. If it is assumed that such considerations should have had weight with the signatories of the Washington Treaty, the reduction in battleship strength would then appear as recognition of the decline of the battleship as a weapon. Since the signatories would in any event have scrapped a considerable number of their battleships, they might as well do it in concert and according to plan as by unregulated competition.

As if to support that assumption, the Washington Treaty was the signal for an armament race among the signatories in all vessels not covered by the Treaty, especially in cruisers, destroyers, and submarines. Those were, as we have seen, the vessels most important for modern naval war. At least in its effects, therefore, the Washington Treaty neutralized competition in that sphere of naval armaments where competition was not likely to be keen. By the same token it freed energies and material resources and thereby stimulated competition in those branches of naval armaments in which the naval powers were most likely to compete.

Whatever the motives of the signatories and whatever its effects, the Washington Treaty actually limited certain naval armaments. The same cannot be said of either the London Treaty of 1930 or of the Anglo-German Agreement of 1935. The main achievement of the London Treaty was agreement among the United States, Great Britain, and Japan with regard to the tonnage of cruisers, destroyers, and submarines. The London Treaty purported to provide for the limitation of the naval strength of the respective nations in these categories of vessels. In actuality, however, it provided for the rearmament of the United States and Japan within the limits established by the maximum strength of the British Navy in these categories.

The Treaty gave parity to the United States and Great Britain with Japan trailing at about two-thirds of the maximum. By doing so, however, the

## *Politics among Nations*

Treaty simply recognized as legitimate the existing naval supremacy of Great Britain, especially in cruisers, and perpetuated this supremacy for all practical purposes. For the tonnage allocated by the Treaty was so high as to be out of reach for Japan and to be attainable by the United States at a cost (a billion dollars over five years) which was then considered by American public opinion as out of the question. In other words, the Treaty allowed the United States to bring its naval strength in the three categories up to Great Britain's if it wanted to spend the money, which obviously the United States did not.<sup>16</sup> The Treaty allowed Japan to have about two-thirds of the tonnage of the United States and Great Britain if it could afford to build this fleet, which obviously Japan could not. The only contribution which the London Treaty made to the limitation of naval armaments, then, consisted in the establishment of a maximum which no signatory was allowed to exceed and which the United States and Japan were unlikely even to reach. Thus, far from reducing armaments, the Treaty allowed for their increase within certain limits.

Furthermore, even this agreement as to maximum tonnage was in its very existence qualified by the continuing freedom of France and Italy, who did not sign the Treaty, to increase at will their armaments in the respective categories. In order to meet a possible threat from this quarter to the interests of any of the signatories, especially of Great Britain in the Mediterranean, the Treaty restored complete freedom of action to any signatory if in its opinion new construction by a non-signatory adversely affected its national security. In case a signatory increased its tonnage on these grounds beyond the limits of the Treaty, the two other nations were allowed to increase their own naval strength in proportion. What would have remained of the London Treaty in such an exigency would have amounted to nothing more than an armaments race whose pace would follow a certain rhythm determined by one or the other of the great naval powers.

Not more than a word need be said about the Anglo-German Naval Agreement of 1935. This agreement, couched in the terminology of limitation, had nothing to do with disarmament. It provided frankly for the naval rearmament of Germany within limits which Germany could not and did not want to exceed at that time and which, short of war, Great Britain could not prevent Germany from reaching.

### *d) Does Disarmament Mean Peace?*

Disarmament has been capable of realization only under extraordinary conditions. Even when it seemed to have been realized, more often than not disarmament meant increase in armaments rather than reduction. These considerations, however, are but preliminary to the question which is decisive in the context of our discussion. What is the bearing of disarmament upon the issues of international order and peace? Provided the nations of the earth could agree upon quantitative or qualitative disarmament and would actually

<sup>16</sup> The United States spent for the construction of ships of all kinds in the fiscal years 1931-35 a total of somewhat more than 324 million, that is, less than a third of a billion dollars. (*The World Almanac for 1947*, p. 812.)



disarm in accordance with the agreement, how would such reduction of all, or elimination of certain, armaments affect international order and peace?

At the foundation of the modern philosophy of disarmament there is the assumption that men fight because they have arms. From this assumption the conclusion follows logically that if men would give up all arms all fighting would become impossible. In international politics only the Soviet Union has actually taken this conclusion seriously — and it is questionable whether it was very serious after all — by submitting to the World Disarmament Conference of 1932 proposals for complete, universal disarmament (with the exception of light arms for police functions). The contemporary Russian attitude with respect to atomic disarmament is somewhat in keeping with that position. But even where less extreme conclusions are drawn, the proposition is tacitly admitted that there exists a direct relation between the possession of arms, or at least of certain kinds and quantities of arms, and the issue of war and peace.

Such a relation does indeed exist, but it is the reverse from that which the advocates of disarmament assume it to be. Men do not fight because they have arms. They have arms because they deem it necessary to fight. Take away their arms, and they will either fight with their bare fists or get themselves new arms with which to fight. What makes for war are the conditions in the minds of men which make war appear the lesser of two evils. In those conditions must be sought the disease of which the desire for, and possession of, arms is but a symptom. So long as men seek to dominate each other, to take away each other's possessions, fear and hate each other, they will try to satisfy their desires and to put their emotions to rest. Where an authority exists strong enough to direct the manifestations of those desires and emotions into nonviolent channels, men will seek only nonviolent instruments for the achievement of their ends. In a society of sovereign nations, however, which by definition constitute the highest authority within the respective national territories, the satisfaction of those desires and the release of those emotions will be sought by all the means which the technology of the moment provides and the prevailing rules of conduct permit. These means may be arrows and swords, guns and bombs, gas and directed missiles, bacteria and atomic weapons.

To reduce the quantity of weapons actually or potentially available at any particular time could have no influence upon the incidence of war; it could conceivably affect its conduct. Nations limited in the quantity of arms and men would concentrate all their energies upon the improvement of the quality of such arms and men as they possess. They would, furthermore, search for new weapons which might compensate them for the loss in quantity and assure them an advantage over their competitors.

To eliminate certain types of weapons altogether would have a bearing upon the technology of warfare and through it upon the conduct of hostilities. It is hard to see how it could influence the frequency of war or do away with war altogether. Let us suppose that it were possible, for instance, to outlaw the manufacture and the use of atomic bombs. What would be the effect of such a prohibition, provided it were universally observed? It would simply reduce the technology of war to the level of the morning of July 16, 1945,

## *Politics among Nations,*

before the first atomic bomb was exploded in New Mexico. The nations adhering to the prohibition would employ their human and material resources for the development and discovery of weapons other than atomic bombs. The technology of warfare would change, but not the incidence of war.

The abortive attempts of Great Britain to have the World Disarmament Conference outlaw aggressive, in contrast to defensive, weapons illustrate the impossibility of solving the problem by way of qualitative disarmament. Great Britain started with the assumption that the ability to wage aggressive war was the result of the possession of aggressive weapons. The conclusion followed that without aggressive weapons there could be no aggressive war. However, the conclusion falls with the assumption. Weapons are not aggressive or defensive by nature, but are made so by the purpose they serve. A sword, no less than a machine gun or a tank, is an instrument of attack or defense according to the intentions of its user. A knife can be used for carving meat, for performing a surgical operation, for holding an attacker at bay, or for stabbing somebody in the back. An airplane can serve the purpose of carrying passengers and freight, of reconnoitering enemy positions, of attacking undefended cities, of dispersing enemy concentrations poised for attack.

The British proposals really amounted to an attempt to make the status quo secure from attack by outlawing the weapons most likely to be used for overthrowing it. They tried to solve the political problem by manipulating some of the instruments which might serve its solution by violent means. Even if it should have been possible to agree on the characteristics of aggressive weapons, the political problem would have reasserted itself in the use of whatever weapons remained available. Actually, however, agreement on that point was out of the question. For the weapons which Great Britain deemed to be aggressive happened to be identical with those upon which the anti-status quo nations placed their main reliance for achieving their political ends. For instance, Great Britain thought that battleships were defensive and submarines were offensive weapons, while nations with small navies put it the other way around. As part of an enterprise generally beset by contradictions and doomed to futility, the British proposals for qualitative disarmament bear to a peculiar degree that lack of political insight which brought the World Disarmament Conference to an inglorious end.

Let us finally assume that standing armies and their weapons were completely outlawed and would in consequence disappear. The only probable effect of such a prohibition on war would be the limited and primitive character of its beginning. The armaments race among hostile nations would simply be postponed to the beginning of hostilities instead of preceding and culminating in it. The declaration of war would then be the signal for the warring nations to marshal their human and material resources and, more particularly, their technological skills for the speedy manufacture of all the implements of war which the technological development makes feasible. It is indeed possible to outlaw the atomic bomb; but it is not possible to outlaw the technological knowledge and ability to create atomic bombs. It is for this obvious reason that the prohibition of particular weapons has generally not been effective in war. This has been true, for instance, of the use of light-

weight projectiles charged with explosives or inflammable substances, of the bombing of civilians from airplanes, and of unlimited submarine warfare.<sup>17</sup>

Victory is the paramount concern of warring nations. They may observe certain rules of conduct with regard to the victims of warfare; they will not forego the use of all the weapons which their technology is able to produce. The observance of the prohibition of the use of poison gas in the Second World War is but an apparent exception. All the major belligerents manufactured poison gas; they trained troops in its use and in defenses against it and were prepared to use it if such use would seem to be advantageous. Only considerations of military expediency deterred all belligerents from making use of a weapon of which they had all availed themselves with the intention to use it if necessary.

That quantitative and qualitative disarmament affects the technology and strategy, but not the incidence of war, is clearly demonstrated by the results of the disarmament which was imposed upon Germany by the Treaty of Versailles. This disarmament was quantitative as well as qualitative and so thorough as to make it impossible for Germany to wage again a war similar in kind to the First World War. If this had been the purpose it was fully realized. If the purpose, however, was to incapacitate Germany forever to wage war of any kind — and this was the actual purpose — the disarmament provisions of the Treaty of Versailles were a spectacular failure. They forced the German General Staff to part with the methods of warfare prevalent in the First World War and to turn their ingenuity to new methods not prohibited by the Treaty of Versailles because they were not widely used or not used at all during the First World War. Thus the Treaty of Versailles — far from depriving Germany of the ability to wage war again — virtually compelled Germany to prepare for the Second World War instead of, like France, for a repetition of the First World War. Disarmament in terms of the technology and strategy of the First World War, then, was for Germany actually a blessing in disguise. Disarmament made it virtually inevitable for Germany to refashion its military policy along the lines of the future rather than of the past.

It has, however, been suggested that, while disarmament could not by itself abolish war, it could to a great degree lessen the political tensions which might easily lead to war. More particularly, the unregulated armaments race with the fears it causes and the ever increasing financial burdens it imposes is apt to lead to such an intolerable situation that all or some parties to the race will prefer its termination by whatever means, even at the risk of war, to its indefinite continuation.

Disarmament or at least regulation of armaments is an indispensable step in a general settlement of international conflicts. It can, however, not be the first step. Competition for armaments reflects, and is an instrument of, competition for power. So long as nations advance contradictory claims in the contest for power, they are forced by the very logic of the power contest to advance contradictory claims for armaments. Therefore, a mutually satisfac-

<sup>17</sup> For the respective international treaties, see above, pp. 178 ff., 215.

## *Politics among Nations*

tory settlement of the power contest is a precondition for disarmament. Once the nations concerned have agreed upon a mutually satisfactory distribution of power among themselves, they can then afford to reduce and limit their armaments. Disarmament, in turn, will contribute greatly to the general pacification. For the degree to which the nations can come to terms upon disarmament will be the measure of the political understanding which they were able to achieve.

Disarmament, no less than the armaments race, is the reflection of the power relations among the nations concerned. Disarmament, no less than the armaments race, reacts upon the power relations from which it arose. As the armaments race aggravates the struggle for power through the fear it generates and the burdens it imposes, so disarmament contributes to the improvement of the political situation by lessening political tensions and by creating confidence in the purposes of the respective nations. Such is the contribution which disarmament can make to the establishment of international order and the preservation of international peace. It is an important contribution, but it is obviously not the solution of the problems of international order and peace.

## CHAPTER XXII

### *Security*

The more thoughtful observers have realized that the solution for the problem of disarmament does not lie within disarmament itself. They have found it in security. Armaments are the result of certain psychological factors. So long as these factors persist, the resolution of nations to arm themselves will also persist, and that resolution will make disarmament impossible. The generally professed and most frequent actual motive for armaments is fear of attack, that is, a feeling of insecurity. Hence, it has been argued that what is needed is to make nations actually secure from attack by some new device and thus to give them a feeling of security. The motive force and the actual need for armaments would then disappear; for nations would find in that new device the security which they had formerly sought in armaments. Since the end of the First World War, two such devices have been agreed upon by all politically active nations of the world: collective security and an international police force.

#### I. COLLECTIVE SECURITY

We have already discussed the legal aspects of the problem of collective security as it has presented itself in Article 16 of the Covenant of the League of Nations and in Chapter VII of the Charter of the United Nations.<sup>1</sup> It remains for us now to consider the political problems to which collective security gives rise, with special reference to the problem of international order and peace.

In a working system of collective security the problem of security is no longer the concern of the individual nation to be taken care of by armaments and other elements of national power. Security becomes the concern of all nations which will take care collectively of the security of each of them as though their own security were threatened. If A threatens B's security, C, D, E, F, G, H, I, J, and K will take measures on behalf of B and against A as though A threatened them as well as B, and vice versa.<sup>2</sup> One for all and all for one is the watchword of collective security.

<sup>1</sup> See above, pp. 232 ff.

<sup>2</sup> See the diagram below, p. 334.

## *Politics among Nations*

We have already pointed out that the logic of collective security is flawless, provided it can be made to work under the conditions prevailing on the international scene.<sup>3</sup> For collective security to operate as a device for the prevention of war, three assumptions must be fulfilled: (1) the collective system must be able to muster at all times such overwhelming strength against any potential aggressor or coalition of aggressors that the latter would never dare to challenge the order defended by the collective system; (2) at least those nations whose combined strength would meet the requirement under (1) must have the same conception of security which they are supposed to defend; (3) those nations must be willing to subordinate whatever conflicting political interests may still separate them to the common good defined in terms of the collective defense of all member states.

It is conceivable that all these assumptions may be realized in a particular situation. The odds, however, are strongly against such a possibility. There is nothing in past experience and in the general nature of international politics to suggest that such a situation is likely to occur. It is indeed true that under present conditions of warfare, no less than under those of the past, no single country is strong enough to defy a combination of all the other nations with any chance for success. Yet it is extremely unlikely that in an actual situation only one single country would be found in the position of the aggressor. Generally, more than one country will actively oppose the order which collective security tries to defend, and other countries will be in sympathy with that opposition.

The reason for this situation is to be sought in the character of the order defended by collective security. That order is of necessity the status quo as it exists at a particular moment. Thus the collective security of the League of Nations aimed necessarily at the preservation of the territorial status quo as it existed when the League of Nations was established in 1919. However, there were already in 1919 a number of nations strongly opposed to that territorial status quo — the nations defeated in the First World War as well as Italy which felt itself despoiled of some of the promised fruits of victory. Other nations, such as the United States and the Soviet Union, were at best indifferent toward the status quo. For France and its allies, who were the main beneficiaries of the status quo of 1919 and most anxious to defend it by means of collective security, security meant the defense of the frontiers as they had been established by the peace treaties of 1919 and the perpetuation of their predominance on the continent of Europe. Security for the dissatisfied nations meant the exact opposite: the rectification of those frontiers and a general increase in their power relative to France and its allies.

This grouping of nations into those in favor of the status quo and those opposed to it is not at all peculiar to the period after the First World War. It is, as we know, the elemental pattern of international politics. As such it recurs in all periods of history. Through the antagonism between status quo and imperialistic nations it provides the dynamics of the historic process. This antagonism is either resolved in compromise or in war. Only under the assumption that the struggle for power as the moving force of international

---

<sup>3</sup> See above, p. 232.

politics might subside or be superseded by a higher principle can collective security have a chance for success. Since, however, nothing in the reality of international affairs corresponds to that assumption, the attempt to freeze the particular status quo by means of collective security is in the long run doomed to failure. In the short run collective security may succeed in safeguarding a particular status quo because of the temporary weakness of the opponents. Its failure to succeed in the long run, under the assumption of continuing conflicting interests, is due to the absence of the third assumption upon which we have predicated the success of collective security.

In the light of historic experience and the actual nature of international politics, we must assume that conflicts of interest will continue on the international scene. Collective security, then, can succeed only on the further assumption that all or virtually all nations will come to the defense of the status quo, threatened in the security of a particular nation, even at the risk of war, regardless of whether they could justify such a policy in view of their own individual interests. In other words, what collective security demands of the individual nations is to forsake national egotisms and the national policies serving them. Collective security expects the policies of the individual nations to be inspired by the ideal of mutual assistance and a spirit of self-sacrifice which will not shrink even from the supreme sacrifice of war should it be required by that ideal.

Hence, this third assumption is really tantamount to the assumption of a moral revolution infinitely more fundamental than any moral change that has occurred in the history of Western civilization. It is a moral revolution not only in the actions of statesmen representing their countries, but also in the actions of plain citizens. Not only are the latter expected to support national policies which are at times bound to run counter to the interests of the nation, they are also expected to be ready to lay down their lives for the security of any country anywhere on the globe. It can be maintained that if men everywhere would feel and act that way the lives of all men would be forever secure. The truth of the conclusion is as much beyond dispute as the hypothetical character of the premise.

Men generally do not feel and act, either as individuals among themselves or as members of their nations with regard to other nations, as they ought to feel and act if collective security is to succeed under the conditions of international politics as they are. And there is, as we have tried to show,<sup>4</sup> less chance today than there has been at any time in modern history that they would act in conformity with moral precepts of a supranational character if such action might be detrimental to the interests of their respective countries. In his relations with other individuals within the national society, the individual will give up the pursuit of his egotistic ends only under the threat of severe punishment or under the overwhelming moral and social pressure generated by war or other national emergencies of a spectacular character.

There is no law-enforcing agency above the individual nations and there are no overwhelming moral and social pressures to which they could be subjected. Thus they are bound always to pursue what they regard to be their

<sup>4</sup> See above, pp. 184 ff.

## *Politics among Nations*

own national interests. Conflicts between national and supranational interests and morality are inevitable at least for some nations under any conceivable conditions which might call for the realization of collective security. Those nations cannot help resolving such a conflict in favor of their own individual interests and thus paralyzing the operations of the collective system.

In the light of this discussion, we must conclude that collective security cannot be made to work in the contemporary world as it must work according to its ideal assumptions. Yet it is the supreme paradox of collective security

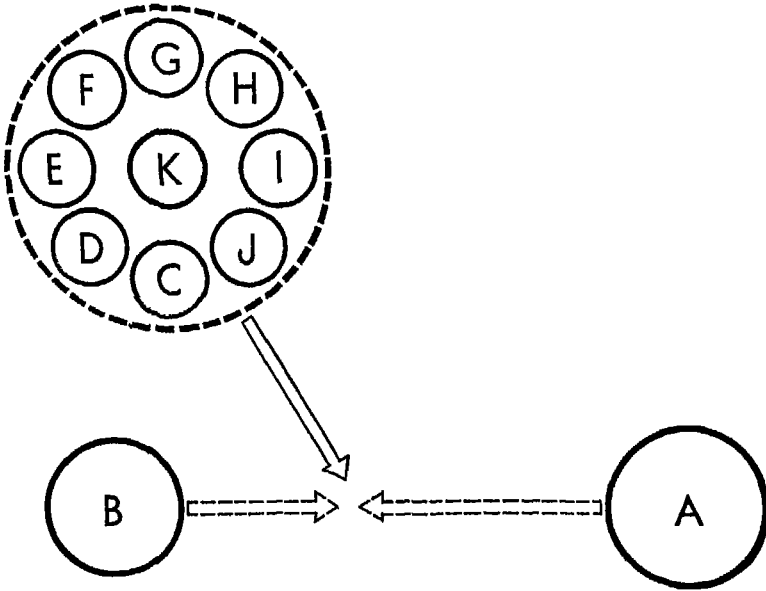

THE IDEAL OF COLLECTIVE SECURITY

that any attempt to make it work with less than ideal perfection will have the opposite effect from what it is supposed to achieve. It is the purpose of collective security to make war impossible by marshaling in defense of the status quo such overwhelming strength that no nation will dare to resort to force in order to change the status quo. However, the less ideal are the conditions for making collective security work, the less formidable will be the combined strength of the nations willing to defend the status quo. If an appreciable number of nations are opposed to the status quo and if they are unwilling to give the common good, as defined in terms of collective security, precedence over their opposition, the distribution of power between the status quo and anti-status quo nations will no longer be overwhelmingly in favor of the former. Rather the distribution of power will take on the aspects of a balance of power which may still favor the status quo nations, but no longer to such an extent as to operate as an absolute deterrent upon those opposed to the status quo.

The attempt to put collective security into effect under such conditions—



which are, as we know, the only conditions under which it can be put into effect — will not preserve peace, but will make war inevitable. And not only will it make war inevitable, it will also make localized wars impossible and thus make war universal. For, if under the regime of collective security as it actually would work under contemporary conditions, A attacks B, then C, D, E, and F might honor their collective obligations and come to the aid of B, while G and H might try to stand aside and I, J, and K might support A's aggression. Were there no system of collective security, A might attack B

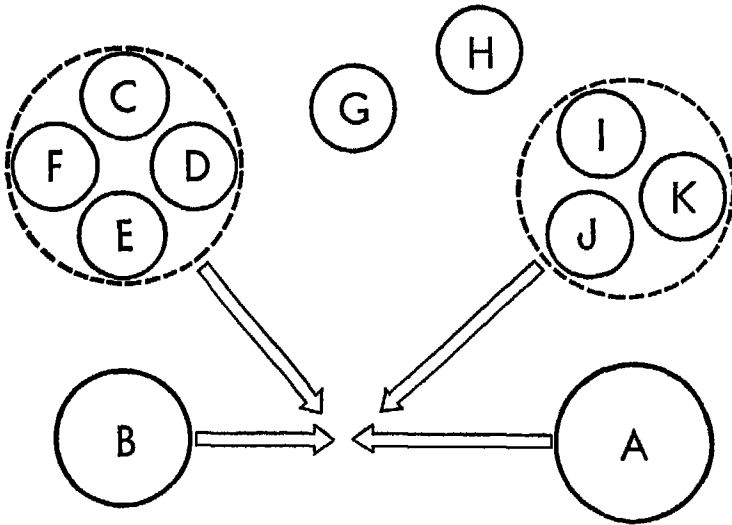

THE REALITY OF COLLECTIVE SECURITY

with whatever consequences that might have for A and B, yet with no other nations being involved in war. Under a system of collective security operating under less than ideal conditions, war between A and B or between any other two nations anywhere in the world is of necessity tantamount to war among all or at best most nations of the world.

From the beginning of the modern state system to the First World War, it was the main concern of diplomacy to localize an actual or threatened conflict between two nations, in order to prevent it from spreading to other nations. The efforts of British diplomacy in the summer of 1914 to limit the conflict between Austria and Serbia to those two countries are an impressive, however unsuccessful, example. By the very logic of its assumptions, the diplomacy of collective security must aim at transforming all local conflicts into world conflicts. If this cannot be one world of peace, it cannot help being one world of war. Since peace is supposed to be indivisible, it follows that war is indivisible, too. Under the assumptions of collective security, any war anywhere in the world, then, is potentially a world war. Thus a device intent upon making war impossible ends up in making war universal. Instead of preserving peace between two nations, collective security, as it must actually

## *Politics among Nations*

operate in the contemporary world, is bound to destroy peace among all nations.<sup>5</sup>

### *a) The Italo-Ethiopian War*

These comments on collective security as a practical device for preserving peace are borne out by the experiences made when, for the first and thus far the last time, an attempt was made to apply collective security in a concrete case — the League of Nations' sanctions against Italy in 1935–36. After Italy's attack on Ethiopia, the League of Nations put the mechanism of collective security provided for in Article 16 of the Covenant into motion. It soon became apparent that none of the assumptions upon whose realization the success of collective security depends were present and could have been present under the actual conditions of world politics.

The United States, Germany, and Japan were not members of the League system of collective security and were, furthermore, divided in their sympathies. Germany had already openly embarked upon policies designed to overthrow the existing status quo in Europe. Japan was already well on its way to overthrow the status quo in the Far East. Both, therefore, could only look with favor on an undertaking which, by overthrowing the status quo in an out-of-the-way region, would weaken the position of Great Britain and France who were vitally interested in the preservation of the status quo in Europe and the Far East. The United States, on the other hand, approved of the attempts to strengthen the defense of the status quo, while the temper of public opinion in the country prevented it from taking an active part in such attempts. The nations who were prepared to do everything they could for the success of the League experiment were either too weak to do much of consequence, such as the Scandinavian countries, or, as in the case of the Soviet Union, their ulterior motives were suspect. Furthermore, the Soviet Union was lacking in naval strength, indispensable under the circumstances, and had no access to the theater of decisive operations without the co-operation of the interjacent countries, which was not forthcoming.

Thus the case of collective security vs. Italy was in essence the case of Great Britain and France vs. Italy. This was a far cry from the ideal prerequisite of a concentration of overwhelming power which no prospective lawbreaker would dare to challenge. It is, of course, true that the combined strength of Great Britain and France would have sufficed to crush Italy. Yet Great Britain and France were not only members of the League system of collective security; they had other moral, legal, and political commitments. Nor were they engaged in defending the status quo against Italy alone. They were involved in a world-wide struggle for power, of which the conflict with Italy was only one — and not the most important — segment. While they were opposing Italy's attack upon the status quo, they could not overlook the progressing attack of Japan, nor could they be oblivious to the preparations for attack going on east of the Rhine. Nor, finally, were they able to divorce their fear of communism as a revolutionary movement threatening the do-

<sup>5</sup> How collective security might operate successfully on the regional level, that is, in the shadow of a great power has been indicated above, pp. 131 ff.

mestic status quo from their policies toward the Soviet Union. What Great Britain and France conceived as their national interests contradicted what collective security required them to do. More particularly, they were resolved and made their resolution known not to go so far in defense of Ethiopia as to risk war with Italy. In the already quoted words of Winston Churchill: "First, the Prime Minister had declared that sanctions meant war; secondly, he was resolved that there must be no war; and thirdly, he decided upon sanctions. It was evidently impossible to comply with these three conditions." <sup>6</sup>

Unwilling to subordinate their national interests to the requirements of collective security, Great Britain and France were also unwilling to pursue their national interests without regard to collective security. This was the fatal error of British and French foreign policy with regard to the Italo-Ethiopian War. By pursuing either cause half-heartedly and without consistency, they failed in both. Not only did they not save the status quo in East Africa, they also drew Italy into the arms of Germany. They destroyed the collective system of the League of Nations as well as their own prestige as defenders of the status quo. Among the causes for the increasing boldness of the anti-status quo nations in the late thirties, culminating in a war of aggression, this loss of prestige holds a prominent place.

The debacle of collective security, when it was once applied in an actual case of aggression, conveys two important lessons. It shows the contradiction between an ideally perfect scheme of reform and a political reality which lacks all the assumptions upon which the success of the scheme was predicated. It shows also the fatal weakness of a foreign policy which is incapable of deciding whether to be guided by the national interest, however defined, or by a supranational principle embodying the common good of the community of nations.

## 2. AN INTERNATIONAL POLICE FORCE

The idea of an international police force goes a step beyond collective security in that the application of collective force against an actual or prospective lawbreaker no longer lies within the control of the individual nations. The international police would operate under the command of an international agency which would decide when and how to employ it. No such police force has ever operated as a permanent international organization. The members of the United Nations are, however, obligated by Articles 42 ff. of the Charter to create such an international police force in the form of a United Nations Armed Force. No progress has yet been made in executing that obligation.

The hopes for the preservation of peace which have been connected with an international police force since the end of the First World War are derived from an analogy with the peace-preserving functions which the police performs in domestic societies. This analogy is, however, misleading on three grounds.

---

<sup>6</sup> *London Evening Standard*, June 26, 1936,

## *Politics among Nations*

Domestic societies are composed of millions of members of which at any one time normally only a very small fraction is engaged in violating the law. The spread of power among members of domestic societies is extreme, since there are very powerful and very weak members; yet the combined power of law-abiding citizens will normally be far superior to any combination of even the most powerful lawbreakers. The police as the organized agency of the law-abiding majority does not need to exceed relatively small proportions in order to be able to cope with any foreseeable threat to law and order.

In these three respects the international situation is significantly different. International society is composed of a relatively small number of members, amounting to about sixty sovereign states. Among these there are giants, like the United States and the Soviet Union, and pygmies, such as Luxemburg and Nicaragua. What is more important, the power of any one of the giants constitutes a very considerable fraction of the total power of the community of nations. A giant in combination with one or two second-rate nations or a few small ones may easily exceed the strength of all the other nations combined. In view of such a formidable potential opposition, a police force of truly gigantic dimensions would obviously be needed if it should be able to squelch an infringement of law and order without transforming every police action into full-scale war. This would still be true, only on a proportionately smaller scale, if general disarmament should reduce drastically the armed forces of the individual nations. For the international police would still have to constitute a counterweight of overwhelming superiority to the military spirit and training, the industrial capacity, strategic advantages, in short, the power potential of the great powers, which in case of conflict could easily be transformed into actual military strength.

Under the assumption, then — which is indeed a mere hypothetical assumption — that nations would be willing to surrender the instruments for the protection and furtherance of their own interests to an international police force, how is such an international police force to be composed? The nature of international society as it actually is allows no satisfactory answer to that question.

In domestic societies the police force is naturally composed of members who are fully identified with the existing law and order. Even if one would assume that among them there are some opposed to the existing law and order, proportionate in numbers to the segment of the total population opposed to it, the number of the disaffected would be so small as to be virtually negligible and unable to affect the striking power of the police. An international police force would necessarily have to be composed of a proportionate or equal number of citizens of the different nations. These nations, however, as we have seen, are virtually always divided into defenders and opponents of the existing status quo, that is, of the existing law and order. Their citizens as members of the international police force could not but share the national preferences in this respect. Are they to be expected to fight against their own countries in defense of a status quo to which they, as members of their nations, must be opposed? Given the relative strength of national and international loyalties in the contemporary world, in case of conflict the national loyalties

could not but attract the respective members of the international police force like so many magnets, thus dissolving the international police force before it could ever meet a challenge to the existing law and order.

Considerations of this kind underlie the differences of opinion which have made it impossible for the United Nations Military Staff Committee to agree on the composition of an international police, the United Nations Armed Force. The debate on the United Nations Armed Force posed again the problem of the ratio. This problem arose with reference to the share of the different nations in the composition of the Armed Force. The United States has suggested that the contingents of the individual nations be proportionate to their own military strength. The Soviet Union has maintained that the shares of all nations ought to be equal regardless of the size of their military establishments. In this controversy the general conflict between the United States and the Soviet Union has reasserted itself.

The existence of a United Nations Armed Force would imply the possibility of creating a counterweight to the military preponderance of the Soviet Union on the continents of Europe and Asia. If the member states were represented in the United Nations Armed Force proportionate to their armed strength, the Soviet Union and its friends would provide a large fraction of the army of the Armed Force. Their contribution to the air force would certainly be inferior to the total and their share in the navy of the United Nations Armed Force would be negligible. Those are, however, the weapons to which, by virtue of its strategic position, the Soviet Union is most vulnerable. Since the Soviet Union and its allies are hopelessly outvoted in the Security Council, which would have command of the Armed Force, the latter would be more likely to be used against the Soviet Union than against anybody else. Since, furthermore, the Soviet Union is the main opponent of the status quo, the defense of which would be the main task of the Armed Force, there would also be greater opportunity for using the latter against the Soviet Union than against anybody else.

Thus the United States is vitally interested in making the United Nations Armed Force as strong as possible in relation to the Soviet Union. The Soviet Union is vitally interested in keeping the United Nations Armed Force as weak as possible with regard to itself. The failure of the Military Staff Committee, charged by the Security Council with working out plans for the United Nations Armed Force, to reach agreement can be directly assigned to this politico-military situation and the political conflict between the United States and the Soviet Union underlying it.

The conflict between status quo and imperialism has been posed here in terms of the ratio according to which the United Nations Armed Force should be composed. The United States has tried to strengthen the forces of the status quo within the United Nations Armed Force by advocating that the United Nations Armed Force be composed of contingents proportionate to the armed strength of the member states. The Soviet Union, intent upon weakening the forces of the status quo and upon whittling down the preponderance of the United States in those weapons particularly dangerous to itself, has defended the principle of the equality of contributions to the United

## *Politics among Nations*

Nations Armed Force, regardless of the proportionate armed strength of the contributing states.<sup>7</sup>

Thus it is extremely unlikely that under present political conditions an international police force of the kind envisaged in Article 43 of the Charter of the United Nations can be formed at all. If, however, attempts at forming one should be successful, one of two things is likely to happen. Either the international police force will fail, torn apart by clashing national loyalties, or it will be a factor in a general war with the existing status quo as its stake.

An international police force in a society of sovereign states is a contradiction in terms. It is in the larger context of the world state that we will meet this problem again. The problem of an international police force, to be solved at all, must be solved within the framework of a world society which commands the ultimate secular loyalty of its individual members and has developed a conception of justice by which the individual nations composing it are willing to test the legitimacy of their individual claims.

---

<sup>7</sup> *U. N. doc. S/P.V. 138, 139; S/336.*

## CHAPTER XXIII

# *Judicial Settlement*

### I. THE NATURE OF THE JUDICIAL FUNCTION

The existence of conflicts among nations makes the realization of international peace through disarmament, collective security, and an international police force impossible. Nation A wants something of nation B which nation B is not willing to concede. In consequence, an armed contest between A and B is always possible. If there were a way, acceptable to A and B, of settling that conflict peaceably, it would make war superfluous as the supreme arbiter of conflicts among nations. And here again the analogy with domestic society is tempting.

In primitive societies individuals will often settle their conflicting claims through fighting. They will abstain from seeking a decision by violent means only when in the appeal to the authoritative decision of impartial judges they find a substitute for their appeal to arms. It seems obvious to conclude that, if such impartial judges were only available for the authoritative decision of international disputes, the main cause of war would be eliminated.

Such was indeed the conclusion many humanitarians and statesmen have drawn with increasing frequency and intensity since the middle of the nineteenth century. Toward the end of that century the so-called Arbitration Movement, whose main tenet was the compulsory settlement of all international disputes by international tribunals, could boast considerable mass support and enthusiastic loyalties. Its public influence was comparable to that of the mass movements which later pinned their hopes on the League of Nations, the United Nations, and a world state. We have already traced the history of the unsuccessful attempts to establish compulsory jurisdiction of international courts for the purpose of settling peacefully international disputes which otherwise might lead to war.<sup>1</sup> It remains for us now to examine the reasons for the failure of most of the nations, particularly the major nations, to accept the compulsory jurisdiction of international courts. It is not the stupidity or wickedness of statesmen or nations which must be held responsible for this failure, but the nature of international politics and of the society within which it operates.

---

<sup>1</sup> See above, pp. 220 ff.

## *Politics among Nations*

The analogy between the pacifying influence of domestic courts and the anticipated similar effect of international courts is mistaken on three grounds.

Courts decide disputes on the basis of the law as it is. The law as it is provides the common ground on which the plaintiff and the defendant meet. Both claim that the law as it is supports their cause, that it is on their side, and they ask the court to decide the case on that ground. The disputes which they ask the court to decide—aside from questions of fact—concern the bearing of the existing law on their respective claims, differently interpreted by plaintiff and defendant.

Such is the fundamental issue with which courts, domestic and international, must deal, and such is the nature of virtually all cases with which international courts have actually dealt. But those are not the issues which set nation against nation in deadly conflict and entail the risk of war. What is at stake in those international conflicts which are rightly called "political" and which have caused all major wars is not what the law is, but what it ought to be. The issue is here not the interpretation of the existing law recognized as legitimate by both sides, at least for the purposes of the lawsuit, but the legitimacy of the existing law as over against the demand for change.

Everybody knew in 1938, to cite only a few recent examples, what the legal situation was with regard to Czechoslovakia. Nobody had any doubts in 1939 what international law said with regard to the status of Danzig and the German-Polish frontier. There is no disagreement today concerning the rules of international law which apply to the rights and the obligations of the Soviet Union and Turkey with reference to the Dardanelles. What was or is at issue in all these controversies evoking the spectre of war is not the application and interpretation of international law as it is, but the legitimacy of the existing legal order and the justification of the demand for its change. What Germany was opposed to in regard to Czechoslovakia, Danzig, and Poland, and what the Soviet Union opposes with respect to the Dardanelles is not a particular interpretation of international law concerning these matters, but the existing legal order as such. What Germany wanted and what the Soviet Union wants is a new legal order to replace the old. It is this demand which was resisted by Great Britain and France in the case of Germany, and the incompatibility between the demand for a new legal order and the defense of the old brought about the Second World War. And it is the same demand on the part of the Soviet Union and the resistance to it by the Western powers which poisons the international atmosphere today and entails the risk of war.

In political terms such clashes between the existing legal order and the demand for its change are but another manifestation of the antagonism between the status quo and imperialism. Any particular distribution of power, once it has reached some degree of stability, is hardened into a legal order. This legal order not only provides the new status quo with ideological disguises and moral justifications. It also surrounds the new status quo with a bulwark of legal safeguards, the violation of which will put into motion the enforcement mechanisms of the law. The function of the courts is to put the enforcement action into motion by determining whether the concrete case under consideration justifies such action according to the existing rules of law. Thus



any system of existing law is of necessity an ally of the status quo, and the courts cannot fail to be its custodians. This is so in the international sphere no less than on the domestic scene.

Whenever the issue is one of determination of rights or of accommodation of interests within the generally accepted framework of the status quo, the courts will find for the plaintiff or the defendant, as the case may be. Whenever the issue is one of preservation or fundamental change of the status quo, the answer of the courts is ready before a question is even asked: they must decide in favor of the existing status quo and refute the demand for change. The courts of France in 1790 could no more have abolished the feudalistic monarchy and transformed France into a middle-class republic than an international court in 1800 could have given Napoleon predominance over Europe. That an international court would have rendered judgment in 1938 for Czechoslovakia, in 1939 for Danzig and Poland, and in 1947 for Turkey, as against Germany and the Soviet Union respectively, nobody in either camp has ever doubted. Since it is in its essence the status quo couched in legal terms, existing law favors the status quo, and the courts can only apply the existing law to the case in hand.

To invoke international law and international courts in a crisis where not the determination of rights and the accommodation of interests within the status quo, but the very survival of the status quo is at stake, is a favorite device of status quo nations. International law and international courts are their natural allies. Imperialistic nations are inevitably opposed to the existing status quo and its legal order and will not think of submitting the controversy to the authoritative decision of an international court. For the court cannot grant their demands without destroying the very foundation on which its authority rests.

## 2. THE NATURE OF INTERNATIONAL CONFLICTS: TENSIONS AND DISPUTES

Not only will controversies seeking to change the status quo not be submitted to courts, they will generally not even be formulated in legal terms, the only terms of which courts can take cognizance. In September 1938, the real issue between Germany and Czechoslovakia was not the sovereignty over the Sudetenland, but the military and political domination of Central Europe. The dispute over the Sudetenland was only one symptom of this issue among several. Of these symptoms the outstanding were the dispute with Austria culminating in the annexation of Austria by Germany in March 1938, and the dispute with Czechoslovakia in March 1939, resulting in the establishment of a German protectorate over that country.

The one cause underlying all these symptoms was a conflict whose stakes were not the more or less territorial concessions and legal adjustments within the framework of a recognized status quo, but the survival of the status quo itself, the over-all distribution of power, the all or nothing of supremacy in Central Europe. The disputes symptomatic of the power conflict could be formulated in the legal terms of claims, counterclaims, and de-

## *Politics among Nations*

nials, and as such be admitted and rejected by a court of law. The underlying cause was incapable even of formulation in legal terms; for the legal order whose survival was threatened by the claim for change had no legal concepts to express that claim, let alone a legal remedy to satisfy it.

At the bottom of disputes which entail the risk of war, there is a tension between the desire to preserve the existing distribution of power and the desire to overthrow it. These conflicting desires, for reasons already discussed,<sup>2</sup> are rarely expressed in their own terms — terms of power — but in moral or legal terms. What the representatives of nations talk about are moral principles and legal claims. What their talk refers to are conflicts of power. We propose to refer to the unformulated conflicts of power as “tensions” and call the conflicts which are formulated in legal terms “disputes.” A discussion of the typical relations between tensions and disputes will make clear the function which international courts are able to fulfill for the preservation of international peace. Three such typical relations can be distinguished.

### *a) Pure Disputes*

Between two nations there is sometimes no tension at all, yet there are disputes. Or sometimes, despite the existence of a tension, the dispute has no relation to the tension. In this case we speak of “pure disputes.”

Let us suppose that the United States and the Soviet Union are involved in a dispute over the exchange rate between dollars and rubles for the diplomatic personnel of the two countries. Despite the tension which exists between the United States and the Soviet Union, it is conceivable that such a dispute be submitted by the two parties to an international court for authoritative decision. Pure disputes, then, are susceptible to judicial decision.

### *b) Disputes with the Substance of a Tension*

It is, however, possible that a relation exists between a tension and a dispute. Such a relation can be of two different kinds. The subject matter of the dispute may be identical with a certain segment of the subject matter of the tension. The tension may be compared to an iceberg, the main part of which is submerged while the top stands out above the surface of the ocean. That small segment of the tension can be defined in legal terms and made the subject of a dispute. We call this type “disputes with the substance of a tension.”

One of the main issues of the tension between the United States and the Soviet Union is the distribution of power in Europe. The Potsdam Agreement is a legal document which endeavored to settle the aspects of that issue connected with the occupation and administration of Germany by the Allies. The subject matter of the Potsdam Agreement, then, is identical with a segment of the issue which constitutes the subject matter of the tension between the United States and the Soviet Union. A dispute over the interpretation of the Potsdam Agreement has a direct bearing upon the over-all power relations between the United States and the Soviet Union. An interpretation favorable to one nation will add so much power to one side and deduct that much

<sup>2</sup> See above, Chapter V.

power from the other side since the issue is one upon which the power contest between the two countries has seized as one of its main stakes.

With reference to such a dispute, to accept beforehand the authoritative decision of an international court, whatever it might be, is tantamount to surrendering control over the outcome of the power contest itself. No nation, especially those opposed to the status quo, has been willing to go so far. Since a court of law cannot help being a defender of the status quo formulated in legal terms, its decision is most likely to support the interpretation of a legal document which favors the status quo. By doing this, however, the court may meet the point of the dispute, but it misses the point of the tension. With respect to the tension, the interpretation of a legal document, such as the Potsdam Agreement, is but a phase in a contest whose issue is not the interpretation of the law as it is, but the justice of its existence.

A court, the product and the mouthpiece of the law as it is, has no way of deciding the real issue of a dispute whose subject matter is also the subject matter of a tension. A court is, in a sense, a party to such a dispute. A court, identified as it is with the status quo and the law representing it, has no standard of judgment transcending the conflict between the defense of the status quo and the demand for change. It cannot settle that conflict. It can only take sides. In the guise of an impartial settlement of the real issue, a court is almost bound to decide the apparent issue in favor of the status quo. In this inability of a court to transcend the limitations of its origin and functions lies the real cause of its inability to decide between the relative merits of the status quo and a new distribution of power.

*c) Disputes Representing a Tension*

The other type of dispute which stands in relation to a tension is the most important in view of this discussion. We call disputes of this kind "disputes representing a tension." On the surface disputes of this kind resemble pure disputes. As a matter of fact, pure disputes often transform themselves into disputes representing a tension, and vice versa. The subject matter of such a dispute has no relation at all to the subject matter of the tension. It is in the representative and symbolic function alone that the relation between tension and dispute consists.

Let us consider again the example of a dispute between the United States and the Soviet Union concerning the exchange rate of dollars and rubles for the diplomatic representatives of both countries. This dispute, may, as we have seen, lack any relation to the tension which exists between the United States and the Soviet Union. Yet it may also be that the two countries, engaged as they are in a contest over the general distribution of power, will seize upon this dispute making it the concrete issue by which to test their respective strength.

The fundamental issue which separates the United States and the Soviet Union—the over-all distribution of power in the world—is for the moral and ideological reasons already mentioned incapable of rational formulation in terms of claims and counterclaims. To use a term of modern psychology, it is "repressed." Representing, as it were, the unsettled foundation of the rela-

## *Politics among Nations*

tions between the two countries, the tension may communicate its turbulent agitation to any dispute of whatever kind and of whatever intrinsic importance. Once this has happened the dispute takes the place of the tension in the relations between the two countries. All the intensity of feeling and the uncompromising harshness of the rivalry for power, with which the nations consider the tension in peace and act upon it in war, is released into the dispute.

What in times of peace the nations cannot do with regard to the tension, they do now with regard to the dispute. The dispute becomes a test case in which claim and counterclaim represent and symbolize the respective power positions of the nations. Concessions are out of the question. For the claimant to concede, let us say, one-tenth of the object of the dispute would be tantamount to revealing a proportionate weakness in its over-all power position. For the other side to lose out altogether is unthinkable. The loss of the object of the dispute would be the symbolic equivalent of the loss of a decisive battle or of a war. It would signify defeat in the over-all struggle for power, in so far as that struggle is brought out on the level of disputes. Thus each nation will fight on a matter of procedure or prestige with uncompromising tenacity, as though the national existence itself were at stake. And in a symbolic sense it actually is at stake.

Rightly to be great,  
Is not to stir without great argument,  
But greatly to find quarrel in a straw  
When honor's at stake.<sup>8</sup>

Whenever a dispute stands in such a representative relation to a tension, a settlement in terms of the dispute becomes obviously impossible. This is true of a settlement by diplomatic negotiations which of necessity must proceed through the give-and-take of compromise. By the same token this is true of a settlement by authoritative judicial decision. What has been said in this respect of disputes with the subject matter of a tension applies to this category of disputes. Disputes representing a tension are looked upon by the nations concerned as though they were the tension itself. Similarly the judicial decision of such a dispute will be evaluated in terms of its bearing upon the tension. No nation, and especially no anti-status quo nation, for reasons already discussed, will take the risk of submitting a dispute of this kind, and through it the issue of the tension itself, to the authoritative decision of a court.

### 3. LIMITATIONS OF THE JUDICIAL FUNCTION

We arrive, then, at the conclusion that political disputes — disputes which stand in relation to a tension and in which, therefore, the over-all distribution of power between two nations is at stake — cannot be settled by judicial means. This conclusion, arrived at by way of analysis, is borne out by the actual behavior of states. We have already pointed to the extreme care with which states are wont to define and qualify their obligation to submit dis-

<sup>8</sup> *Hamlet*, Act. IV, Scene IV, lines 56 ff.

putes to international courts.<sup>4</sup> They do this in order to retain the ultimate control over the kind of settlement to be applied to their disputes.

It is significant that the nations which have concluded arbitration treaties without any qualification, thus submitting all disputes of any kind to the judicial process, are those between whom conflicts over the over-all distribution of power and, hence, political disputes are virtually impossible. Such treaties have been concluded, for instance, between Colombia and El Salvador, Peru and Bolivia, Denmark and The Netherlands, Denmark and Italy, Denmark and Portugal, The Netherlands and China, The Netherlands and Italy, Austria and Hungary, France and Luxembourg, Belgium and Sweden, Italy and Switzerland. No two states which had the slightest reason to anticipate the possibility of a political conflict with one another in the not too distant future have entered into legal obligations not allowing either side to exempt political disputes from judicial settlement.

Furthermore, among the twenty decisions rendered by the Permanent Court of Arbitration, there is none which can be called political in the sense in which we are using the term. Among the thirty judgments and twenty-seven advisory opinions rendered by the Permanent Court of International Justice,<sup>5</sup> there is one which can be called political: the advisory opinion in the case of the Austro-German Customs Union. We have already pointed to the fact that the jurisdiction of the Court in this case was based upon Article 14 of the Covenant of the League of Nations authorizing the Council of the League to request advisory opinions from the Court.<sup>6</sup> Being advisory, the opinion did not bind the Council, but left it free to take whatever measures it saw fit in the light of its own legal and political evaluation of the case. It may be added here that the Council of the League of Nations in this case acted as an organ of the status quo. That the Council should play such a role was inevitable in view both of its composition and the function it was supposed to fulfill as the political executive of the League of Nations.

This request for an advisory opinion drew the Court into a confusion which led to the greatest intellectual debacle in the history of that judicial agency. The fact that there were four different opinions and that out of fifteen judges seven felt the need to identify themselves with the two concurring opinions and seven signed a dissenting opinion illustrates the extent of the confusion. The measure of the intellectual debacle can only be conveyed by a perusal of the opinions themselves. The inability of so highly competent a tribunal to cope adequately with the case of the Austro-German Customs Union was the inevitable result of the nature of the case.

With the proposed Customs Union, Germany and Austria challenged the status quo of 1919. The Permanent Court of International Justice was intellectually prepared to deal with any case arising within the framework of the existing status quo. The legal order of that status quo furnished it with the intellectual instruments to perform that task. Confronted with a challenge to that status quo, the Court was thrown off balance by its inability to find grounds above the contentions of the parties from which to judge the claims

<sup>4</sup> See above, pp. 221 ff.

<sup>5</sup> Different authors use different figures. We follow Oppenheim-Lauterpacht, *loc. cit.*, II, 674.

<sup>6</sup> See above, p. 224.

## *Politics among Nations*

and counterclaims. Being an organ of the status quo and performing functions which had to take the legitimacy of that status quo for granted, the Court found itself faced with a task which no court of law is capable of performing. to pass judgment on the legitimacy of the status quo itself by finding upon the legality of the projected Austro-German Customs Union.

Judge Anzilotti, in his brilliant and profound concurring opinion, put his finger on the essentially political problem which faced the Court and which it could not meet with the judicial means at its disposal. "Everything points to the fact that the answer depends upon considerations which are for the most part, if not entirely, of a political and economic kind. It may therefore be asked whether the Council really wished to obtain the Court's opinion on this aspect of the question and whether the Court ought to deal with it. . . . I grant that the Court may refuse to give an opinion which would compel it to depart from the essential rules governing its activity as a tribunal. . . ." <sup>7</sup> The Court did not refuse to give an opinion and, by trying to decide a conflict between the status quo and the desire for change, departed "from the essential rules governing its activity as a tribunal."

Finally, perhaps the most impressive empirical evidence for the analysis offered above is presented by the relations between the United States and the Soviet Union as they have developed since the end of the Second World War. It has been a matter of much comment that it is extremely difficult to define the fundamental issue which separates the United States and the Soviet Union. It is not Germany, nor Austria, nor Trieste, nor Greece, nor Turkey, nor Iran, nor Korea, nor China. Nor is it the sum of all these single issues. Nor can the fundamental issue be defined in terms of the conflict between two antagonistic philosophies and systems of government; for that conflict existed for twenty-five years without having the kind of repercussions on the international scene which we are witnessing today. The issues mentioned, either singly or combined, cannot account for the depth and the bitterness of the conflicts which engulf the United States and the Soviet Union wherever they meet, and for the stalemates which attend their every effort at settling those conflicts by peaceful means.

The existence of a tension embracing the whole globe can explain these peculiarities of the individual conflicts. That tension provides the lifeblood which pulsates in all the issues, small and large, standing between the United States and the Soviet Union, and imparts to them the same color, the same temperature, and the same peculiarities. It is indeed the fundamental issue of which all the single issues mentioned above are but ramifications or symbolic representatives. The discord between the United States and the Soviet Union over the distribution of power throughout the world precludes the solution of any single dispute pending between the two countries on its own terms. By the same token it precludes also the judicial settlement of such disputes.

Through analytical and empirical considerations, we have arrived at the conclusion that the disputes which are most likely to lead to war cannot be settled by judicial means. Their real issue, being the ramifications or symbolic representatives of a tension, is the maintenance of the status quo vs. its

<sup>7</sup> *R. C. I. J. Series A/B, No. 41, pp. 68, 69.*

### *Judicial Settlement*

overthrow. No court, domestic or international, is equipped to settle this issue. The consideration of the question as to how this issue is normally settled in the domestic sphere shows from yet another angle the fallacy of the analogy between the pacifying function of domestic and international courts.

## CHAPTER XXIV

# *Peaceful Change*

### I. PEACEFUL CHANGE WITHIN THE STATE

Tensions are a universal phenomenon of social life. They occur in the domestic no less than in the international sphere. In the domestic sphere, too, a given status quo is stabilized and perpetuated in a legal system. Social forces, hostile to this status quo, arise and try to overthrow it by changing the legal system. It is not the courts which decide that issue. The courts cannot help but act as agents of the status quo. In the struggle between the desire for change and the status quo the cause of change is upheld, if at all, by legislatures and, sometimes, by the executive power. Thus the tension between the status quo and the demand for change frequently resolves itself in domestic affairs into a conflict between the courts as the defenders of the status quo and the legislature as the champion of change.

This is true of many of the great controversies of modern history in which tensions manifested themselves. Thus the tension between the status quo of feudalism and the desire for change of the middle classes manifested itself in the rivalry between courts and Parliament in nineteenth-century Britain. In the intellectual realm this rivalry was foreshadowed in the polemic of Bentham, the apostle of reform through legislation, against Blackstone, the conservative defender of the common law and of its courts. A similar conflict arose in the United States in the first decades of the twentieth century when the status quo of laissez faire was protected by the courts against social and regulatory legislation. In both cases change won out, and the courts became the defenders of the new status quo.

Three factors made this peaceful transformation possible: (1) the ability of public opinion to express itself freely, (2) the ability of social and political institutions to absorb the pressure of public opinion, and (3) the ability of the state to protect the new status quo against violent change.

In both nineteenth-century England and twentieth-century America, public opinion expressed the desire for change through the spoken and printed word, through organized efforts and spontaneous reactions. Under the impact of these expressions, the moral climate of the community changed, putting the stamp of its approval upon the desire for change and depreciating the



## *Peaceful Change*

status quo and its defenders. No social or political agency could escape the all-pervading influence of this moral climate. In that intangible transformation of moral valuations we find the most potent force promoting the transformation of the status quo.

Public opinion not only had the opportunity to voice its desire for change; it also had the chance to compete with the defenders of the status quo in fashioning legal rules which would either support or change the status quo. This competition took the form either of elections to legislative bodies or of campaigns for certain pieces of legislation within these bodies. Thus the social forces demanding change were channeled into parliamentary institutions. There they met their opponents in a peaceful contest which would decide the winner according to the objective standards of the majority vote accepted by all beforehand. In this way the status quo was transformed on those two spectacular occasions without disrupting the continuity of the legal processes and without endangering the peace and order of society.

Finally, the authority and power of the state stands ready to enforce whatever legal order has emerged from the contest between social groups and political factions, provided that legal order conforms to the minimum requirements of the moral consensus upon which the whole structure of public institutions is founded. This readiness of the state and its unchallengeable superiority to any possible opposition not only discourage minority groups from opposing a given status quo by violent means, but also impose two important restraints upon public opinion. They restrain the important sections of public opinion from advancing demands so extreme as to be unacceptable to any other important section and, hence, to be enforceable by the state only at the risk of armed resistance. They act as powerful incentives for compromise in legislative bodies which are aware of the power of the state and of its limitations. For the state can and will enforce those laws which do not flout the minimum requirements of the moral order of the state itself. But the state cannot try to enforce laws which contravene those minimum requirements without risking the disintegration of its own fabric in civil war.

Such is the normal process of social change in a free society. It is apparent that this process is not performed by any particular agency discharging its regular duties. Social forces, elevating their needs into principles of justice, capture public opinion. It is the all-pervading influence of public opinion which determines the moral valuations and legal decisions of legislative agencies, as it does in the long run of courts and of the executive power. Legislative, judicial, and executive agencies are instruments of public opinion. They all fulfill the same function for public opinion: to provide peaceful and orderly channels for the presentation of its demands and for its confrontation with others, for their evaluation in the light of generally shared principles of justice, and for the transformation into reality of those that have been recognized as legitimate.

What the legislative bodies contribute to this process of change is primarily in the nature of a forum for the public presentation of divergent views and of the ratification of a choice already made by unorganized society. It would be naive to believe that the issue between the status quo and change, whenever it arises, needs only to be submitted to a legislative body which will

## *Politics among Nations*

settle the issue either by passing or refusing to pass a law. In this process of peaceful change legislatures play an indispensable yet secondary role.

Whatever contribution the courts may make to the process of peaceful change from one status quo to another is governed by the moral climate which pervades the halls of justice no less than the chambers of Congress, the White House, and the homes of ordinary citizens. Since, as we have seen, the courts can only apply the law as it is, they cannot help but be instruments of the status quo. Once the legislature has passed a new law embodying a new status quo, however, the courts can accelerate and smooth the transition from one status quo to another, or they can retard it and endanger its peaceful and orderly progress. In other words, the courts can resist inevitable change or they can contribute to its peaceful and orderly realization. Which of these roles the courts will play depends upon the strength and single-mindedness of public opinion as well as upon the receptiveness of the courts to that public opinion.

The executive branch of the government in a democracy can influence and lead public opinion and bring its pressure to bear upon the other branches of the government. It cannot bring about major changes through its own independent efforts. Its main function consists in enforcing the decisions which the other branches have made. In a dictatorship, however, all functions of the government are merged in the hands of the executive who decides and enforces at the same time. Yet it would be a mistake to believe that the dictator can decide as he sees fit regardless of public opinion. He is indeed able to manipulate public opinion through effective use of the channels of communications over which he holds monopolistic control. But for his propaganda to be effective it must not be too much at variance with the direct experiences of his subjects in their daily lives. The dictator, then, must either square these experiences with his propaganda or else adapt his propaganda to these experiences. In any case even the dictator is exposed to pressures of public opinion which he can neither completely mold nor ignore.

Such are, in sketchy outline, the processes of peaceful change on the domestic scene. They make it possible for tensions to manifest themselves in public controversies, election campaigns, parliamentary debates, and governmental crises, instead of in violent conflagrations. If, however, those processes do not operate or operate badly, the domestic situation which then will arise resembles the conditions which exist on the international scene. Demands for change, unable to assert themselves in the competition of the market place, in electoral and legislative contests, go, as it were, underground. The controversy between the status quo and the demand for change becomes a tension with effects upon disputes similar to those which we have recognized in the international field. Domestic society, then, will enter a pre-revolutionary or revolutionary stage. The groups of the population identified respectively with the status quo and the demand for change will oppose each other like two armed camps which, unable to appeal to the arbitrament of the majority vote or even to formulate their positions in terms common to both, seek a decision in economic or military war.

Whether such a situation actually degenerates into revolution and civil war depends on the distribution of power within domestic society. We have

already pointed out in another context that the modern technology of war and communications makes popular revolutions extremely unlikely.<sup>1</sup> The odds are very much in favor of violent changes in form of coups d'état. Instead of one fraction of the population rising against the government supported by another fraction of the population, it is more likely that one segment of the governmental machinery, especially of the armed forces, will try to gain control over all of the government.

What is important for our present discussion is to recognize that it is not the domestic courts which peacefully settle disputes that otherwise might lead to revolution and civil war. When in the Dred Scott case the issue of the territorial extension of slavery was before the Supreme Court of the United States, the Court decided in favor of the status quo. Yet that decision settled nothing. No court of law could have settled what was at stake in the Dred Scott case. Even society as a whole was unable to settle the conflict between the status quo and the desire for change by peaceful means. For that conflict not only challenged the existing distribution of power between North and South, but in the issues of slavery and the relations between the federal and state governments it also reopened the question as to the content of the moral consensus upon which the political structure of the United States was built. That question was addressed not to a court or a legislature, but to society as a whole. And American society gave two incompatible answers. It was those answers which made the conflict "irrepressible."

The vital function of peaceful change within the state is performed not by any particular agency acting in isolation, but by domestic society as an integrated whole. The moral consensus of society, supported by the authority and material power of the government, will avail itself of all social and political agencies to bring about a state of affairs in conformity with its conception of justice. For this process of peaceful change, legislative bodies play a particularly important role if, as in democratic societies, they are free agents. But legislatures, too, are only the agents of society as a whole. Without society's support their laws are impotent to bring about the desired change. The history of legislation is strewn with laws, such as the antitrust laws, which, while enacted by the legislature and remaining on the statute books, have failed to achieve their purpose because the moral consensus of society does not support them. Thus legislative bodies are no more capable than courts of peacefully changing an old status quo into a new one by merely performing their technical functions. In other words, to legislate suffices no more than to hand down a judicial opinion when society is confronted with its supreme challenge: to change the distribution of power within society without jeopardizing the orderly and peaceful processes upon which the welfare of society depends.

## 2. PEACEFUL CHANGE IN INTERNATIONAL AFFAIRS

An important lesson can be learned from the analogy between the legal processes of domestic and international societies. But it is not the lesson which

<sup>1</sup> See above, pp. 299 ff.

## *Politics among Nations*

the advocates of the judicial settlement of international disputes have drawn. Domestic courts do not and cannot fulfill the function which advocates of judicial settlement ascribe to them. They do not and cannot peacefully settle disputes which otherwise would lead to violent conflagrations. The forces and institutions, however, which fulfill this function for domestic society do not exist at all on the international scene.

As we have seen,<sup>2</sup> there is no longer a moral consensus among nations from which quarreling nations could receive a common standard of justice for the settlement of their disputes. Since the end of the Second World War this moral cleavage has become so deep and the tension between the United States and the Soviet Union so all-permeating that even disputes arising within the framework of the existing status quo are no longer capable of judicial settlement. Thus the failure to submit disputes to the International Court of Justice, in contrast to the extensive activities of its predecessor, takes on peculiar significance. This failure is a symptom of the disintegration of international society. This disintegration has now gone so far as to preclude international courts from performing even the normal functions which they have successfully discharged in the past.

The same lack of a moral consensus has prevented the realization of the provisions, found in many arbitration treaties and also in the Statute of the International Court of Justice, which under certain conditions allow international courts to decide not according to strict international law, but *ex aequo et bono*, that is, according to the general principles of equity and justice. Provisions of this kind are sound in that they recognize the existence of disputes not susceptible to judicial settlement on the basis of the existing rules of international law. Such provisions are, however, unsound in that they assume that the problem posed by the latter category of disputes can be solved simply by authorizing courts to depart from the existing rules of international law and to invoke some general principles of equity and justice. International courts can invoke such principles only if these principles exist. They cannot invent them or refer to them as to a *deus ex machina*, standing ready to intervene whenever an international court is caught between the status quo and the desire for change. International society is in want of generally accepted standards of justice through which the respective merits of the defense of, and the attack upon, the status quo could be determined. To empower a court to use such standards is of little help if the standards to be used do not exist.

International society also lacks legislative bodies which could fulfill the functions in the process of peaceful change similar to the functions which legislative agencies perform for domestic society. Article 19 of the Covenant of the League of Nations and Article 14 of the Charter of United Nations have endeavored to supply an instrumentality for peaceful change. Article 19 of the Covenant reads: "The Assembly may from time to time advise the reconsideration by Members of the League of treaties which have become inapplicable and the consideration of international conditions whose continuance might endanger the peace of the world." Article 14 of the Charter refers in general to "the peaceful adjustment of any situation, re-

<sup>2</sup> See above, pp. 181 ff.

ardless of origin, which it [the General Assembly] deems likely to impair the general welfare or friendly relations among nations."

a) *Article 19 of the Covenant of the League of Nations*

Concerning Article 19 of the Covenant of the League of Nations, Professor Frederick S. Dunn has rightly stated that it "has been a dead letter from the beginning."<sup>3</sup> Article 19 was formally invoked only once, by Bolivia against Chile in 1920. In view of an unfavorable report by a committee of jurists appointed by the Assembly, Bolivia retracted its request and up to 1929 refused to participate any further in the work of the League.

In its report the committee of jurists made two important points: one obvious, the other seriously limiting the applicability of Article 19. The report declared—what the text of Article 19 obviously suggests—that the Assembly had no authority to modify treaties with binding effect, that such modification was within the exclusive competence of the contracting parties, and that it could only give advice to the members of the League. The condition for giving such advice with regard to treaties, however, was their inapplicability. And the committee defined inapplicability of treaties as the intervention of such radical material and moral changes "that their application has ceased to be reasonably possible."<sup>4</sup> A situation where the perpetuation of the status quo would be so obviously outrageous as to meet these requirements would be rare indeed.

Let us, however, assume that the Assembly had advised the members concerned to reconsider a treaty or to consider a situation which threatened the peace. The parties were free to accept or reject this advice. If they accepted the advice voluntarily, it was safe to surmise that the interests at stake were not vital and that any kind of outside pressure, encouragement, or face-saving device would probably have induced them to agree on reconsideration of the treaty or consideration of the situation. Yet consideration does not mean agreement. The parties concerned might have considered the treaty or the situation and thereby have complied with the advice of the Assembly. They might still not have agreed upon a solution, and Article 19 vested no authority in the Assembly to impose a solution upon them.

It is an open question whether the Assembly could have given advice in pursuance of Article 19 only by unanimous vote or whether a majority vote would have been sufficient. If one assumes that unanimity was required, the Assembly would have been unable to give advice if even one state was opposed. And the state whose interests would have been adversely affected by a change in the status quo would most likely have been opposed. If, on the other hand, the parties concerned were already agreed upon reconsideration of the status quo, they were not in need of advice to that effect, and the proceedings by virtue of Article 19 were without purpose.

If one assumes, however, that only a majority vote was required, the situation was similar to the one which we found to vitiate the practical opera-

---

<sup>3</sup> *Peaceful Change* (New York: Council on Foreign Relations, 1937), p. 111.

<sup>4</sup> *Journal of the Second Assembly of the League of Nations*, 1921, p. 218.

## *Politics among Nations*

tion of collective security.<sup>5</sup> In any situation where the perpetuation of the status quo is at stake, it is probable that the community of nations will be divided into two hostile camps. One group will favor the perpetuation of the status quo, the other will demand its overthrow. Which group has a numerical majority is obviously an irrelevant question. What counts in a society of sovereign nations is only where the preponderance of power resides. A minority of great powers will assuredly disregard the advice of a majority of weak and medium powers; the advice of a majority ready to use overwhelming power will be heeded by the minority. Actually, however, it is much more likely that two camps of not too disproportionate power will oppose each other. In such a contingency the issue would not have been decided by the advice of the anti-status quo nations which might have had a majority in the Assembly of the League of Nations.

### *b) The Palestine Resolution of the General Assembly of the United Nations*

These considerations, merely speculative with respect to Article 19 of the Covenant of the League of Nations, have been tested by the actual operation of Article 14 of the Charter of the United Nations. Article 18, paragraph 2, of the Charter provides that the General Assembly of the United Nations can make recommendations by virtue of Article 14 by a two-thirds majority of the members present and voting. While broader and less specific in its wording than Article 19 of the Covenant, Article 14 is intended to fulfill for the United Nations the same function which Article 19 was supposed to perform for the League: to open a legal avenue for peaceful change. The General Assembly of the United Nations has availed itself of this power to make recommendations with remarkable frequency. Within the span of little more than a year it has made recommendations with regard to the treatment of the Indians in the Union of South Africa, the situations in Greece and Korea, and the problems of Spain and Palestine.

With respect to all these situations, except the last mentioned, however, the recommendations of the General Assembly had either no relevance for the problem of peaceful change or aimed at the maintenance of the status quo through the preservation or restoration of peace. Its recommendations concerning the problem of Palestine are of a different character. The resolution of the General Assembly of November 29, 1947, recommending the partition of Palestine, was a genuine attempt at peaceful change, the only one on record undertaken by an international organization.<sup>6</sup> Its goal was the peaceful change of the status quo in the Near East, a redistribution of power in a particular region of the world. The status quo with which the General Assembly had to deal, stripped to its essentials, was marked by three facts: (1) the predominance of Great Britain within the territory of Palestine, (2) the opposition of the Arab and Jewish populations in Palestine to that predominance, and (3) the struggle between the Arabs and

<sup>5</sup> See above, pp. 331 ff.

<sup>6</sup> The partition of Upper Silesia by the League of Nations in 1921 is not a case in point. The League acted in this case under the authority of the Treaty of Versailles, and the partition was part of the peace settlement imposed by the victors.

## *Peaceful Change*

Jews for predominance over the country. Under the scheme envisaged by the General Assembly, the predominance of Great Britain would be terminated, and the territory of Palestine would be divided into three parts, one under the sovereignty of the Arabs, another under the sovereignty of the Jews, and a third under the sovereignty of the United Nations.

There was general agreement concerning the termination of British rule. Yet the resolution for recommending partition was passed by a vote of thirty-three to thirteen with ten countries abstaining. Afghanistan, Cuba, Egypt, Greece, India, Iran, Iraq, Lebanon, Pakistan, Saudi Arabia, Syria, Turkey, and Yemen voted against the resolution. Argentina, Chile, China, Colombia, El Salvador, Ethiopia, Honduras, Mexico, Great Britain, and Yugoslavia abstained from voting. It is worthy of note that none of the countries directly affected by the recommended redistribution of power voted in favor of the resolution; they either abstained (Great Britain) or voted against the resolution (the Arab countries).

The words and actions of the Arab countries left no doubt that the Arabs inside and outside Palestine would oppose partition by force of arms. Great Britain declared in advance of the vote and repeatedly since that she would not assist in the execution of any plan which was not acceptable to Arabs and Jews alike. In view of the Arab opposition, this was tantamount to saying that Great Britain would not co-operate at all in carrying out the recommendations of the General Assembly.

Great Britain has, however, gone beyond mere non-cooperation. It has done what it was able, short of taking up arms, to make the execution of the recommendations of the General Assembly impossible. To that end Great Britain continued to send arms to the Arab states adjacent to Palestine, while at the same time preventing arms from reaching Palestine. Furthermore, it refused to recognize the right of the Palestinian Jews to arm themselves and to establish a military organization during the transition period from British rule to actual partition. Finally, Great Britain did not allow the General Assembly to make on-the-spot preparations for an orderly and peaceful transition and to establish provisional agencies of government before the actual end of British rule. All these measures were bound to favor the Arabs and to work to the disadvantage of the Jews. If it had been the avowed purpose of the British government to make the change from British to the new rule chaotic and violent instead of peaceful and orderly and to assure the victory of the Arabs in the ensuing civil war, it is hard to see what more Great Britain could have done.

Faced with the prospect of armed resistance, the General Assembly in its resolution of November 29, 1947, requested the Security Council to "determine as a threat to peace, breach of the peace or act of aggression, in accordance with Article 39 of the Charter, any attempt to alter by force the settlement envisaged by this resolution."<sup>7</sup>

The General Assembly further requested the Security Council, in case the latter made such a determination, to take "measures, under Articles 39 and 41 of the Charter, to empower the United Nations Commission, as provided

---

<sup>7</sup> U. N. doc. A/516.

## *Politics among Nations*

in this resolution, to exercise in Palestine the functions" of a provisional government.

These requests amounted to a dual admission which our analysis of Article 19 of the Covenant of the League of Nations has shown to be correct. On the one hand, a recommendation to change the status quo, which is acceptable to all parties concerned, is superfluous; its acceptance shows that whatever disagreements there might have been among the parties did not affect the over-all distribution of power among them, but affected only adjustments within an over-all distribution of power upon which all parties concerned were agreed. On the other hand, a recommendation to change the status quo, which is opposed by one of the parties concerned, will either remain a dead letter or must be enforced. Hence, the recommendation, to be effective, must become a decision backed by force. It was the purpose of the requests of the General Assembly that this transformation of recommendation into decision be brought about by the only agency of the United Nations which the Charter has given the power to make decisions to use force: the Security Council.

In the discussions and decisions of the Security Council concerning these requests, the dilemma of peaceful change in a society of sovereign nations came to the fore. The members of the Security Council, some of whom are identical with the leading members of the General Assembly, now no longer dealt with a mere recommendation by which nobody was bound and which, therefore, everybody could disregard at his discretion. The members of the Security Council had to make a decision, binding upon themselves and upon the parties concerned. That decision could not fail to commit the interests and the power of at least some of the members of the Security Council.

At this point the national interests of individual nations reasserted themselves against, and prevailed over, the common good as defined by the resolution of the General Assembly of November 29, 1947, in terms of the need for peaceful change. Aside from Syria as representative of the Arab states in the Security Council and Great Britain, a number of other nations, among them the United States, believed that enforced partition was against their national interests. No member of the Security Council felt that its national interests demanded enforced partition. Thus enforced partition and with it peaceful partition was dead when the Security Council met on February 24, 1948, to act upon the resolution of the General Assembly of November 29, 1947.

The Security Council's task, then, was to give the corpse a decent burial. The United States assumed charge of the funeral arrangements. Peaceful partition was carried to its grave on a hearse which was drawn by four horses belonging to the stable of Legal Fiction and which were named Recommendation, Collective-Decision, Threat-to-the-Peace, and Committee. The examination of the anatomy of the horses will show why peaceful partition was bound to die.

In the Security Council the United States made four points which amounted to four "No's" with regard to peaceful partition: (1) it was still in favor of partition as recommended by the General Assembly; (2) it would abide by whatever the Security Council would decide; (3) by virtue of the



provisions of the Charter, the Security Council had no authority to enforce partition, but only authority to use force in order to meet a threat to the peace; (4) a committee should decide whether a threat to the peace actually existed.<sup>8</sup>

Point (1) as a mere reference to the resolution of November 29, 1947, is meaningless; for the issue before the Security Council was no longer one of recommendation, but of decision. With the recommendations having been rejected by two of the three parties concerned, the choice was no longer between recommendation and decision, but between decision and nothing.

Point (2) is based upon an implicit distinction between the interests and preferences of the United States and the interests and preferences of the United Nations as they manifest themselves in the collective body of the Security Council. In view of the veto and of the predominant position of the United States within the Security Council, the distinction is purely fictitious. No decision of the Security Council can conceivably contradict what the United States considers its interests. If the Security Council should ever render such a decision the United States would veto it. The Security Council, however, has never done so and is not likely ever to do so because of the controlling influence which the United States is able to exert, if need be, over the great majority of the members of the Security Council. A decision by the Security Council, reached under the leadership of the United States, can be vetoed by a permanent member. But without the leadership of the United States there cannot even be a decision to be vetoed. In this sense, then, it can be said that for all practical purposes, and especially when vital interests of the United States are at stake, the United States is the Security Council. For the United States to say "We shall do what the Security Council tells us to," without saying at the same time what the Security Council should do, amounts to saying "We shall do nothing."

Point (3) is the heart of the American position. It constitutes a radical departure from the stand taken by the resolution of November 29, 1947, on the initiative and with the support of the United States. The United States, speaking through the resolution, identified a threat to the peace, which establishes the right and the duty of the Security Council to act under Article 39 of the Charter, with "any attempt to alter by force the settlement envisaged by this resolution." The United States, speaking as a member of the Security Council, distinguished between armed resistance to partition and a threat to the peace.

The United States furthermore distinguished between two different kinds of threats to the peace: external aggression against Palestine and internal disorders threatening international peace. According to the American interpretation, Article 39 of the Charter empowers the Security Council to use force against a threat to the peace, but not to enforce partition. Any attempt to prevent partition by force from within Palestine is, then, per se not a threat to the peace justifying the enforcement action of the Security Council. It might become such a threat only if it would tend to engulf other countries in war.

---

<sup>8</sup> *Department of State Bulletin*, March 7, 1948 (Vol. XVIII, No. 453), pp. 294 ff.

## *Politics among Nations*

Not only were these distinctions the reverse of what the view of the United States had been three months before. The distinctions erected also a practically insurmountable legal barrier against any enforcement action on the part of the Security Council. Partition being the issue at stake, whatever threat to the peace there might be was bound to take the form of armed resistance to partition and, hence, to be outside the coercive authority of the Security Council, so long as armed resistance operated within Palestine. It was, however, obvious that the Arab states, as long as they could do so successfully, would resist partition not by invasion, but by infiltration. The penchant of the Arabs for guerrilla warfare made this military technique likely. The contiguity of the Arab territories of Palestine with the neighboring Arab states made it inevitable. It was, therefore, very unlikely that, without the connivance of one or the other of the great powers, the conflict would openly spread beyond the borders of Palestine, thus threatening international peace as defined by the United States. To say, then, that the Security Council can enforce partition only in case of a threat to international peace amounts to saying that the Security Council cannot enforce partition at all.

Under such circumstances and with these distinctions as its frame of reference, the Commission provided for by point (4) would have had no difficulty in finding that the armed conflict was a purely local matter and, hence, did not constitute a threat to the peace. When on March 19, 1948, the United States, through its representative to the Security Council, asked the United Nations to abandon the attempt to bring about peaceful change through partition, it only made explicit a decision which was already implicit in the declaration of February 24.

The fiasco of peaceful change by virtue of Article 14 of the Charter of the United Nations in the case of Palestine demonstrates empirically what we have tried to show through the analysis of Article 19 of the Covenant of the League of Nations. If the parties concerned agree, a recommendation on the part of an international body is superfluous. If the parties concerned do not agree, peaceful change is possible only under the ideal conditions of collective security where overwhelming force is marshalled against the dissenting party. Since, as we have seen, the realization of these conditions is extremely improbable, the mechanisms for peaceful change provided by modern international organizations are bound to be unworkable. If they are put into operation at all there will either be no change, or what change there is will not be peaceful. That is to say: Either the recommendations for change will not be enforced, or war between the nations favoring, and those opposing, change will decide the issue. This cannot be otherwise in a society of sovereign nations. For sovereign nations are moved to action by what they regard as their national interests rather than by the allegiance to a common good which, as a common standard of justice, does not exist in the society of nations.

## CHAPTER XXV

# *International Government*

The remedies for international anarchy and war discussed thus far are all specific remedies. They attack a particular problem in which the lack of international order and the tendency toward war are manifest and they endeavor to solve the general problem of international order and peace through a solution of the particular problem. International government owes its existence to the recognition that peace and order are the products not of a specific device meeting a particular problem, but of the common bond which unites an integrated society under a common authority and a common conception of justice. How to found such an authority in a society of sovereign states and to create such a conception of justice is, then, the task which any attempt at international government must try to solve.

Each of the three world wars of the last century and a half was followed by an attempt to establish an international government. The total failure to keep international order and peace called forth an over-all effort to make international order and peace secure. The Holy Alliance followed the Napoleonic Wars; the League of Nations, the First World War; the United Nations, the Second World War. With regard to each of these attempts at international government three questions must be asked: (1) Where is the authority to govern vested, or who is to govern? (2) By what principle of justice is the government to be guided, or what is the conception of the common good to be realized by the government? (3) To what extent has the government been able to maintain order and peace?

### I. THE HOLY ALLIANCE

#### *a) History*

The international government commonly called the Holy Alliance was based upon three treaties: the Treaty of Chaumont of March 9, 1814, the Quadruple Alliance signed at Paris on November 20, 1815, and the Treaty of the Holy Alliance of September 26, 1815. In the Treaty of Chaumont, Austria, Great Britain, Prussia, and Russia concluded an alliance for twenty years for the purpose of preventing the Napoleonic dynasty from returning to France and of guaranteeing the territorial settlement to be made at the end of the

## *Politics among Nations*

war against Napoleon. The Quadruple Alliance reaffirmed the provisions of the Treaty of Chaumont and in its Article VI laid down the principles of what is known as "congressional government" or "diplomacy by conference."<sup>1</sup>

In contrast with the Quadruple Alliance which presented, as it were, the constitutional law of the international government of the Holy Alliance, the Treaty of the Holy Alliance itself, from which the international government received its name, contained no principles of government at all. It proclaimed the adherence of all rulers to the principles of Christianity with God as the actual sovereign of the world. It is replete with phrases such as "reciprocal service," "unalterable good will," "mutual affection," "Christian charity," "indissoluble fraternity." Originally signed by the rulers of Austria, Prussia, and Russia, the Holy Alliance was adhered to by all European governments, with the exception of the Pope and the Sultan.<sup>2</sup> Obviously inspired by Czar Alexander I of Russia, it reaffirmed the moral unity of Europe and, as already pointed out, in that reaffirmation of a moral consensus among the nations lies one of the actual functions which the Treaty of the Holy Alliance fulfilled.

The Treaty of the Holy Alliance was of no significance for the actual operations of the international government which bore its name. Its principles were invoked from time to time by the Czar, affirmed in words and rejected in action by the other powers. Castlereagh, British Foreign Minister at the time of its conclusion, called it "a piece of sublime mysticism and nonsense," and the Austrian Chancellor Metternich made vulgar jokes at its expense. Yet it served as moral justification for the principles of justice which the three original signatories of the Treaty propounded and for the policies by which they endeavored to realize these principles. Thus the Treaty of the Holy Alliance also fulfilled an ideological function and became the symbol of this whole era of international relations.

In 1818, the four signatories of the Quadruple Alliance admitted France as a fifth member to take part in all further meetings which were to be held by virtue of Article VI of that treaty. In a circular signed in 1820 at the Congress of Troppau, Austria, Prussia, and Russia pledged themselves never to recognize the right of any people to circumscribe the power of their kings. This compact is known as the Neo-Holy Alliance. Castlereagh, in two dispatches of the same year, refused to have any part in policies whose purpose was to interfere by force in the internal affairs of other countries. His successor, Canning, maintained this principle at the Congress of Verona in 1822, the last of the congresses which Great Britain attended.

When the news of the failure of the Congress of Verona reached him, Canning, in a letter to Bagot of January 3, 1823, hailed the end of interna-

---

<sup>1</sup> Article VI reads as follows: "To assure and facilitate the execution of the present Treaty, and to consolidate the intimate relations which to-day unite the 4 Sovereigns for the good of the world, the High Contracting Parties have agreed to renew, at fixed periods, whether under the immediate auspices of the Sovereigns, or by their respective Ministers, reunions devoted to the great common interests and to the examination of the measures which, at any of these periods, shall be judged most salutary for the repose and prosperity of the peoples, and for the maintenance of the peace of the State."

<sup>2</sup> The British monarch, for constitutional reasons, could not formally adhere.

tional government by congresses and the beginning of a new era, as far as Great Britain was concerned, by invoking the religious principle of the Holy Alliance with a vengeance: "Every nation for itself, and God for us all!" International government by conference as a going concern did not survive the British defection. After two more abortive attempts, one with reference to the Spanish colonies, the other concerning Greece and Turkey, it came to an end in 1825.

The system of an over-all international government instituted by Article VI of the Quadruple Alliance of November 20, 1815, did not last even a decade. The lifetime of the system of ambassadorial conferences for the settlement of special problems was even shorter. It, too, was established by the Treaties of 1815 and consisted of three agencies: the ambassador to France of Austria, Great Britain, Prussia, and Russia dealing mainly with the problems growing out of the peace treaties with France, yet acting in a general way as the paramount executive organ of the Quadruple Alliance; the ambassadors of the great powers meeting in London to organize the abolition of the slave trade; and the ambassadorial conference at Frankfurt for the discussion of German problems. All these agencies had disappeared by 1818.

*b) Government by the Great Powers*

The international government of the Holy Alliance was government by the great powers. The distinction between great and small powers as a political fact pointing to the extreme differences in power among nations is of course one of the elemental experiences of international politics. As an institution of international politics and organization it sprang from the brains of Castlereagh and became the very foundation of the scheme adopted in 1815. It is true that the protocol of the Congress of Aix-la-Chapelle of November 15, 1818, providing for future meetings of the five great powers also stipulated "that in the case of these meetings having for their object affairs specially connected with the interests of the other States of Europe, they shall only take place in pursuance of a formal invitation on the part of such of those States as the said affairs may concern, and under the express reservation of their right of direct participation therein, either directly or by their Plenipotentiaries." Yet this stipulation remained without appreciable influence upon the policies of the Holy and, more particularly, of the Neo-Holy Alliance.

*c) Dual Meaning of the Status Quo*

To the question as to what principle of justice guided the Holy Alliance, the answer seems to be clear: the maintenance of peace on the basis of the status quo. This principle was never more clearly stated than in the declaration of the five great powers signed at Aix-la-Chapelle on November 15, 1818: "The object of this Union is as simple as it is great and salutary. It does not tend to any new political combination — to any change in the Relations sanctioned by existing Treaties. Calm and consistent in its proceedings, it has no other object than the maintenance of Peace, and the guarantee of those transactions on which the Peace was founded and consolidated."

## *Politics among Nations*

This answer, however, becomes highly ambiguous if one raises the further question as to what was meant by the status quo. What Great Britain meant from the very beginning was not at all what Russia meant, and the conception of the status quo which guided the policies of the Neo-Holy Alliance was diametrically opposed to the policies pursued by Castlereagh and Canning. The status quo which Great Britain tried to preserve through the instrumentality of the Holy Alliance was strictly limited to the political situation which existed at the end of the Napoleonic Wars with regard to France. To the British statesmen, the mortal peril into which Napoleon had put the British Isles was identical with the threat to the European balance of power which had emanated from the Napoleonic Empire. Great Britain was willing to support an international government whose purpose was to forestall the rise of a new conqueror from French soil and to that end to enforce the peace settlement of 1815 against France. The British conception of the status quo was limited to the territorial settlement of 1815 and the exclusion of a member of the Napoleonic family from the French throne. In this respect there was no difference between the foreign policies of Castlereagh and Canning.

The conception of the status quo which determined the policies of Russia from the beginning, and those of Austria, Prussia, and France from the end of the second decade of the nineteenth century, was unlimited territorially and as to subject matter. According to that conception, formulated in more uncompromising terms than the actual political conditions permitted to realize, it was the purpose of the international government of the Holy Alliance to maintain everywhere in the world the territorial status quo of 1815 and the constitutional status quo of the absolute monarchy. The instrument of the realization of the latter purpose was bound to be intervention into the internal affairs of all countries where the institution of the absolute monarchy seemed to be in danger.

The inevitable by-product of such intervention was an increase in the power of the intervening states. The more widespread national and liberal movements became, the greater was the chance for the intervening state or group of states to increase their strength and to expand and thus to disturb the balance of power again. The main beneficiary of such an eventuality was bound to be Russia. At this point Great Britain and Russia parted company.

Great Britain had not fought for almost a quarter of a century the Napoleonic Empire, nourished by the dynamism of the French Revolution, to exchange it for a Russian Empire, inspired by the religious mysticism of universal brotherhood and of legitimate government. In the measure in which the spread of national and liberal movements gave the Neo-Holy Alliance an opportunity to test its principles of general intervention, Great Britain held aloof from it and opposed its policies. When in 1818 Russia proposed to send an allied army to aid Spain in the war against its American colonies, Great Britain prevented the execution of the plan. Yet, when in 1820 revolutions broke out in Naples, Piedmont, and Portugal, Austria, in the name of the Neo-Holy Alliance, restored the absolute monarchies of Naples and Piedmont to their thrones by force of arms. In 1820, a revolution broke out in Spain. Against the constitutional regime installed by it, France intervened

by force of arms in 1823, acting on its own behalf, but with the moral support of Austria, Prussia, and Russia.

*d) Peace, Order, and the National Interest*

These actions of the Holy Alliance reveal two facts. One is the absence of a serious threat of war in any of these situations. The disparity of power between the intervening state and the object of intervention — the revolutionary group which had to contend not only with its own antirevolutionary compatriots, but also with a foreign army — was such as to give the intervention the character of a punitive expedition rather than of a war.

The other fact is the determination of the policies of all nations by their national interests, however much the language of diplomacy of the period made concessions to the mystical predilections of the Russian Czar. This is most obvious in the actions of Great Britain. Neither Castlereagh nor Canning — who was particularly frank and eloquent in this respect — took pains to hide the fact that they were guided by the traditional interests of Great Britain limited only by the general interest in peace and security. Both the Austrian intervention in Italy and the French intervention in Spain were dictated by traditional national interests. This connection is demonstrated by the very fact that the policy of interventions on the part of Austria and France in the affairs of their neighbors to the South survived the Holy Alliance by almost half a century.

More important still in view of our discussion is the victory which the particular national interests gained over the general principles of the Holy Alliance whenever both came into conflict. This happened twice, in 1820 and in 1822. In both cases Russia proposed a collective intervention on the part of all the members of the Alliance and to that end offered to send a large Russian army into Central and Western Europe. That Great Britain would have opposed such a proposal is obvious from what has already been said of the British return to its traditional balance-of-power policy. That Great Britain should have been joined in this opposition by Austria, the other pillar of the Neo-Holy Alliance, shows the ideological character of the principles of the Holy Alliance. These principles were invoked when they seemed to be able to give moral justification to policies dictated by the national interest. They were discarded when nothing was to be gained for the national interest by invoking them.

The attitude of the powers, when in 1821 the Greeks revolted against the Turks, is instructive in this respect. This is also the only situation arising during the era of the Holy Alliance which contained the germs of a general war and which in the century following it led time and again to the actual outbreak of war. The principles of the Neo-Holy Alliance left its members no choice in the attitude to be taken with respect to a national revolt against a legitimate government: the legitimate government ought to be given active support. Yet this was not the answer which the national interest of the most affected power demanded.

Russia had been the traditional protector of the subjects of the Ottoman Empire who were of the Orthodox Christian faith. The possession of Con-

## *Politics among Nations*

stantinople was a centuries-old dream of the rulers of Moscow. Thus, when the Greek revolt broke out, the Russian Czar was inclined, in complete disregard of the principles of the Neo-Holy Alliance, to declare war against Turkey. Austria and Great Britain, on the other hand, could only see then, as they had done before and as they would for almost a century, with misgivings the extension of Russian power in the Balkans and Russia's advance toward the Mediterranean. Thus Castlereagh, the opponent of the Neo-Holy Alliance, and the Austrian Chancellor Metternich, its ardent supporter, joined hands in order to dissuade Russia from taking active steps in support of the Greek insurgents. That they made for that purpose successful use of the principles of the Neo-Holy Alliance against their author is an ironic comment on the difficulties facing a foreign policy which is based upon abstract principles rather than upon a clear recognition of the national interest. As Castlereagh wisely put it: It is difficult enough in international affairs to hold the balance "between conflicting nations," it is still more difficult to hold the balance "between conflicting principles."

When, finally, in 1826 the danger of war between Russia and Turkey became acute, it was not the defunct Holy Alliance which averted it, but Canning's audacious move of entering into an agreement with Russia for the purpose of forcing Turkey to make concessions to the Greeks without Russia's gaining immediate advantages from such internal reforms. After Canning's death the event occurred which Canning had been successful in preventing, and in 1828 Russia alone declared war on Turkey, thus having the latter at its mercy. The outbreak of this war may have had something to do with the decline of British statesmanship after Canning's death. It certainly had nothing whatsoever to do with the absence of the international government of the Holy Alliance.

The Holy Alliance, then, was a short-lived experiment which contributed nothing to the maintenance of international peace. As an international government imposing its rule upon its sphere of domination it was successful for hardly more than half a decade. Two congenital infirmities made its early demise inevitable. One was the diametrical opposition between the two main members of the Alliance as to what the defense of the status quo—upon which they had all agreed as the guiding principle of justice in the abstract—meant in concrete political terms. That meaning was determined by the national interests of the individual members. If those interests happened to coincide, the Alliance could act in unison as one collective body. If those interests diverged, as they were bound to do from time to time and as they did permanently in the case of Great Britain and Russia, the Alliance ceased to operate.

The other infirmity from which the Holy Alliance suffered was the contrast between the principle of justice upon which Russia, Prussia, and Austria agreed as a guide to concrete political action, and the conception of justice adhered to by the majority of the individuals governed by the principles of the Holy Alliance. The conflict between the principles of legitimate government and the principles of liberalism and nationalism made the operation of an international government, inspired by the former, dependent upon the



## *International Government*

continuous use of armed force in order to protect and restore absolute monarchies and their possessions throughout the world.

It is a matter for conjecture how long an international government could have performed such a task had all its members shared the convictions and the zeal of Alexander I of Russia. The Holy Alliance could not prevail against the opposition of some of its members and of the peoples subject to its rule. In the era of Castlereagh, that dual opposition moved on parallel lines, Castlereagh limiting himself to abstaining from active co-operation with the policies of the Neo-Holy Alliance. It was Canning's great innovation, favored by the increasing strength of the national and liberal movements and later perfected by his successor Palmerston, to use those movements as allies for the purposes of British foreign policies, that is, as weights in the scales of the balance of power. With that innovation Canning ushered in the British policy toward the continent of Europe which was to remain dominant throughout the nineteenth century.

The international government of the Holy Alliance lacked any kind of permanent organization and consisted, aside from the ephemeral ambassadorial committees mentioned above, of nothing but a number of international congresses for the purpose of settling current international affairs. Nevertheless, the Holy Alliance was an international government in the true sense of the term. A partial list of the issues which were on the agenda of the Congress of Aix-la-Chapelle will illustrate the range of its governmental activities: the claims of the German mediatized princes against the abuses of their new sovereigns, the petition of the Elector of Hesse to exchange his title for that of king, the request by Napoleon's mother for the release of her son, the grievances of the people of Monaco against their prince, the claims of Bavaria and the House of Hochberg to the succession in Baden, a dispute between the Duke of Oldenburg and Count Bentinck about the lordship of Knuppenhausen, the situation of the Jews in Prussia and Austria, the rank of diplomatic representatives, the suppression of the slave trade and of the Barbary pirates, the question of the Spanish colonies.

### *e) The Concert of Europe*

In comparison with these widespread governmental activities of the Holy Alliance the subsequent century was retrogressive. The spectacle of a government of great powers sitting in judgment over the affairs of the world did not reappear until in 1919 the Council of the League of Nations re-enacted the role which the Holy Alliance had played. Yet the era between the Holy Alliance and the League of Nations was not devoid of *ad hoc* attempts at settling international problems through the concerted action of the great powers. After the demise of the Holy Alliance the great powers continued to assume responsibility for the settlement of political issues which without such settlement might have led to war. That responsibility expressed itself in a number of conferences, dealing with problems endangering the peace, such as the Belgian question at the beginning of the 1830's, the Eastern question at the beginning of the 1850's and again in 1878, the problems of Africa at

## *Politics among Nations*

the beginning of the twentieth century. It was to that responsibility of the great powers for the peace of the world, operating through *ad hoc* conferences and generally known as the Concert of Europe, that Sir Edward Grey appealed in vain on the eve of the First World War.

The Concert of Europe differed from a genuine international government in two respects. On the one hand, it was not institutionalized. There was no agreement among the great powers to meet regularly or to meet at all. The great powers met whenever the international situation seemed to demand concerted action. On the other hand, the Concert of Europe was no longer animated, as has already been noted,<sup>3</sup> by a strong moral consensus which could have neutralized conflicts and supplied standards for common judgments and actions. The cleavage between nationalism and legitimacy which the French Revolution had opened remained open throughout the nineteenth century. It might at times narrow or widen, but it did not close. Only at the end of the First World War did the national principle triumph and virtually all legitimate governments disappear.

Yet, despite the lack of a strong moral consensus, of an institutionalized government by conferences, let alone of an organized one, the Concert of Europe was most successful in preserving general peace during the ninety years of its existence. The only major international war which the world experienced during that period, the Crimean War of 1854-56, was due to a series of accidents. Had any one of these accidents failed to materialize the war might well have been avoided, for the Concert of Europe had already agreed upon the formula for peace when a delay of twenty-four hours in the transmission of the formula changed the whole picture.

What accounted for the success of the Concert of Europe in preventing general wars? Three factors must be mentioned. In that period of history the moral consensus of the European community lived on as a feeble echo, strengthened, however, by the humanitarian moral climate of the times. The political constellation, as we have seen,<sup>4</sup> favored expansion into politically empty spaces with accommodation of conflicting interests. Finally and most importantly, however, that period of history saw a succession of brilliant diplomatists and statesmen who knew how to make peace, how to preserve peace, and how to keep wars short and limited in scope. The portentous lesson which their work conveys to our age will be pondered later in this book.

### 2. THE LEAGUE OF NATIONS

With the end of the First World War a new epoch began in the history of international government. The League of Nations showed in its functions a great deal of similarity with the Holy Alliance. In its organization, however, it constituted a radical departure from the experiment which had preceded it a century before.

<sup>3</sup> See above, pp. 187 ff.

<sup>4</sup> See above, pp. 278 ff.

*a) Organization*

The League of Nations, in contrast to the Holy Alliance, was a real organization with a legal personality, agents, and agencies of its own. Its political agencies were the Assembly, the Council, and the Permanent Secretariat. The Assembly was composed of representatives of all the member states. In the Assembly as well as in the Council each state had one vote and unanimity of all members present was required for all political decisions, including those which concerned the prevention of war.<sup>5</sup> The main exceptions were Article 15, paragraph 10,<sup>6</sup> and the rule that in decisions concerning the settlement of international disputes the votes of the parties to the dispute were not to be counted.

The Council consisted of two types of members: permanent and nonpermanent. All great powers, belonging at a particular time to the League, were permanent members, e.g., originally France, Great Britain, Italy, and Japan, to which were later added Germany and the Soviet Union. The nonpermanent members numbered originally four. Their numbers were increased successively until in 1936 the Council comprised eleven nonpermanent members. Thus originally permanent and nonpermanent members were equal in numbers. From 1922 on, the nonpermanent members had an ever increasing majority over the permanent ones. In 1939, after Germany, Italy, and Japan had resigned and the Soviet Union had been expelled, the Council comprised two permanent (France and Great Britain) and eleven nonpermanent members.

Yet what is important in view of the distribution of power between great and small nations is not their numerical relationship, but the permanent membership of the great powers in the Council. By virtue of this permanent membership, in conjunction with the rule of unanimity, the great powers could be sure that the Council could make no decisions without the consent of all of them. Furthermore, the distribution of voting strength in an international agency never tells the whole story. No great power will ever be alone in voting in favor of or against a certain measure if it does not want to be alone, nor will any group of great powers ever risk to be outvoted if it is anxious not to be in the minority on a particular question. Most small and medium powers depend economically, militarily, and politically upon the support of a great power. Such a nation will hardly cast its vote against a great power which has intimated that the smaller nation is expected to heed

<sup>5</sup> Cf. the emphasis which the Permanent Court of International Justice placed upon the principle of unanimity in the Advisory Opinion concerning Article 3, paragraph 2, of the Treaty of Lausanne (Frontier between Turkey and Iraq): "In a body . . . whose mission is to deal with any matter 'within the sphere of action of the League or affecting the peace of the world,' observance of the rule of unanimity is naturally and even necessarily indicated. Only if the decisions of the Council have the support of the unanimous consent of the Powers composing it, will they possess the degree of authority which they must have: the very prestige of the League might be imperilled if it were admitted, in the absence of an express provision to that effect, that decisions on important questions could be taken by a majority. Moreover, it is hardly conceivable that resolutions on questions affecting the peace of the world could be adopted against the will of those amongst the Members of the Council who, although in a minority, would, by reason of their political position, have to bear the larger share of the responsibilities and consequences ensuing therefrom." (P. C. I. J. Series B, No. 12, p. 29).

<sup>6</sup> For the text see below, note 7.

## *Politics among Nations*

the advice of the big brother. Thus every great power controlled a number of votes of the small and medium members of the League. On any important issue France could be certain of the votes of Belgium, Czechoslovakia, Yugoslavia, Rumania, and—for more than a decade—Poland. Great Britain could count upon the votes of most of the dominions, of the Scandinavian countries, and of Portugal.

This controlling influence of the great powers, regardless of the legal structure of the organization, operated in the League of Nations side by side with the brilliant intellectual leadership of the representatives of a number of small and medium nations. Benes of Czechoslovakia, Politis of Greece, Nansen, Lange, and Hambro of Norway, Branting and Undén of Sweden, Titulescu of Rumania, and Motta and Rappard of Switzerland exerted an influence upon the work of the League of Nations out of all proportion to, and irrespective of, the power of their particular countries. The scene of that leadership was primarily the Assembly. The Assembly of the League of Nations, in contrast to the General Assembly of the United Nations, had the authority to render binding decisions not only with regard to routine matters or questions of secondary importance, but also concerning political problems, such as peace-preserving measures.<sup>7</sup> To that extent the Assembly of the League of Nations played the role of a real parliament where leadership fell many times to the best qualified representative, regardless of the power and sometimes even of the interests of his country.

However, that leadership stopped at the line where the vital interests of the great powers began. In the great crises of the League the leadership of the great powers asserted itself. When in a conflict of first-rate political importance, such as the Italo-Ethiopian War or the Spanish Civil War, the attitude of some of the small and great powers diverged, the policies of the great powers were bound to win. For the preponderance of the great powers on the international scene is a fact, as the preponderance of great economic organizations is a fact in domestic society. No legal arrangement nor organizational device, short of destroying that preponderance of power itself, can undo the political consequences of that disparity of power. Thus in the League the small nations enjoyed a greater opportunity for influence and independent action than they ever did before or since in modern times. Yet the international government of the League of Nations, at least in the sphere of high politics, was a government of the great powers.

---

<sup>7</sup> See Article 3, paragraph 3, of the Covenant: "The Assembly may deal at its meetings with any matter within the sphere of action of the League or affecting the peace of the world." See also Article 15, paragraphs 9, 10: "The Council may in any case under this Article refer the dispute to the Assembly. The dispute shall be so referred at the request of either party to the dispute provided that such request be made within fourteen days after the submission of the dispute to the Council.

"In any case referred to the Assembly, all the provisions of this Article and of Article 12 relating to the action and powers of the Council shall apply to the action and powers of the Assembly, provided that a report made by the Assembly, if concurred in by the Representatives of those members of the League represented on the Council and of a majority of the other members of the League, . . . shall have the same force as a report by the Council concurred in by all the Members thereof. . . ."

*b) Dual Meaning of the Status Quo: France vs. Great Britain*

What were the principles of justice which the international government of the League of Nations was to realize? That question has found a symbolic answer in the fact that the twenty-six articles of the Covenant of the League of Nations are identical with the first twenty-six articles of the peace treaties which settled the issues of the First World War. The intimate connection between the League of Nations and the status quo of 1919 was thus made obvious from the very outset. The provisions of the Covenant put that connection in explicit legal terms. The Preamble refers to "international law as the actual rule of conduct among governments" and to "a scrupulous respect for all treaty obligations." Article 10 makes the League of Nations the defender of the territorial status quo of 1919 by establishing the legal obligation of the members "to respect and preserve as against external aggression the territorial integrity and existing independence of all members of the League." All provisions of the subsequent articles concerning the settlement of disputes and its enforcement must be read in the light of this provision of Article 10. This provision lays down the standard by which the agencies of the League were to be guided in evaluating the claims and actions of nations and in devising methods to meet a threat to the peace.

It is true that the framers of the Covenant tried to relieve the League from the stigma of being completely identified with the status quo of 1919. To that end they provided in Article 19 for peaceful change. We have already pointed to the intrinsic weakness of that provision which remained a dead letter from the beginning. But aside from its intrinsic defects, Article 19 pales into insignificance if seen in its orphan-like isolation within the structure of the Covenant and if compared with the organic connection in which Article 10 stands to the peace treaties of 1919, on the one hand, and to the peace-preserving and law-enforcing provisions of Articles 11-16 of the Covenant, on the other. Article 19, then, was little more than a verbal concession to the undeniable fact of change. Its fundamental law no less than its origin, identical with the peace treaties of 1919, made it inevitable that the League as a working organization of international 'government should judge and act as the defender of the status quo.

Two principles were at the foundation of the status quo of 1919: the permanent inability of Germany to wage war and the principle of national self-determination. Yet, from the very outset, the two nations mainly responsible for the policies of the League, Great Britain and France, interpreted these two principles in distinctly different ways and tried to shape the policies of the League according to these different interpretations. For France, Germany's permanent inability to wage war was synonymous with the permanent preponderance of France on the continent of Europe. For Great Britain, Germany's permanent inability to wage war was not incompatible with the comeback of Germany as a great power within controlled limits so that at least the semblance of a balance of power would again exist on the continent of Europe.

France looked to the League of Nations primarily as a kind of collective

## *Politics among Nations*

sheriff which would add its strength to the military might of France for the defense of the status quo of 1919. Great Britain considered the League of Nations primarily a kind of clearing-house where the statesmen of the world would meet to discuss their common problems and seek agreement by way of compromise. Finally, France used the principle of national self-determination as a political weapon with which to strengthen its allies in Eastern Europe against Germany. Great Britain saw in it a principle capable of universal application, at least on the European continent, which one might well use to strengthen Germany at the expense of the allies of France.

At the bottom of these divergent interpretations of standards of justice and of political principles we find again the basic pattern of international politics. France subordinated all its policies as one of the leading members of the international government of the League of Nations to its overriding desire to maintain the status quo of 1919. This status quo was identical with France's hegemony on the European continent. Great Britain thought it could regain the controlling influence which it had exerted over the affairs of Europe during the nineteenth century. To that end it tried to restore the power constellation which had existed during that period: a balance of power on the European continent with Great Britain as its holder. Thus its policies as the other leading member of the international government of the League were all directed toward undermining the status quo of 1919 within limits which Great Britain thought it could determine at will. This goal of British foreign policy could only be attained by weakening France.

This conflict between the British and French conceptions and policies did not, however, wreck the League of Nations, as the conflict between Great Britain and Russia had brought about the dissolution of the Holy Alliance. It rather led to a creeping paralysis in the political activities of the League and to its inability to take determined action against threats to international order and peace. It culminated in the triumph of the British over the French conception. The distribution of power between Great Britain and France was in the main responsible for this development.

The margin of French superiority started to shrink in the mid-twenties in proportion to the growth of German strength, first slowly and imperceptibly and following Hitler's ascent to power with ever increasing speed. In 1919, France asked for the separation of the left bank of the Rhine from Germany and for treaties of alliance with Great Britain and the United States. France received neither. It was able to make only two additions to its own military strength which barely concealed its intrinsic weakness in comparison with the potentialities of German power. One addition was the alliances with Poland, Czechoslovakia, and Rumania, and the treaty of friendship with Yugoslavia. These allies, however, were at best medium states. Some, if not all of them, were militarily overrated and could not be relied upon to act always in unison. The other addition was the Locarno Treaties of 1925 putting the Franco-German frontier under the joint guarantee of Great Britain and Italy. Yet France was unable to obtain a similar guarantee for the German-Polish frontier, nor was it able to gain British support for an automatic system of collective security which would have

closed certain loopholes left open by the Covenant of the League of Nations.<sup>8</sup>

Under such conditions of hegemonial power in the short run and incurable weakness in the long run, France started in the mid-twenties to follow in its policies within the League of Nations the British lead, at first hesitatingly, and in the thirties without alternative.<sup>9</sup> For by then France's own indecision and now apparent weakness incapacitated it to seek on its own account the implementation of those provisions of the Covenant which could have enabled the League to play the role of an international government for the maintenance of international order and the prevention of war. France by itself had not the power to make the League play that role. Great Britain had no interest in making the League play it. For the performance of that role would have meant the perpetuation of unchallenged French supremacy on the European continent, which Great Britain was resolved to bring to an end. Thus the British conceptions and policies put their imprint upon the governmental activities of the League of Nations.

*c) Three Weaknesses of the League of Nations*

This is not to say that the League of Nations did not exercise important governmental functions. The League of Nations governed two territories: the Saar Basin and the City of Danzig. It governed indirectly — according to the text of Article 22 of the Covenant rather than in actuality — the mandated territories.<sup>10</sup> Yet, when it came to the maintenance of international order and the preservation or restoration of peace, it governed only in the rare instances when either the interests of the great powers among its members were not affected or the common interests of the most influential among them seemed to require it.

The League of Nations did not act as an international government when

<sup>8</sup> See below, pp. 376, 377.

<sup>9</sup> This trend was interrupted only for a short while in 1934 when the French Foreign Minister Barthou prepared the ground for a military alliance with the Soviet Union, which, however, none of his successors dared to implement. The foreign policy of Laval in that period, while strongly anti-British in intent, was identical with the British in undermining the status quo of 1919.

<sup>10</sup> Cf. the following provisions of Article 22: "To those colonies and territories which as a consequence of the late war have ceased to be under the sovereignty of the States which formerly governed them and which are inhabited by peoples not yet able to stand by themselves under the strenuous conditions of the modern world, there should be applied the principle that the well-being and development of such peoples form a sacred trust of civilisation and that securities for the performance of this trust should be embodied in this Covenant.

"The best method of giving practical effect to this principle is that the tutelage of such peoples should be entrusted to advanced nations who, by reason of their resources, their experience or their geographical position, can best undertake this responsibility, and who are willing to accept it, and that this tutelage should be exercised by them as Mandatories on behalf of the League. . . .

"In every case of mandate, the Mandatory shall render to the Council an annual report in reference to the territory committed to its charge.

"The degree of authority, control or administration to be exercised by the Mandatory shall, if not previously agreed upon by the Members of the League, be explicitly defined in each case by the Council.

"A permanent Commission shall be constituted to receive and examine the annual reports of the Mandatories and to advise the Council on all matters relating to the observance of the mandates."

## *Politics among Nations*

in 1920 Poland seized Vilna, the old Lithuanian capital; for that violation of international law was committed by the strongest ally of France. The League of Nations refused to act when in 1923 Italy occupied the Greek island of Corfu. It did nothing even approaching the nature of enforcement action after Japan invaded Manchuria in 1931, and after it invaded China proper in 1937. The League did nothing to prevent or stop the Chaco War between Bolivia and Paraguay in 1932-5, except to recommend an arms embargo at first against both belligerents and later against Paraguay alone. From 1935 on, the League did nothing effective to maintain its authority within the territory of the City of Danzig, and it did nothing in the face of the continuous violations of the Treaty of Versailles by Germany. What the League did in 1935-36 with respect to Italy's attack upon Ethiopia could not, as we have seen,<sup>11</sup> have been different had it been calculated to be ineffective. The League of Nations did nothing to control the international effects of the Spanish Civil War from 1936 on. In December 1939, however, the League expelled the Soviet Union because of its attack against Finland. It was the last and — aside from the sanctions against Italy — the most radical of the League's political actions.

The League of Nations prevented no major war, and it was ineffective in maintaining international order. The reasons for this failure, aside from the prevalence of the British conception over the French, are threefold: constitutional, structural, and political.

**CONSTITUTIONAL WEAKNESS.** Under the Covenant of the League of Nations, war as such was not outlawed. The members of the League were not allowed to go to war under certain conditions. By the same token they were allowed to go to war in the absence of those conditions. Thus the Preamble to the Covenant stipulated "the acceptance of obligations<sup>12</sup> not to resort to war." Article 12 provided that the members should not "resort to war until three months after the award by the arbitrators. . . ." By virtue of Article 13, paragraph 4, the members agreed "that they will not resort to war against a member of the League which complies" with the judicial decision of a dispute. Finally, according to Article 15, paragraph 6, "If a report by the Council is unanimously agreed to by the members thereof other than the Representatives of one or more of the parties to the dispute, the Members of the League agree that they will not go to war with any party to the dispute which complies with the recommendations of the report."

Only the two latter provisions contain an outright prohibition to go to war. As Mr. Jean Ray put it: "We are convinced that this timidity of the authors of the Covenant has serious consequences and puts in jeopardy the new system which they tried to erect. As a matter of fact, since the contrary opinion was not clearly expressed, it remained tacitly admitted that war is a solution, the normal solution, of international conflicts. These obligations, as a matter of law, are presented only as exceptions; the implicit rule is the recourse to war."<sup>13</sup> Even if the members had lived up to the provisions of

<sup>11</sup> See above, pp. 236, 336, 337.

<sup>12</sup> In contradistinction to "the obligation." The French text: ("*certaines obligations*") is more emphatic on that score.

<sup>13</sup> *Commentaire du Pacte de la Société des Nations* (Paris: Sirey, 1930), pp. 73-4.



the Covenant, they would have found in the fundamental law of the League an instrument for the prevention of some wars and for the legalization of others.

**STRUCTURAL WEAKNESS.** This constitutional weakness, however, did not affect the actual operations of the League; for the League did not live up to its constitution. On the other hand, the structural weakness of the League had a direct bearing upon its failure to prevent the wars which occurred under its jurisdiction. That weakness consisted in the contrast between the distribution of power within it and the distribution of power in the world at large.

The structure of the League was predominantly European in a period when the main factors of international politics were no longer predominantly European. Both great powers which in turn dominated it, France and Great Britain, were European powers. The only non-European great power which was a member of the League was Japan. Of the two nations which were already in the twenties and thirties potentially the two most powerful nations on earth, the United States was never a member, the Soviet Union only during the League's declining years from 1934-39.

It is, of course, true that of the thirty-one original members only ten were European and only seven of the thirteen states which joined it later. But here again numbers do not tell the story. An international organization whose main purpose is the maintenance of international order and the preservation of international peace does not need to be universal in the sense that all nations of the world belong to it. It must, however, be universal in the sense that all powerful nations, which are most likely to disturb the peace of the world, are under its jurisdiction.

Article 17 of the Covenant, therefore, attempted to make the jurisdiction of the League universal regardless of membership. It gave the League authority in case of a dispute between two states, one or both of which were not members of the League, to invite the nonmembers "to accept the obligations of membership in the League for the purposes of such disputes, upon such conditions as the Council may deem just. . . . If a state so invited shall refuse to accept the obligations of membership and shall resort to war against a member of the League," the sanctions of Article 16 shall be applicable against such a state. "If both parties to the dispute . . . refuse to accept the obligations of membership . . . the Council may take such measures, and make recommendations as will prevent hostilities and will result in the settlement of the dispute."

This last paragraph of Article 17 endeavored to make the League of Nations a world government for the purpose of preserving peace. The feasibility of such a government must again depend upon the distribution of power between the members of the League acting in unison and those states over which the governmental functions are to be exercised. The League would have had no difficulty in making its will prevail over two small or medium states. Let us suppose, however, that a dispute had broken out between a member of the League, on the one hand, and the United States or the Soviet Union or both, on the other, or between the two latter powers any time between 1919 and 1934, when neither country was a member of the

## *Politics among Nations*

League. Under such circumstances, the attempt to impose the League's will upon the United States or the Soviet Union or both would have amounted to a world war between the members of the League and either one or two of the potentially most powerful nations on earth, with a number of non-member states either joining the latter or remaining neutral. The attempt to preserve peace on a universal scale would have led to war on a universal scale.<sup>14</sup> Thus the membership of some great powers and the nonmembership of other great powers rendered the League powerless to preserve peace on a world-wide scale.

This lack of universality in the membership of the great powers also indicates the fundamental reason for the failure of British and French policies in the period between the two world wars. The policies of both countries were anachronistic. The policies of France might perhaps have succeeded in the age of Louis XIV. Then the main weights of the balance of power were located in Central and Western Europe, and such a preponderance as France gained in 1919 would have given it a real chance to establish its permanent hegemony over the continent. Yet after Russia had become one of the main factors in the balance of power, Napoleon had to learn that a hegemony over the European continent meant little with the resources of Eastern Europe and of the better part of Asia either uncommitted or hostile. This lesson was heeded by the brilliant French diplomatists who in the two decades preceding the First World War founded French foreign policy upon close ties with Russia. Their successors in the period between the two world wars based their hopes upon a system of alliances with the balkanized countries of Eastern and Southeastern Europe, a poor substitute for the "grand alliance" with Russia. Obsessed with the fear of revolution, very much like the French aristocrats in the years after 1789, they were ready to commit national suicide rather than to yield to the logic of a new international constellation.

British foreign policy in that period was as anachronistic as the French. Great Britain was intrinsically as weak with regard to the continent of Europe as France was with regard to Germany. The role which Russia played in relation to France, the United States and, to a much lesser degree, Japan played in relation to Great Britain. A policy which was still successful in the age of Disraeli was doomed to failure in the age of Stanley Baldwin. Throughout the nineteenth century, Great Britain's backyard, as it were, had been secure; the British Navy controlled the seas without challenge. In the thirties, other great naval powers had arisen, one of them potentially the most powerful nation on earth. Furthermore, the airplane brought the British Isles closer to the continent than they had ever been before. Under such conditions, British foreign policy had two alternatives. It could place its weight permanently in that scale of the European balance of power where British interests in the long run seemed to be most secure. Or it could make itself the spearhead of American policy in Europe.<sup>15</sup> What British policy

<sup>14</sup> The reader will remember that this situation is identical with the one which we found to exist when collective security is applied in actuality; cf. above, pp. 332 ff.

<sup>15</sup> It is worthy of note that Great Britain is now pursuing these two foreign policies simultaneously.

## *International Government*

could not do was to continue the policy of "splendid isolation." And this is what it did.

It will remain forever a moot question whether or not France and Great Britain had any real choice in the face of the policies actually pursued by the Soviet Union and the United States. It is, however, beyond doubt that an international government never had a chance whose leading members, either by choice or by necessity, followed policies so completely at odds with the actual distribution of power in the world.

**POLITICAL WEAKNESS.** This would have been true even on the assumption that the League of Nations had been able to act as a unit in the face of a threatening war of major proportions. Actually this assumption was never realized. Divergent national interests pursued by the great powers prevailed over the principles of justice defined by the League of Nations in terms of the status quo. In 1921, immediately after the First World War, the four permanent members of the Council of the League were still able to act in unison with respect to relatively important political issues, such as the fortification of the Aaland Islands involving Finland and Sweden and the partition of Upper Silesia which was a bone of contention between Germany and Poland. After these promising beginnings, it was not only the conflict between France and Great Britain which incapacitated the League for collective action on matters of major importance, but the separate and generally antagonistic policies of the great powers.

When Germany joined the League in 1925, it pursued a policy of undermining the status quo of Versailles, mainly using the principle of national self-determination as the dynamite with which to crack the foundations of the territorial status quo. This policy was at odds with the policies of France and its Eastern allies and was aimed, first surreptitiously and later openly, at the termination of their preponderance on the continent of Europe. In addition to the principle of national self-determination, Germany used the dual fear of Bolshevik revolution and Russian imperialism, which obsessed the Western powers, as a weapon with which to strengthen its own position. While alternately offering itself as a bulwark against Bolshevism and threatening to ally itself with the Soviet Union, Germany was able to wring concessions from the Western powers, to isolate Poland from France, and to paralyze the League.

Italy, on its part, pursued in the twenties a policy which was somewhat similar to the one pursued by Great Britain. Italy welcomed the comeback of Germany within certain limits as a means to weaken France and its Eastern allies, especially Yugoslavia. When in the thirties the impotence of the League had become obvious, Italy used Germany as Germany was using the Soviet Union: alternately as common menace and as a silent partner, and made an open bid against Great Britain and France for domination of the Mediterranean.

The Soviet Union was as isolated within the League as it had been without. Its potential strength as a nation and its sponsorship of world revolution made it a dual menace to the Western powers. It proved to be impossible for France, Great Britain, and the Soviet Union to unite for common action in

## *Politics among Nations*

any of the great crises from 1934-39, with the exception of the sanctions against Italy. In all those crises the Western powers and the Soviet Union found themselves in opposite camps. The Spanish Civil War is the outstanding example of this chronic antagonism. Even when in 1939 Germany threatened both the Soviet Union and the Western powers with war, they were unable to agree upon common preventive action. Instead, each side tried to deflect the threatening stroke of lightning against the other side. It was only the accident of Hitler's folly to wage war against both at the same time that made them allies despite themselves.

Finally, Japan, smarting under the inferiority which the treaties of 1922 had imposed upon it, prepared for the moment when it could establish its own hegemony in the Far East. Japan could do so only by dislodging Great Britain and the United States from their positions in the Far East and by "closing the door" to China which, as a matter of traditional policy, Great Britain and the United States had insisted upon keeping open for all nations. Thus, when Japan took the first step toward establishing its Far Eastern empire by invading Manchuria in 1931, it could not help but come into conflict with France and Great Britain, the leading members of the League of Nations. It is not without ironic significance that Japan, in establishing its dominion, made use of the same principle of national self-determination which had carried France and Great Britain to dominance in the League of Nations. Now it was employed to rally the colored races of the Far East against the colonialism of the leaders of the League. Yet neither while Japan remained a member of the League nor after its resignation in 1932 did Great Britain feel strong enough to lead the League in effective collective action in order to stop Japan's attack against China.

The ability of the League of Nations to prevent war was predicated upon the unity of its members and especially of the great powers. By virtue of the principle of unanimity, any member of the League, except parties to a dispute, could veto a decision by voting against a motion to take action. Given the antagonistic policies pursued by the leading members of the League, the very likelihood of a veto impeded even attempts at decisive collective action. Only an overriding principle of justice could have made such action possible. As we have seen, such principles of justice did exist in the abstract as collective defense of the status quo against the nations vanquished in the First World War and as national self-determination.

Confronted with a political situation demanding concrete action, these abstract principles transformed themselves into ideological justifications for the separate policies pursued by the individual nations. Thus these abstract principles of justice, far from providing common standards of judgment and guides for common action, actually strengthened international anarchy by strengthening the antagonistic policies of individual nations. The inability of the League of Nations to maintain international order and peace, then, was the inevitable result of the ascendancy which the ethics and policies of sovereign nations were able to maintain over the moral and political objectives of the international government of the League of Nations.

3. THE UNITED NATIONS

*a) Government by Superpowers*

In its organization the United Nations resembles the League of Nations. It, too, has three political agencies: the General Assembly composed of all members of the United Nations, the Security Council as the political executive of the organization, and the Secretariat. The distribution of functions between the General Assembly and the Security Council, however, differs distinctly from that between the Council and the Assembly of the League of Nations. The tendency toward government by the great powers, which was already unmistakable in the League of Nations, completely dominates the distribution of functions in the United Nations. This tendency manifests itself in three constitutional devices of the Charter: the inability of the General Assembly to make decisions in political matters; the limitation of the requirement of unanimity to the permanent members of the Security Council; the right of parties to disputes to veto enforcement measures against themselves.

The Assembly of the League of Nations was, as we have seen, a real international parliament, which could take action in political matters alone or in competition with the Council of the League. The General Assembly of the United Nations, according to Articles 10-14 of the Charter, has only the power to make recommendations in political matters either to the parties concerned or to the Security Council. With regard to the maintenance of international peace and security it can debate, investigate, and recommend, but it cannot act. Even those modest functions are qualified by Article 12 of the Charter which precludes the General Assembly from making even recommendations on matters which are on the agenda of the Security Council. Thus the concurrent jurisdiction of a deciding Council and a deciding Assembly, which was a distinguishing feature of the League of Nations, is replaced by the alternate jurisdiction of a deciding Security Council and a recommending General Assembly. When the Security Council concerns itself with a matter, the General Assembly may still debate, but it can no longer even recommend.

This device enables the Security Council to control indirectly the functions of the General Assembly in matters of political importance. By simply putting a matter on its agenda, the Security Council can transform the General Assembly into a debating society which has not even the right to express its collective opinion on such a matter. It has been said that these provisions designate the General Assembly as "the open conscience of the world."<sup>16</sup> Even if this were so, it is a strange conscience indeed which can never decide but always talk, which can recommend only at somebody else's pleasure, and which has no control whatsoever over the actions of the personality to which it belongs.

As a matter of fact, this reduction of the functions of the General As-

---

<sup>16</sup> Leland M. Goodrich and Edvard Hambro, *Charter of the United Nations* (Boston: World Peace Foundation, 1946), p. 95.

## *Politics among Nations*

sembly has had two unfortunate results which have already become obvious. On the one hand, it has prevented the rise of talented statesmen who, regardless of nationality and of the national power they represent, could make useful contributions to the solution of international problems. Where there is no opportunity for constructive action, talent cannot prove itself and responsibility declines.

On the other hand, the United Nations has been endowed with a split personality. The General Assembly may with two-thirds majority recommend to the Security Council a solution of an international problem which the Security Council may disregard at its discretion. This discretion of the Security Council would be no serious matter if the General Assembly were an advisory body of limited membership and not the representative body of virtually all the nations of the world. As it is, the distribution of functions between the Security Council and the General Assembly is a constitutional monstrosity. The United Nations may speak with respect to the same issue with two voices: one the General Assembly's, the other the Security Council's, and between these two voices there is no organic connection. Two-thirds or more of the total membership of the United Nations may recommend one thing, and seven of the eleven members of the Security Council may disregard the recommendation and decide something else.

The vice of this constitutional arrangement does not lie in the predominance of the great powers, which we found to exist in the Holy Alliance and the League of Nations as well. It rather lies in the grotesque and unnecessary opportunity which it gives to the General Assembly to demonstrate its impotence to all the world. The Holy Alliance was frankly an international government of the great powers. The League of Nations was an international government of the great powers with the advice and consent of all member nations, each of which, by virtue of the principle of unanimity and save for Article 15, paragraph 10, of the Covenant,<sup>17</sup> could stop the international government from acting. The United Nations is an international government of the great powers which resembles in its actuality the Holy Alliance and in its pretenses the League of Nations. It is the contrast between pretense and actuality, between the democratic expectations roused by the words of the Charter and the autocratic performance assured by the actual distribution of functions, which has harmed the authority of the United Nations and impaired its ability to maintain international order and peace.

The international government of the United Nations, then, is identical with the international government of the Security Council. The Security Council seems to be, as it were, the Holy Alliance of our time. Yet in actuality it is the five permanent members which are supposed to perform the governmental functions. We have seen that the principle of unanimity has been abrogated with respect to all decisions of the Security Council and has been replaced with regard to substantive decisions by the requirement of seven affirmative votes in which the votes of the five permanent members must be included. Given the preponderant influence of the five permanent members (China, France, Great Britain, the Soviet Union, the United

---

<sup>17</sup> For the text see above, pp. 233, 234.

## *International Government*

States), their unanimous decision will have no difficulty in attracting at least two more votes of other members of the Security Council.

The United Nations, then, is predicated upon the continuing unity of the permanent members of the Security Council. In the scheme of the Charter these five members are, as it were, the nucleus of a world federation, a Holy Alliance within a Holy Alliance. By limiting the principle of unanimity to them, the Charter makes them the international government of the United Nations. It follows that with but one permanent member dissenting there can be no international government of the United Nations.

This great power monopoly of governmental action is still further enhanced by Article 27, paragraph 3, according to which a party to a dispute is prevented from voting only with regard to the pacific settlement of disputes under Chapter VI of the Charter. In other words, the great power veto applies to the enforcement measures under Chapter VII. When a great power is a party to a dispute, the Security Council can render a decision by virtue of Article 27, paragraph 3, regardless of the attitude of that great power. If the Security Council should try to enforce that decision, the dissent of any of the great powers, although a party to the dispute, would erect a legal barrier to enforcement action. In such a contingency the decision of the Security Council would remain a dead letter.

Actually, however, the international government of the United Nations is government of the great powers to a still greater degree than the foregoing analysis would indicate. Of the five permanent members of the Security Council only two, the United States and the Soviet Union, are really great powers. Great Britain and France are medium powers, and China is only potentially a great or even medium power. Under the present conditions of world politics, most nations are in the orbit of either the United States or the Soviet Union and can be prevailed upon, if need be, to support the position taken by one or the other of the superpowers. This will always be true of most members of the Security Council, the permanent members included. The international government of the United Nations, stripped of its legal trimmings, then, is really the international government of the United States and the Soviet Union acting in unison. At best—if they are united—they can govern the rest of the world for the purpose of maintaining order and of preventing war. At worst—if they are disunited—there will be no international government at all.

Ideally the United Nations is an instrument for governing the world through the combined power of the United States and the Soviet Union. Under no conceivable conditions, however, can the United Nations operate as an international government for the purpose of establishing or maintaining order in the relations between the United States and the Soviet Union or of preventing war between them. The Charter of the United Nations is not devised for the purpose of subjecting the United States and the Soviet Union to an international government against their will. The instrumentalities of the United Nations may be used by one or the other of the superpowers for such a purpose. The United Nations would, then, transform itself from an international government for the preservation of peace into a grand alliance for the waging of war.

## *Politics among Nations*

### *b) Undefined Principles of Justice*

Like the conflict between Great Britain and Russia within the Holy Alliance, like the conflict between Great Britain and France within the League of Nations, so the conflict between the United States and the Soviet Union within the United Nations resolves itself into diametrically opposed interpretations of the standards of judgment and action which the international organization is supposed to realize. It must, however, be noted that the Charter of the United Nations invites such divergent interpretations. The standards of justice which shall guide the judgment and actions of the agencies of the United Nations are found in three places: in the Preamble, in Chapter 1 dealing with Purposes and Principles, and interspersed through the Charter. Yet, in contrast to the basic principles of the Holy Alliance and of the League of Nations, the principles of justice upon which the United Nations is founded are beset by two kinds of inner contradictions: one concerning the mode of actions to be performed by the United Nations, the other concerning the purposes for which the actions are to be performed.

The Preamble reaffirms "faith . . . in the equal rights . . . of nations large and small," and Article 2, paragraph 1, declares that "the Organization is based on the principle of sovereign equality of all its Members." That principle is strengthened by Article 2, paragraph 7, which exempts "matters which are essentially within the domestic jurisdiction of any state" from the jurisdiction of the United Nations, except in so far as enforcement measures under Chapter VII are concerned.<sup>18</sup> Yet the whole structure of the United Nations, as laid out in the main body of the Charter, is based upon what one might call paradoxically the "sovereign inequality" of its members. We have already pointed to the fact that if the United Nations were to operate as provided for in its Charter, all its members who are not members of the Security Council would lose their sovereignty and would remain sovereign in name and form only.<sup>19</sup> Thus the principle of sovereign equality proclaimed by the Charter in its initial provisions is contradicted by the actual distribution of functions which the Charter itself provides.

The Preamble and Chapter 1 formulate five political purposes of action: (1) maintenance of international peace and security, (2) collective security, (3) prohibition of the use of force "against the territorial integrity or political independence of any state" and reservation of its use for "the common interest" as defined in the Charter, (4) maintenance of "justice and respect for the obligations arising from treaties and other sources of international law," and (5) national self-determination.

Of these five purposes the first two are general and of an instrumental nature. They tell us that whatever the United Nations does it should do peacefully and according to the principle of collective security. The other three principles are specific and concrete. They tell us what the United Nations should or should not do in concrete situations. It should use force under certain conditions and not use it under others; it should act justly and in

---

<sup>18</sup> Cf. what has been said about the destructive effect which the reservation of domestic jurisdiction has upon international obligations, p. 223.

<sup>19</sup> See above, pp. 255, 256.



harmony with the rules of international law and with the principle of national self-determination.

It is significant that the Charter is most explicit in elaborating and implementing the first two purposes (cf. particularly Chapters VI and VII) and that it is virtually silent with regard to the remaining three. Article 11, paragraph 1, and Article 24, paragraph 2, refer the General Assembly and the Security Council in general terms to the Purposes and Principles as guides for their deliberations and actions. But the concrete meaning of concepts, such as justice, respect for international law, and national self-determination, is not self-evident nor is it the same everywhere and at all times. In the abstract, most men may be able to agree upon a definition of those terms. It is the concrete political situation which gives these abstract terms a concrete meaning and enables them to guide the judgment and actions of men. Nowhere in the main body of the Charter is there a definition of, or reference to, a substantive principle of justice. Nor are there any other sources which would give unequivocal content to these abstractions. Here is the core of the disease which from the very beginning has prevented the international government of the United Nations from coming to life.

*c) The Undefined Status Quo: the Soviet Union vs. the United States*

When the Holy Alliance and the League of Nations were established, there already existed a status quo, a certain distribution of power agreed upon by all the major members of the international government. That pre-existing political order was the foundation upon which the international government was built and which gave concrete meaning to its principles of justice. Dissensions arose as to the interpretation of that status quo and to its further development. The status quo itself, won in a common victory over a common enemy and defined in treaties of peace, was the common starting point for all concerned. After the Second World War, the would-be peacemakers reversed the sequence. They first created an international government for the purpose of maintaining the status quo and after that proposed to agree upon the status quo. To this day no such agreement has been reached.

It has been said that this reversal of the traditional sequence was a master stroke of statesmanship; for it spared the Charter of the United Nations the fate which the Covenant of the League of Nations received at the hands of the United States Senate. Being an integral part of the Treaty of Versailles, the Covenant fell with that treaty. The Charter, standing alone, was not affected by whatever criticism might be leveled against the settlement of the Second World War.

Be that as it may, the erection of a structure of international government upon what proved to be no political foundation at all has been a failure which threatens to come crashing down and bury the peace of the world beneath its ruins. The United Nations is like a building designed by two architects who have agreed upon the plans for the second floor, but not upon those for the first. Each of them builds his wing of the first floor as he sees fit, each doing his best to obstruct the efforts of the other. In consequence, not only

## *Politics among Nations*

does the second floor become an unlivable abode, but the whole structure threatens to disintegrate.

PROVISIONAL CHARACTER OF THE STATUS QUO. The new territorial status quo which has existed since the end of the Second World War is in the main a military one. In the relations between the United States and the Soviet Union it consists of the lines of demarcation upon which Great Britain, the Soviet Union, and the United States agreed at Yalta in 1945. Both sides have recognized these lines of demarcation as provisional. The internal organization of Germany remains likewise provisional; the very future of a unified German state is in doubt. The same holds true for Austria. There is no agreement as to the Western frontiers of Germany. With regard to the Eastern frontiers, there is outspoken disagreement between the Soviet Union and Poland claiming that these frontiers were definitely determined by the Potsdam Agreement of 1945, and the Western powers which regard these frontiers as provisional and subject to final determination by a peace conference. Not only is the territorial status quo in Europe provisional, but the reason for its being provisional is the seemingly unbridgeable disagreement between the Soviet Union and the Western powers as to what a definite status quo should be like. In their defeat, Germany and Austria have become a bone of contention between the East and the West. The Soviet Union wants to keep control of the sections of these countries which it occupies at present and to dislodge the Western powers from the zones which they control, and vice versa.

This tension between the East and the West is all-pervading and paralyzes the international government of the United Nations not only in its over-all functions, but also in what are in themselves only technical matters of secondary importance. To what extent this is true can be gathered from the hopeless impasse which has made it impossible for the East and the West to agree upon the selection of a governor for the Free Territory of Trieste.

Trieste is the main Mediterranean outlet for trade from Central and Eastern Europe and the main port of the Adriatic. As such, Trieste has been coveted by Yugoslavia since the dissolution of the Austrian Empire in 1919 when the city was given to Italy. In the peace treaty with Italy the Allies were able to agree upon a compromise which made Trieste a Free Territory. Not unlike the way in which Danzig was governed from 1919 to 1939, Trieste was to be governed by the United Nations through a governor to be appointed by the Security Council.<sup>30</sup> The Soviet Union did not want to strengthen the West by leaving the city under Italian rule. The Western powers did not want to strengthen the East by allowing Yugoslavia to extend its domain over the city. The result of this unresolved antagonism was what might be called the neutralization of the city. This solution left in suspense the distribution of power between Yugoslavia and Italy and, hence, between the East and the West. In Italy's loss the West lost a port—whose hinterland, however, is almost wholly controlled by the East—without the East gaining it. This compromise was a diplomatic achievement of sorts.

Yet the all-pervading tension between East and West made the implementation of this compromise impossible. For the "neutralization" of Tri-

<sup>30</sup> Article 11 of Annex VI of the Treaty of Peace with Italy (*New York Times*, January 18, 1947), pp. 25 ff.

este to be effective, a neutral administration by a neutral governor under the supervision of a neutral Security Council was needed. The Security Council of the United Nations was unable to accomplish what with regard to Danzig the Council of the League of Nations succeeded in doing at least in a certain measure. The Security Council could not find a neutral governor because there were no neutrals left in the world. Candidates who were agreeable to the East had for that very reason to be rejected by the West, and vice versa.

The deadlock over the governorship of Trieste thus offers a striking example of how the objective conditions of world politics make international government impossible even where in a special case a new status quo and the organization and functions of the international government have been agreed upon. Despite such agreement concerning the city of Trieste, the provisional status quo continued as it was established at the end of hostilities with a tripartite military administration (American, British, Yugoslav) performing the functions of government.

**INSTABILITY OF THE STATUS QUO.** Disagreement as to the future status quo between the East and the West and, more specifically, between the United States and the Soviet Union is, however, not limited to regions, such as Central Europe, where the status quo is provisional. Such disagreement extends even to regions where the Second World War did not even raise the question of the status quo or where in the closing stages of the war agreement had already been reached as to the future status quo. The outstanding example of the former alternative is Turkey; of the latter, Greece, Iran, and China.

For centuries the Dardanelles have been a goal of Russian aspirations, and for more than a century Russia has tried to use Turkish weakness for the purpose of gaining direct or indirect possession of what Bismarck called "the key to Russia's house." Yet the door to which the Dardanelles are the key does not only allow the outside world to enter Russia; it also gives Russia an exit into the outside world. The Dardanelles are not only the opening through which a hostile power can penetrate the Black Sea, attack the oil resources and one of the main industrial and agricultural centers of Russia, and by turning north make the Russian position in Eastern Europe untenable. The Dardanelles control also the access from the Black Sea to the Mediterranean and the route which leads from the Balkans to Asia. Thus, whenever Russia was about to use its superior army to take possession of that coveted prize, the superior navy of Great Britain would block the way, either alone or in conjunction with the Austrian army. Only once did Russia seem virtually to have reached the goal of its ambition when, during the First World War, Great Britain promised Russia the Dardanelles as one of the prizes of victory. Yet the separate peace which the Bolshevik regime concluded with the Central Powers annulled the promise.

The traditional role of Great Britain is now being performed by the United States. Otherwise the basic constellation has not changed. What the Soviet Union wants, the United States refuses to concede. The United States wants to maintain the status quo with respect to the Dardanelles; the Soviet Union wants to change it.

For more than a century the problem of Greece has been intimately con-

## *Politics among Nations*

nected with the problem of the Dardanelles. Greece flanks Turkey to the West, and the Dodecanese Islands lie athwart the Mediterranean approaches to the Dardanelles. Great Britain has traditionally considered Greece an indispensable factor for the defense of the Dardanelles and, hence, as lying within the British sphere of influence. In an informal understanding in 1944, Great Britain and the Soviet Union divided the Balkans on traditional lines, leaving Greece within the British sphere of influence. This understanding meant the ratification of the status quo which for a century had existed in the Balkans.

The United States has become the successor of Great Britain as the protector of Greece from Russian influence. Yet the Greek civil war has reopened the question of the status quo seemingly settled by the Russo-British agreement of 1944. For the revolt against the Greek government is more than a domestic upheaval. The revolutionaries are supported by Albania, Yugoslavia, and Bulgaria, three Russian satellites which would not give such aid without Russian approval. Since the Communists are the dominant group among the revolutionaries, their victory would of necessity mean the extension of Russian influence to the Aegean. Thus the issue of the Greek civil war is explicitly the status quo in the Balkans between the Soviet Union and the United States and implicitly the control of the Dardanelles.

We have already mentioned the traditional role which Iran has played in the relations between Great Britain and Russia.<sup>21</sup> British and Russian influence has fluctuated back and forth on the territory of Iran. Uneasy compromises have from time to time attempted to limit Russian influence to the north and British influence to the south, both countries most of the time trying to expel the other side from its sphere and to extend its own over the whole of Iran. During the Second World War, Russian troops occupied the north and British troops the south of Iran. In an agreement concluded in 1942, both countries pledged themselves to evacuate their troops within six months after the conclusion of hostilities and thus to restore the status quo *ante bellum*. Russian troops stayed on after the expiration of the time limit, and it needed pressure exerted in the Security Council to bring about the withdrawal of Russian troops in 1946. In exchange, Iran granted the Soviet Union oil concessions in the northern part of the country. Yet in 1947 the Iranian parliament, yielding to American pressure, refused to ratify the treaty. Thus the question of the status quo has been reopened by both sides and remains unsettled.

Finally, the Yalta Agreement of 1945 between Great Britain, the Soviet Union, and the United States, and the subsequent agreements between China and the Soviet Union provided for the internationalization of the Chinese port of Dairen, the lease of Port Arthur to the Soviet Union as a naval base, and the joint Russo-Chinese operation of the Chinese Eastern and South Manchuria railways. These arrangements amounted to the restoration of the status quo between China and the Soviet Union which had existed before the Russo-Japanese War of 1904.

But the Chinese civil war has raised the question of the status quo again.

---

<sup>21</sup> See above, pp. 39, 40.

## *International Government*

The Chinese civil war is, on the one hand, a domestic problem of China. Because of the ideological affinity between the Chinese Communists and the Russian regime, the civil war poses the same problem which the Boxer Rebellion of 1900 and the Japanese invasions of 1931 and 1937 had posed: the problem of the Open Door. Yet it is a new version of the old problem.

The traditional policy of the Open Door meant to keep the Chinese door open for everybody, with everybody having equal opportunity and with nobody receiving special privileges. The new policy of the Open Door aims at keeping the door of China wide open for one country and keeping it tightly shut for others. If the government wins the civil war, it is supposed that the door will be shut for the Soviet Union and kept open for the Western powers. If the Communists win, it is anticipated that the Chinese door will be open for the Soviet Union and closed for the Western powers. Thus the stakes of the Soviet Union and of the United States in the Chinese civil war are the exercise of exclusive influence over the natural and population resources of China. The status quo with regard to China is, then, completely in flux. The outcome of the civil war is supposed to decide whose influence will prevail in China: that of the United States or that of the Soviet Union.<sup>22</sup>

From Stettin to Mukden the status quo is unsettled, the United States and the Soviet Union promoting settlements which are mutually exclusive. Yet these are the two nations upon whose agreement as to what the status quo shall be and how it shall be enforced the international government of the United Nations is predicated. The United Nations cannot bring this agreement about. It presupposes it. Since such agreement has never existed during the short life of the United Nations, the international government of the United Nations, envisaged by the Charter, has not become a reality.

Experience has shown that the attempt to use the United Nations for the purpose of forcing upon either of the superpowers such agreement only aggravates the disagreement and increases the danger of war. We have already seen that the Charter enables the United Nations, that is, the United States and the Soviet Union acting in unison, to prevent wars among the other nations. Built upon the foundation of the United States and the Soviet Union acting as one, the United Nations is constitutionally unable to prevent a war between those two countries. Yet it is such a war which today threatens the United States, the Soviet Union, and all mankind. For its prevention we must look elsewhere than to the United Nations.

---

<sup>22</sup> The 450 million Chinese might, however, decide — regardless of who should win the civil war — that it should be neither and that Chinese influence should prevail in China.

*PART NINE*

THE PROBLEM OF PEACE  
IN THE MID-TWENTIETH  
CENTURY: PEACE THROUGH  
TRANSFORMATION



## CHAPTER XXVI

### *The World State*

Our investigation of the problem of international peace has left us with two conclusions: no attempt to solve the problem of international peace by limiting the national aspirations for power has succeeded, and none could have succeeded under the conditions of the modern state system. What, then, accounts for the instability of peace and order in the relations among states, and what accounts for their relative stability within states? In other words, what factor making for peace and order exists within national societies, which is lacking on the international scene? The answer seems to be obvious — it is the state itself.

National societies owe their peace and order to the existence of a state which, endowed with supreme power within the national territory, keeps peace and order. Such was indeed the doctrine of Hobbes who argued that without such a state national societies would resemble the international scene and the war "of every man against every man"<sup>1</sup> would be the universal condition of mankind. From this premise it was logically inevitable to conclude that peace and order among nations would be secure only within a world state comprising all the nations of the earth. Since the breakdown of the universal order of the Middle Ages this conclusion has been advanced from time to time.<sup>2</sup>

Under the impact of two world wars within a quarter of a century and the prospects of a third one to be fought under the modern conditions of warfare, the propaganda for a world state has reached broad masses and has imparted to them a peculiar sense of urgency. We are told that we are lost if we should fail to establish a world state within the period of a few years. What is needed in order to save the world from self-destruction is not the limitation of the exercise of national sovereignty through international obligations and institutions, but the transference of the sovereignties of individual states to a world authority which would be as sovereign over the individual nations as the individual nations are sovereign within their respective territories. Reforms within the international society have failed and were bound to fail. What is needed, then, is a radical transformation of the

<sup>1</sup> *Leviathan*, Chapter XIII.

<sup>2</sup> Cf. the references above, pp. 309, 310.



## *Politics among Nations*

existing international society of sovereign nations into a supranational community of individuals.

The argument rests upon an analogy with national societies. It is, therefore, our first task to find out how peace and order are preserved in national societies.

### I. CONDITIONS OF DOMESTIC PEACE

Peace among social groups within the state reposes upon a dual foundation: the disinclination of the members of society to break the peace and their inability to break the peace if they should be so inclined. Individuals will be unable to break the peace if overwhelming power makes an attempt to break it a hopeless undertaking. They will be disinclined to break the peace under two conditions. On the one hand, they must feel loyalties to society as a whole which surpass their loyalties to any part of it. On the other hand, they must be able to expect from society at least an approximation to justice through the at least partial satisfaction of their demands. The presence of these three conditions — overwhelming force, suprasedsectional loyalties, expectation of justice — makes peace possible within states. The absence of these conditions on the international scene evokes the danger of war.

What are the factors which make for the presence of these conditions? And what is the role which the state plays in this respect? A closer consideration of the interplay of social forces which make for peace within the state will help us to answer these questions.

#### *a) Suprasedsectional Loyalties*

National societies are composed of a multiplicity of social groups. Some of these are antagonistic to each other in the sense that their respective claims are mutually exclusive. That mutual exclusiveness of opposing claims is particularly obvious in the economic sphere where one group may demand a share in the economic product which another group refuses to grant. This problem of the distribution of profits is only a spectacular instance of a ubiquitous social phenomenon. Political parties, religious denominations, racial groups, regions, and localities meet in similar contests. How are those conflicts being prevented from degenerating into violence?

First of all, citizen A, who as a member of economic group  $E_1$  opposes citizen B as member of another economic group  $E_2$ , is unable to identify himself completely with  $E_1$  and to give it his undivided loyalties. He is unable to do so for three reasons.

A is not only a member of  $E_1$ , but also of the religious group R, the political group P, and the ethnic and cultural group C. All these groups make demands on his allegiance, and if he wants to do justice to all of them he cannot identify himself completely with any. While he acts as a member of  $E_1$ , he cannot forget that he has also responsibilities to R. While he throws himself into the struggle for the objectives of P, he cannot help being mindful of what he owes to C. This pluralism of domestic groupings and conflicts,

then, tends to impress upon the participants the relativity of their interests and loyalties and thus to mitigate the clashes of different groups. This pluralism brings about, as it were, an economy of the intensity of identification, which must be spread wide in order to give every group and conflict its share.

Furthermore, while A as a member of E<sub>1</sub> opposes B as a member of E<sub>2</sub>, he might find himself on the same side of the fence with B, both being members of P. In other words, A and B are enemies in the economic sphere, yet they are friends in politics. They are opposed to each other economically, yet they are united politically. A and B are also members of religious, ethnic, and regional groups, and so forth, and both of them may have similar relations of conflict and association with any number of members of these groups. A, then, is not only at the same time identified with a plurality of different social groups, he is also as a member of these different groups simultaneously the friend and foe of any number of his fellows, in so far as they belong to different groups of which he is either a member or an opponent.

This plural role of friend and opponent which A plays with regard to a number of his fellows imposes restraints upon him as both a friend and a foe. He cannot identify himself completely with his political friends who are also his economic opponents without the risk of losing the struggle for economic advantage. He cannot push the struggle for economic advantage to extremes without losing the political support which he needs as a member of the political group. If A wants to be economic opponent and political friend at the same time, he must take care to be both within such limits that one does not get in the way of the other. Thus the overlapping of social roles played by different members of society tends to neutralize conflicts and to restrain them within such limits as to enable the members of society to play their different roles at the same time.

Finally, A and B are not only members of contending economic groups and have not only identical political affiliations, not to speak of all the other social groupings to which they belong, but by definition they are also members of the same national society. They partake of the same language, the same customs, the same historic recollections, the same fundamental social and political philosophy, the same national symbols. They read the same newspapers, listen to the same radio programs, observe the same holidays, and worship the same heroes. Above all, they compare their own nation with other nations and realize how much more they have in common with each other than with members of the other nations. More particularly, they realize that the national characteristics which they have in common are superior in all important respects, especially those of morality, to the qualities of those who belong to a different nation. Thus A and B come to feel not only that they belong to the same national family, but also that because of that family relation they have something very precious in common, something that enhances their worth and makes them "better" men in every important respect in comparison with outsiders.

The self-respect of A and B as well as the esteem in which they hold each other is intimately connected with their membership in the same national community. Their intellectual convictions and moral valuations derive from that membership. How that membership gives vicarious satisfaction to their

## *Politics among Nations*

power drives has already been related in detail.<sup>3</sup> The loyalties with which they cling to the nation are more than the mere repayment of a debt of gratitude for benefits received. They are the very conditions of those benefits. It is only by being faithful to the nation, by adhering to it as to the fountain-head of all earthly goods, by identifying one's self with it that one will experience as one's own the security of belonging, the exultation of national pride, the triumphs of the Fatherland in the competition with other nations. Thus protection of the nation against destruction from without and disruption from within is the overriding concern of all citizens. Likewise, loyalty to the nation is a paramount commitment of all citizens. Nothing can be tolerated that might threaten the coherence of the nation. Interests, ideas, and loyalties which might not be compatible with the concern for the unity of the nation must yield to that concern.

This concern imposes an ever present limitation upon the kind of issues which separate A and B and places ever present restraints upon the methods by which A and B fight these issues out. Whatever the stakes of their conflicts, they will not raise the issue of national unity itself. Whatever methods A and B may employ in order to settle the conflict on their own terms, they will not resort to measures which might put the coherence of the nation itself in jeopardy. All conflicts within a nation are thus limited as to objectives pursued and means employed. They are, as it were, embedded within the densely woven fabric of the national community which keeps them within bounds. In conjunction with the pluralism and overlapping of sectional loyalties it is the limiting and restraining influence of national loyalties which constitutes the first of the three factors which make for peace within the nation.

### *b) Expectation of Justice*

How do national societies create the expectation on the part of hostile social groups that none of their claims will be completely ignored, but that all have a chance for at least partial satisfaction? How are all contending groups enabled to expect at least an approximation to justice from the national society to which they belong?

In national societies the problem of justice is posed on two levels. One is the level of general principles shared by society as a whole; the other is the level of specific claims advanced by particular groups. On the level of general principles no threat to the peace arises, for all are agreed upon the general principles by which the common good of society is defined. Principles, such as democracy, social justice, equality, freedom of speech, do not give rise to conflicts endangering the peace of society so long as they remain in the realm of abstractions defining the ultimate goal of society's collective endeavors.

These abstractions, however, become potent weapons in social conflicts when seized upon by social groups which advance their conflicting claims in the name of these principles. These claims confront society with its su-

<sup>3</sup> See above, pp. 76 ff.

preme challenge. Society may be able to disregard the claims of small and weak groups without endangering its peace. Its social cohesion and monopoly of organized violence are strong enough to keep the resentment and disaffection of such small and weak groups from turning openly against the social order. Yet society cannot afford to remain deaf to the claims for justice of large and potentially powerful groups without inviting the risk of revolution and civil war, that is, without endangering its peace and its very survival as an integrated whole.

It is here that the intricate mechanism of peaceful change comes into play, giving all groups a chance to submit their claims for justice to the arbitration of public opinion, of elections, of parliamentary votes, of examination boards, and the like. We have already sketched the workings of these mechanisms in another context and refer the reader to it.<sup>4</sup> These mechanisms guide the conflicting claims of social groups into peaceful channels by giving them a chance to make themselves heard and to compete with each other for recognition according to rules binding upon all. Under the conditions of these contests, no group can be sure to prevail in the long run, but all groups can rely upon the chance of taking at one time or another some forward steps toward the attainment of justice.

### *c) Overwhelming Power*

The third factor in preserving peace within national societies is the overwhelming power with which society can nip in the bud all attempts at disturbing the peace. This overwhelming power manifests itself in two different ways: in the form of material force as a monopoly of organized violence and in the form of irresistible social pressure.

The power which is at the disposal of society in the form of a monopoly of organized violence is set apart by two characteristics from any other form of violence, especially the one which we encounter in the international sphere.

The organized violence of national societies is in large measure neutral with regard to the conflicting claims of social groups so long as they remain within the limits of the law and avail themselves of peaceful means. The liberal doctrine of the nineteenth century held that the organized violence of society was completely neutral, standing above the turmoil of conflicting interests, ready to enforce the law against whoever had violated it. Against that doctrine Marxism claims that the organized violence of society is nothing but the weapon with which the ruling class maintains its rule over the exploited masses. Actually the compulsory organization of society cannot be completely neutral; for the legal order which it enforces is not, as we have seen,<sup>5</sup> completely neutral, but cannot help favoring the status quo to which it owes its existence. If challenged, the status quo can count upon the support of the compulsory organization of society.

It is, however, the peculiar characteristic of the compulsory organization of society that it has a bias in favor of the status quo, but in large measure

<sup>4</sup> See above, pp. 350 ff.

<sup>5</sup> See above, pp. 342, 343, 348.

## *Politics among Nations*

not a bias in favor of any particular status quo. The compulsory organization of American society has defended the status quo of 1800, of 1900, of 1932, and of 1940. The compulsory organization of British society has supported in succession the status quo of feudalism, capitalism, and socialism. Yet it may be that a particular status quo is offensive to the fundamental moral convictions and the vital interests of a considerable portion of the population and that a considerable fraction of the enforcement officials sympathize with their uncompromising opposition to the status quo. In such a case, the legal order embodying the status quo will not be enforced. In the United States the constitutional background of the Civil War and the fate of prohibition illustrate that case.

The other characteristic peculiar to the compulsory organization of national societies is the scarcity of its collective action. As a rule, the compulsory organization of national societies maintains peace and order only against individual lawbreakers. It is a rare exception for it to oppose as a collective force another collectivity which threatens to disturb the peace. The use of force in labor disputes is the outstanding example of this kind. The very existence, in the hands of society, of a monopoly of organized violence, ready to intervene in case of need, seems to be the main contribution of organized violence to the maintenance of domestic peace. The very fact of its existence relieves the compulsory organization of society from the necessity to act.

Aside from this factor and probably surpassing it in importance, there is the enormous unorganized pressure which society exerts upon its members for keeping the peace. A group, in order to be able to escape that pressure, would have to erect within the very framework of the national society a social structure of its own, more integrated, more compelling, and commanding higher loyalties than the national society in whose midst it exists. In our times the intensity of nationalism, its transformation into the political religion of nationalistic universalism, the ubiquity of the modern mass media of communications, and their control by a small and relatively homogeneous group have multiplied and magnified the social pressures which in national societies tend to keep dissenting groups within the bounds of law and peace.

### *d) The Role of the State*

What is the contribution of the state to the maintenance of domestic peace? "State" is but another name for the compulsory organization of society, that is, for the legal order which determines the conditions under which society can employ its monopoly of organized violence for the preservation of order and peace. When we have spoken in the preceding pages of the compulsory organization and of the legal order of society we have really spoken of the state. It follows that the state is only one of the factors upon which the peace of national societies reposes. Its functions for the maintenance of domestic peace are threefold.

(1) The state provides the legal continuity of the national society. It thus enables the individual to experience the nation as a continuum in time and space, as a personality in whose name men act, who demands and receives services and bestows benefits, to whom one can feel personal loyalties as few

other social groups except the family and the church receive. (2) The state provides most of the institutionalized agencies and processes of social change. (3) The state provides the agencies for the enforcement of its laws.

It remains for us to determine how important the state's contribution to domestic peace is. The answer to this question is twofold. The state's contribution to domestic peace is indispensable, but it is not in itself sufficient. Without the state's contribution there can be no domestic peace, but with nothing but the state's contribution there can be no domestic peace either.

That there can be no domestic peace without the state is already implicit in what we have said about the problems of power, of the balance of power, and of sovereignty. Hostile social groups will use whatever means are at their disposal for the purpose of gaining the objectives which they consider vital to themselves. If such social groups control the means of physical violence, as sovereign states do in their mutual relations, they will use them in two different ways. They will either exert pressure upon their opponents by displaying what they consider to be their superiority, or they will employ them for the destruction of the opponent's means of physical violence. In either alternative the purpose of physical violence is the breaking of the opponent's will to resist the demands of the other side.

The history of national societies shows that no political, religious, economic, or regional group has been able to withstand for long the temptation to advance its claims by violent means if it thought it could do so without too great a risk. However strongly the other social factors might have supported the cause of peace, their effectiveness did not long survive the promise of a speedy and definitive victory which violence holds out to its possessor. Thus national societies have disintegrated and have split into a number of smaller units, either temporarily or permanently, whenever the state was incapable of maintaining its monopoly of organized violence and of using whatever means of violence it retained for the purpose of maintaining peace and securing its own survival.

Since whoever is able to use violence will use it if the stakes seem to justify its use, a social agency is needed which is strong enough to prevent that use. Society might find substitutes for the legal unity which the state conveys to it in time and space and for the agencies for social change through which the state regulates the dynamics of the social processes. Society has no substitute for the power of the Leviathan whose very presence, towering above contending groups, keeps their conflicts within peaceful bounds.

The state is indispensable for the maintenance of domestic peace. Such is the true message of Hobbes's philosophy. Yet the state by itself cannot maintain domestic peace. Such is the great omission of Hobbes's philosophy. That the power of the state is essential, but not sufficient, to keep the peace of national societies is demonstrated by the historic experience of civil wars. If there had been only few of them over a long period of history they might be disregarded as exceptions to the rule. However, Professor Quincy Wright has shown that of a total of two hundred and seventy eight wars fought between 1480 and 1941, seventy-eight — 28 per cent of the total — were civil wars. In the period from 1840 to 1941, the ratio between civil and international wars was, with eighteen of the former and sixty of the latter, approximately one

## *Politics among Nations*

to three. For the period between 1800 and 1941, the figures are twenty-eight for civil and eighty-five for international wars with the ratio being almost exactly one to three.<sup>6</sup> Concerning the costliness of civil wars Professor Wright observes: "Civil wars such as the French Huguenot wars of the sixteenth century, the British War of the Roses of the fifteenth century and the Civil War of the seventeenth century, the Thirty Years' War from the standpoint of Germany, the Peninsula War, from the standpoint of Spain, the American Civil War, and the Chinese Taiping Rebellion were costly both in lives and in economic losses far in excess of contemporary international wars."<sup>7</sup>

The frequency and destructiveness of civil wars demonstrates that the existence of the state gives no assurance for the preservation of domestic peace. The reason is to be sought in the nature of the state itself. The state is not a thing apart from society, but is a product of society. The state is not the artificial creation of a constitutional convention, conceived in the image of some abstract principles of government and superimposed upon whatever society there might exist. On the contrary, the state is what the society is from which it has sprung, and prospers and decays as society prospers and decays.

The peace of a society whose intergroup conflicts are no longer limited, restrained, and neutralized by overriding loyalties, whose processes of social change no longer sustain the expectation of justice in all the major groups, and whose unorganized forces of compulsion are no longer sufficient to impose conformity upon those groups — the peace of such a society cannot be saved by the state, however strong. The forces of destruction arising within society in the form of class, racial, religious, regional, or purely political struggles will erupt in revolutions, coups d'état, and civil war. The state does not stand apart from these conflagrations as a fire department stands apart from fires, ready to extinguish them when they break out. The state is inevitably involved in these conflagrations in a dual sense. On the one hand, the state is the prime target of revolution, against which it must defend itself by the use of force. On the other hand, the dissensions which disrupt society also split its compulsory organization, the state. The state, then, will either cease to operate as one body, its discordant parts will join the warring groups in society at large, and the unity of the state will dissolve in civil war. Or — what is more likely in our time in view of the modern technology of war — the issues which divide the people are fought out not by the people at large, but through internecine struggles within the organization of the state in the form of coups d'état, conspiracies, and purges.<sup>8</sup>

## 2. THE PROBLEM OF THE WORLD STATE

Our analysis of the problem of domestic peace has shown that the argument of the advocates of the world state is unanswerable: There can be no permanent international peace without a state coextensive with the confines

<sup>6</sup> *A Study of War* (Chicago: University of Chicago Press, 1942), I, 651.

<sup>7</sup> *Ibid.*, p. 247.

<sup>8</sup> On the obsolescence of popular revolutions in our times, see above, pp. 299 ff.

of the political world. The question which calls now for our attention concerns the way in which a world state can be created.

In the first chapter of his *Considerations on Representative Government* John Stuart Mill faced the same problem with respect to particular forms of government. The two "conflicting conceptions of what political institutions are," which Mill found to be at the basis of all discussions of his problem, determine also the discussions of how to create a world state. By one school of thought "government is conceived as strictly a practical art, giving rise to no questions but those of means and an end. Forms of government are assimilated to any other expedients for the attainment of human objects. They are regarded as wholly an affair of invention and contrivance. Being made by man, it is assumed that man has the choice either to make them or not, and how or on what pattern they shall be made. . . . To find the best form of government; to persuade others that it is the best; and having done so, to stir them up to insist on having it, is the order of ideas in the minds of those who adopt this view of political philosophy. They look upon a constitution in the same light (difference of scale being allowed for) as they would upon a steam plough, or a threshing machine."

The other school of thought regards government "as a sort of spontaneous product, and the science of government as a branch (so to speak) of natural history. According to them, forms of government are not a matter of choice. We must take them, in the main, as we find them. Governments cannot be constructed by premeditated design. They 'are not made, but grow.' . . . The fundamental political institutions of a people are considered by this school as a sort of organic growth from the nature and life of that people: a product of their habits, instincts, and unconscious wants and desires, scarcely at all of their deliberate purposes. Their will has had no part in the matter but that of meeting the necessities of the moment by the contrivances of the moment, which contrivances, if in sufficient conformity to the national feelings and character, commonly last, and by successive aggregation constitute a polity, suited to the people who possess it, but which it would be vain to attempt to superduce upon any people whose nature and circumstances had not spontaneously evolved it."

Mill took his stand between the extremes of these two doctrines, availing himself "of the amount of truth which exists in either." On the one hand, "political institutions . . . are the work of men; owe their origin and their whole existence to human will. . . ."

"On the other hand, it is also to be borne in mind that political machinery does not act of itself. As it is first made, so it has to be worked, by men, and even by ordinary men. It needs not their simple acquiescence, but their active participation; and must be adjusted to the capacities and qualities of such men as are available. This implies three conditions. The people for whom the form of government is intended must be willing to accept it; or at least not so unwilling as to oppose an insurmountable obstacle to its establishment. They must be willing and able to do what is necessary to keep it standing. And they must be willing and able to do what it requires of them to enable it to fulfil its purposes. . . . They must be capable of fulfilling the conditions of action, and the conditions of self-restraint, which are necessary



## *Politics among Nations*

either for keeping the established polity in existence, or for enabling it to achieve the ends, its conduciveness to which forms its recommendation.

"The failure of any of these conditions renders a form of government, whatever favourable promise it may otherwise hold out, unsuitable to the particular case."

This triple test devised for specific forms of government may well be applied to the world state. Are the peoples of the world willing to accept world government, or are they at least not so unwilling as to oppose an insurmountable obstacle to its establishment? Would they be willing and able to do what is necessary to keep world government standing? Would they be willing and able to do or refrain from doing what world government requires of them to enable it to fulfill its purposes? The answers to these questions are implicit in what has been said above in connection with the problems of nationalism, nationalistic universalism, international morality, and world public opinion.<sup>9</sup> The answers are also implicit in what has been said about the conditions for the maintenance of domestic peace. The answer is bound to be a threefold "no."

No society exists coextensive with the presumed range of a world state. There exists an international society of sovereign nations. There does not exist a supranational society comprising all individual members of all nations and, hence, identical with humanity politically organized. The most extensive society in which most men live and act in our times is the national society. The nation is, as we have seen, the recipient of man's highest earthly loyalties. Beyond it there are other nations, but no community for which man would be willing to act regardless of what he understands the interests of his own nation to be. Men are willing to give food, clothing, and money to the needy regardless of nationality. But they prefer to keep them in Displaced Persons Camps rather than to allow them to go where they please and thus to become useful citizens again. For while international relief is regarded as compatible with the national interest, freedom of immigration is not. Under the present moral conditions of mankind, few men would act on behalf of a world government if the interests of their own nation would require a different course of action. On the contrary, the overwhelming majority would put the welfare of their own nation above everything else, the interests of a world state included. In other words, the peoples of the world are not willing to accept world government, and their overriding loyalty to the nation opposes an insurmountable obstacle to its establishment.

Nor are the peoples of the world willing and able to do what is necessary to keep world government standing. For they are not prepared to perform that revaluation of all values, that unprecedented moral and political revolution which would force the nation from its throne and put the political organization of humanity on it. They are willing and able to sacrifice and die so that national governments may be kept standing.

The odds are to such an extent in favor of the nation that men who might be willing and able to sacrifice and die that the world state be kept standing do not even have the opportunity to do so in the world as it is con-

---

<sup>9</sup> See pp. 74 ff., 187 ff., and Chapter XV.

stituted today. The man who would want to oppose the interests and policies of his own nation for the sake of humanity and its state would by that act of opposition (weakening his own nation) strengthen the nation with which his own government might be engaged in deadly combat. At best he might make himself the martyr of his convictions by inviting the punishment which the nation metes out to traitors. Nothing shows more strikingly the absence of the social and moral preconditions for anything resembling a world state than the moral paradox that a man who would want to act as a citizen of the world would by the conditions of the world be forced to act as partisan of another nation and as traitor to his own. For above one's own nation there is nothing on behalf of which a man could act. There are only other nations besides one's own.

Finally, the peoples of the world are not willing and able to do what the world state requires of them to enable it to fulfill its purposes. The prime purpose of a world state would be to maintain the peace of the world. To that end, the world state would have to perform three functions: (1) it would give humanity a legal personality which would keep the unity of mankind before its eyes; (2) it would create and keep in motion agencies for social change of a world-wide character which might allow all groups of mankind to expect at least some satisfaction for their conflicting claims; (3) it would establish enforcement agencies which would meet any threat to the peace with overwhelming strength. One might concede the possibility, for which there is support in the public opinion polls referred to above,<sup>10</sup> that the peoples of the world would support the world state in the performance of function (1). Enough has already been said on the absence of support for function (3) to be performed by the world state.<sup>11</sup> Let us, then, briefly examine the chances of the peoples of the world supporting the world state in the performance of function (2) which, as we know, is the very heart of the peace-preserving functions of any state.

We shall not dwell upon the problem as to how the different peoples of the world shall be represented in legislative agencies for social change. Numerical representation would obviously be unacceptable to the white races, since it would put the world under the domination of the colored ones. Any type of representation which in violation of the majority principle would tend to stabilize white supremacy in the world would meet with the opposition of the colored races, who would thus be held in a permanent state of inferiority. Nor shall we dwell upon the obvious impossibility of putting such legislative agencies in operation, even if it should be possible to establish them. A parliament representing peoples of such different moral convictions, political interests, and abilities for self-government as the Americans, the Chinese, the Indians, and the Russians would hardly be able to create out of these differences an operating whole. None of its constituent groups would willingly submit to the majority vote of a legislative assembly thus constituted. The threat and the actuality of civil war would hang over such institutions, which would have to substitute compulsion for the lacking moral and political consensus.

<sup>10</sup> See p. 262n.

<sup>11</sup> See above, pp. 262, 263.

## *Politics among Nations*

Let us consider two concrete issues with regard to which the claims of different nations traditionally collide: immigration and trade. A world state, no more than any other federal state, could leave the regulation of interstate migration and interstate trade to the discretion of its component parts. It would itself have to regulate these issues. Even if the authority of the world state in these two respects were strictly circumscribed by the world constitution, is there any chance that the American people would be prepared to give a world government powers to open the borders of the United States for the annual immigration of, say, 100,000 Russians, 50,000 Chinese, and 200,000 Indians, since they are not prepared to allow the immigration of even a fraction of those who might have immigrated under the laws of the United States had not the Second World War prevented them from doing so? Is it likely that the Russian people would be inclined to allow the annual emigration of 100,000 Russians to the United States, since they are not inclined to allow the emigration of even a score or so of Russian wives of British citizens?

Is it likely that the American people would allow the import of any quantity of foreign agricultural products which might compete with domestic ones on equal terms, since they do not allow, even if the federal tax should be repealed, domestic margarine to compete with domestic products on equal terms? Is there any likelihood that the Russians would allow cheap consumer goods to be imported, which might upset their planned economy and undermine confidence in their political system as well? If these questions must be answered in the negative, as obviously they must, how is a world state expected to govern at all? How is a world state expected to be able to resolve peacefully the tensions between nations which threaten the peace of the world?

There is no shirking the conclusion that international peace cannot be permanent without a world state, and that a world state cannot be established under the present moral, social, and political conditions of the world. In the light of what has been said thus far in this book there is also no shirking the further conclusion that in no period of modern history was civilization more in need of permanent peace and, hence, of a world state, and that in no period of modern history were the moral, social, and political conditions of the world less favorable for the establishment of a world state. There is, finally, no shirking the conclusion that as there can be no state without a society willing and able to support it, there can be no world state without a world community willing and able to support it.

### 3. TWO FALSE SOLUTIONS

How, then, can a world state be created? Two solutions have been offered: world conquest and the examples of Switzerland and of the creation of the United States by the Constitutional Convention of 1787.

a) *World Conquest*

All historic political structures which have come close to being world states have had one thing in common: One powerful state created them by conquering the other members of what was then the known political world. Most of these world states have another thing in common: They hardly ever survived the lifetime of their founders.

In Western civilization the sole exception to that rule is the Roman Empire. This world state owed its unique longevity to two unusual transformations. The Roman conquerors transformed the conquered into Romans either by receiving them into the dominant civilization as Roman citizens or by uprooting them from their native civilizations and making them into slaves. Yet in the process of conquest, especially of the Hellenistic world, the Roman conqueror transformed himself by remaking his own civilization in the image of the civilizations of the conquered. Through this dual process of amalgamation, Rome created a new moral and political community coextensive with its conquests and capable of lending stability to the new state. To these two transformations must be added the further circumstance that after the conquest of the Mediterranean world the Roman Empire expanded into politically empty spaces, settled by barbarians whose loosely organized civilizations disintegrated under the impact of the superior and attractive civilization of the conqueror.

Most of the other world states disintegrated as soon as conquest had built them. For, beneath the political and military superstructure erected by force, the national societies lived on, each with its separate moral values and political interests and each trying to shake off the conqueror's yoke. These world states were not the natural outgrowth of a world community coextensive with them, but a creation of force artificially superimposed upon a multiplicity of unwilling national societies. It is of course true that, for instance, Napoleon's would-be world state was destroyed by the untapped reserves of Great Britain and Russia. Yet, when in 1812 that empire for the first time showed its military weakness by failing in a major task of expansion, the national societies of which it was composed reasserted themselves and joined Great Britain and Russia in putting an end to it.

Conquests on a smaller scale which are unable to unite the conquering and conquered populations in a new community face the smaller risk of revolt and irredentist separatism. The relations between Ireland and Great Britain, and Poland and Russia are cases in point. If the conqueror can muster overwhelming strength, no danger to the peace may arise from the conflict of two national societies living within the same state. If, however, the strength of the conquered people is not out of all proportion to the conqueror's, a potential state of civil war between the conqueror and the conquered will sap the strength of the state, even though under the modern conditions of warfare it may not endanger its existence.<sup>12</sup>

Such are the likely consequences of limited conquests which are unable to create a new community coextensive with themselves. It follows that a world

---

<sup>12</sup> Cf. on this point above, pp. 102, 103, 299 ff.

## *Politics among Nations*

state created by conquest and lacking the support of a world community has a chance to maintain peace within its borders only if it can create and maintain complete discipline and loyalty among the millions of soldiers and policemen needed to enforce its rule over an unwilling humanity. Such a world state would be a totalitarian monster resting on feet of clay, the very thought of which startles the imagination.

### *b) 'The Examples of Switzerland and the United States*

What the world state is expected to bring about, Switzerland seems to have already achieved—the creation of a new federal state out of a number of sovereign nations with language, culture, history, loyalties, and policies of their own. Switzerland has been able to unite twenty-two sovereign states, speaking four different languages, in one political organization. Why should the sixty-odd nations of the world not be able to do the same? Let them adopt a federal constitution as the Swiss have done, let them act toward each other as the Swiss states do, and the problem of the world state will be solved. The argument seems to be persuasive and is considered frequently in popular discussions. It dissolves, however, when confronted with the facts of Switzerland's history.

First of all, the unified Swiss state dates from 1848. Before, the Swiss states formed a confederation which resembled more a successful League of Nations or United Nations than a single state. That confederation grew from a number of permanent alliances concluded among the so-called Forest Cantons and some of the City Cantons in the course of the fourteenth century. These alliances were the result of certain identical and complementary interests which drew these states together in defense against common dangers. Why did these alliances survive the special occasions from which they arose and even harden into the close ties of a confederation with common agencies of government? The answer to that question will provide the explanation to the phenomenon of Switzerland.

(1) The thirteen members of the original Confederation, occupying a contiguous territory, were united in a common opposition to the German Empire and the Hapsburgs, of whom they had all been subjects, from whom they had liberated themselves in common efforts, and who, or their successors, remained the common enemies of the liberties of all of them. (2) The famous victories of the Swiss armies over the knights in the fourteenth and fifteenth centuries had a dual effect. They established for centuries the reputation of the Swiss as the most redoubtable soldiers in Europe, and they proved the virtual immunity from foreign attack of the mountain valleys where the Forest Cantons were located. (3) Compared with these military risks which an attack upon the Swiss entailed, the attractions of victory were small. In view of the poverty of these valleys in natural resources, these attractions were exclusively strategic, that is, the control of some of the Alpine passes joining Italy with the North of Europe. Yet for four centuries, with the one significant exception of the Napoleonic Wars, the great rival powers adjacent to Switzerland found it more advantageous to have the Swiss defend the Alpine passes against all warring nations than to try to capture them from the Swiss.

It is, however, significant that the balance of power exerted this protective influence only as long as the rivalry among Switzerland's powerful neighbors lasted. The Napoleonic victories in Italy at once destroyed that protection and from 1798 on Switzerland was the hapless prey of contending armies. It is also worth remembering that while Austria, Germany, and Italy were joined in the Triple Alliance, the Italian General Staff proposed six times to the German General Staff to march through Switzerland in a joint campaign against France.

Thus it was not merely an act of will expressing itself in a constitutional arrangement, but a number of peculiar and, in their combination, unique circumstances which made it possible for Switzerland to be born and to survive. It must be added that while these circumstances allowed Switzerland to survive in the midst of powerful neighbors, they did not permit it to maintain peace among its component states. Within the span of little more than 300 years, the Swiss states fought among themselves five religious wars involving all or virtually all of them, the last as late as 1847, and numerous minor wars in which only a few states participated. A great number of revolutions and coups d'état round out the picture of civil strife.

What light, then, does the history of Switzerland shed upon the problem of the world state? We can subscribe to Professor Rappard's conclusions that Switzerland as a confederation had limited national security only "by virtue of special circumstances alien to this regime itself. . . . In so far as the Swiss experience of five centuries of collective security can suggest a lesson to the present generation, this lesson is clearly negative. It confirms at the same time the observations drawn from the most recent past and the teachings of simple common sense. As long as the security of the international society depends only upon the free cooperation of fully sovereign states, it remains necessarily fragile."<sup>18</sup> Thus the Swiss experience confirms our own conclusions concerning the fragility of peace by limitation, while it emphasizes both the need and difficulty of establishing a state above the national states.

The example of the way in which the United States was created is often cited as proof of the feasibility of creating a world state here and now by way of a constitutional convention. Actually, the example of the United States proves only the dependence of any state, which can be expected to endure, upon a pre-existing moral and political community.

When the Constitutional Convention met in 1787, the thirteen states were sovereign in name rather than in political actuality. They did not constitute thirteen separate sovereignties which were about to merge into a single one. After they had declared their independence from Britain in 1776, sovereignty remained in suspense. By establishing the United States, they exchanged one sovereignty, that of the British Crown, for another. And they exchanged one common loyalty for another common loyalty. All the while they retained the same language, the same culture, the same national heritage, the same moral convictions, the same political interests which had just been tested in the action of a revolutionary war fought in unison under a single command. The thirteen colonies formed a moral and political community under the British

<sup>18</sup> William E. Rappard, *Cinq Siècles de Sécurité Collective (1291-1798)* (Paris: Librairie du Recueil Sirey, 1945), p. 594.

## *Politics among Nations*

Crown, they tested it and became fully aware of it in their common struggle against Britain, and they retained that community after they had won their independence.

What the Convention of Philadelphia did was to replace one constitution, one sovereignty, one state with another one, both resting upon the same pre-existing community. The Convention did not create one state where before there had been thirteen separate ones. Far from proving that a state can be created by agreement on the text of a constitution, the creation of the United States proves the truth of the two propositions advanced earlier on these pages: Wars can occur within states as well as among states, and the United States was founded upon a moral and political community which the Constitution did not create, but found already in existence. The community of the American people antedated the American state, as a world community must antedate a world state.

## CHAPTER XXVII

# *The World Community*<sup>1</sup>

This last conclusion, that a world community must antedate a world state, has given birth to two efforts to create a world community: the United Nations Educational, Scientific and Cultural Organization, known as UNESCO, and the other specialized agencies of the United Nations.

### 1. THE CULTURAL APPROACH: UNESCO

According to Article I of the Constitution of UNESCO:

The purpose of the Organization is to contribute to peace and security by promoting collaboration among the nations through education, science and culture in order to further universal respect for justice, for the rule of law and for the human rights and fundamental freedoms which are affirmed for the peoples of the world, without distinction of race, sex, language or religion, by the Charter of the United Nations.

To realise this purpose the Organization will:

- (a) collaborate in the work of advancing the mutual knowledge and understanding of peoples, through all means of mass communication and to that end recommend such international agreements as may be necessary to promote the free flow of ideas by word and image;
- (b) Give fresh impulse to popular education and to the spread of culture; by collaborating with Members, at their request, in the development of educational activities;
- by instituting collaboration among the nations to advance the ideal of equality of educational opportunity without regard to race, sex or any distinctions, economic or social;
- by suggesting educational methods best suited to prepare the children of the world for the responsibilities of freedom;
- (c) maintain, increase and diffuse knowledge;
- by assuring the conservation and protection of the world's inheritance of books, works of art and monuments of history and science, and recommending to the nations concerned the necessary international conventions;
- by encouraging cooperation among the nations in all branches of intellectual

---

<sup>1</sup> Read in connection with this chapter what has been said above in Chapter XV about world public opinion.



## *Politics among Nations*

- activity, including the international exchange of persons active in the fields of education, science and culture and the exchange of publications, objects of artistic and scientific interest and other materials of information;
- by initiating methods of international cooperation calculated to give the people of all countries access to the printed and published materials produced by any of them.

In order to evaluate the contribution which UNESCO is able to make for the preservation of international peace, three distinctions must be made. (1) We are here not concerned with the contribution which UNESCO is able to make to the dissemination and the improvement of culture and education as ends in themselves. (2) We are here not concerned with the contribution which UNESCO is able to make for the preservation of international peace through the very fact of international co-operation. This aspect of the problem will be dealt with in the last section of this chapter. (3) We are here concerned only with the question of what UNESCO can do for the preservation of international peace by promoting international understanding, education, and general cultural activities.

Two quotations may set the tone for our discussion. The Carnegie Endowment for International Peace declared in its appraisal of UNESCO's program for 1948: "The projects themselves were loosely catalogued and often individually vague. There was mixture and confusion of objectives, areas of work, and techniques of action in the individual projects. UNESCO was to 'stimulate' or 'promote' or 'study' or 'coordinate'; the program was not incisive and clear-cut. Above all else its individual items were not always clearly and obviously related to the safeguarding of peace and security."<sup>2</sup> The United States National Commission for UNESCO said with respect to the same program: "The Commission does not approve the proposals respecting the conservation of nature and wildlife, not because they lack merit but because they do not appear to be appropriate for undertaking by UNESCO as a contribution to peace and security."<sup>3</sup>

What these two agencies have pointed out with respect to particular programs is true of all activities of UNESCO: How meritorious they may be intrinsically, they are not "clearly and obviously related to the safeguarding of peace and security." This defect is not an accidental quality of certain programs undertaken by UNESCO, which only need to be revised and tightened in order to fulfill their peace-preserving function. On the contrary, that defect is congenital, growing from the very philosophy which is at the foundation of the agency and permeates all its activities.

The philosophy of UNESCO starts with the assumption that education (especially when it aims at international understanding), cultural interchange, and in general all activities which tend to increase contacts among members of different nations and to make them understand each other are factors in the creation of an international community and in the maintenance of peace. Implicit in this assumption is the supposition that nations are nationalistic and go to war with each other because they do not know each other

---

<sup>2</sup> *International Conciliation*, No. 438, February 1948, p. 77.

<sup>3</sup> *State Department Release*, NC3/6 (Rev.), September 22, 1947, p. 7.

## *The World Community*

well enough and because they operate on different levels of education and culture. Both assumptions are erroneous.

There are primitive peoples, completely lacking in institutionalized education, who are generally peace-loving and receptive to the influence of foreign cultures to the point of suicide. There are other peoples, highly educated and steeped in classical culture, such as the Germans, who are generally nationalistic and warlike. The Athenians under Pericles and the Italians of the Renaissance created cultures not equalled in the history of Western civilization, and both were at least as nationalistic and warlike in that period of their history as at any time before or after.

Furthermore, in the history of some nations, such as the British and the French, periods of nationalistic exclusiveness and warlike policies alternate with cosmopolitan and peaceful ones, and no correlation exists between these changes and the development of education and culture. The Chinese people have a tradition of respect for learning superior to that of any other people, and they can look back upon a history of cultural attainments longer than any other and at least as creative. These high qualities of education and culture have made the Chinese look with contempt on the profession of the soldier as well as upon the members of all other nations which at the beginning of the nineteenth century were still regarded as barbarian vassals of the Chinese emperor. Yet they have not made the Chinese people less nationalistic and more peaceful. Russian education in our time has reached a higher level of achievement than ever before, especially in the fields of literacy and technical education. Its excellence has had no influence upon the receptiveness of the Russian people for foreign ideas nor upon the foreign policies of the Russian government. The Soviet Union is not even a member of UNESCO.

These examples taken at random show that the quantity and quality of education and culture as such is obviously irrelevant to the issue of a world community. That issue hinges not upon knowledge and upon the creation and appreciation of cultural values, but upon a moral and political transformation of unprecedented dimensions.

What has been said of education and culture as such holds true also of educational and cultural activities which aim at the interchange of the products of different national cultures. The existence of a multitude of interpersonal relations transcending national boundaries is no answer to our problem. More particularly, the existence of intellectual and esthetic ties across national boundaries proves nothing in favor of a world community. A world community with political potentialities is a community of moral standards and political action, not of intellect and sentiments. That an intellectual elite in the United States enjoys Russian music and literature and that Shakespeare has not been banned from the Russian stage has no relevance at all for the problem with which we are concerned. This sharing of the same intellectual and esthetic experiences by members of different nations does not create a society; for it does not create morally and politically relevant actions on the part of the members of different nations with respect to each other, which they would not have undertaken had they not shared in those experiences.

It should be remembered that on a much higher plane than the intel-

## *Politics among Nations*

lectual and the esthetic and with the objective of clearly defined action most members of most politically active nations have shared the same experiences for more than a thousand years. They have prayed to the same God, have held the same fundamental religious beliefs, have been bound by the same moral laws, and have had the same ritual symbols in common. That community of religious experiences, much more intimately related to the whole personality of the individual and to his actions than anything that supranational intellectual and esthetic experiences have to offer, was able to create an international community of sorts, but not an international community sufficiently integrated to make a world state possible. How, then, can we expect that the enjoyment of Tchaikovsky, the impact of Dostoevski, the insights of the *Federalist*, and the imagery of *Moby Dick*, which might be shared by all Americans and Russians alike, could create not only a fleeting community of feeling, but a community of moral valuations and political actions overthrowing old loyalties and establishing new ones?

To that question history has given an unmistakable answer. Cultural unity, much closer than anything UNESCO can plan and achieve, has coexisted with war in all periods of history. We are not speaking here of civil wars which by definition are fought by members of the same national culture. The wars among the Greek city states, the European wars of the Middle Ages, the Italian wars of the Renaissance, the religious wars of the sixteenth and seventeenth centuries, even the wars of the eighteenth century in so far as the elite was concerned, were fought within the framework of a homogeneous culture. These cultures had all essentials in common: language, religion, education, literature, art. Yet these cultures did not create a community coextensive with themselves, which could have kept disruptive tendencies in check and channeled them into peaceful outlets. How, then, can one expect that such a community will be created through interchange among cultures, so diverse in all the respects in which those historic ones were homogeneous?

Let us consider the third purpose of UNESCO: international understanding. It is here that the basic fallacy of UNESCO's conception of international affairs comes to the fore. International conflicts, so it is believed, are the result of an intellectual deficiency, of ignorance and lack of judgment as to the qualities of other peoples. If Americans could only come to understand the Russians, and vice versa, they would realize how much they are alike, how much they have in common, and how little they have to fight about. The argument is fallacious on two counts.

Individual experience, which anybody can duplicate at will, shows that increased friendship is not necessarily a concomitant of increased understanding. There are, of course, numerous instances in which A has misunderstood the character and the motives of B and in which clarification of the facts will remove the source of conflict. Such is not the case when A and B are engaged in a conflict in which their vital interests are at stake. A does not fight B for economic advantage because he misunderstands the intentions of B; it is rather because he understands them only too well. Many an American GI went to China full of sentimental friendship for the Chinese people whom he did not know. His friendly feelings did not survive the

## *The World Community*

shock of understanding. The similar experiences of many friendly visitors to Russia are too typical to need elaboration.

Among those who from the beginning were most firmly opposed to the foreign objectives of the Nazi regime, even at the risk of war, were some who had a profound understanding of German culture. It was exactly that understanding which made them implacable enemies of the Nazi regime. Similarly, the students of Russian history and culture, those who really understand Russia and the Russians, have as a rule been equally unaffected by the pro- and anti-Russian hysteria. They have known the traditional objectives of Russian expansionism as well as the traditional methods of Russian diplomacy. If their understanding had had an influence upon the conduct of foreign affairs in the Western democracies, that conduct would certainly have been more intelligent and successful than it actually was. Whether or not such understanding would have made for better relations with the Soviet Union is an open question. An intelligent and successful foreign policy depends upon the Americans' and the Russians' understanding what both nations are and want. Peace between the United States and the Soviet Union depends in the last analysis upon whether what one of them is and wants is compatible with what the other one is and wants.

This observation points up the other fallacy in UNESCO's conception of international affairs. In the conception that international conflicts can be eliminated through international understanding, there is implicit the assumption that the issues of international conflicts, born as they are of misunderstandings, are but imaginary and that actually no issue worth fighting about stands between nation and nation. Nothing could be farther from the truth. All the great wars which decided the course of history and changed the political face of the earth were fought for real stakes, not for imaginary ones. The issue in those great convulsions was invariably: Who shall rule and who shall be ruled? Who shall be free, and who, slave?

Was misunderstanding at the root of the issue between the Greeks and the Persians, between the Athenians and the Macedonians, between the Jews and the Romans, between emperor and pope, between the English and the French in the late Middle Ages, between the Turks and the Austrians, between Napoleon and Europe, between Hitler and the world? Was misunderstanding of the other side's culture, character, and intentions the issue, so that those wars were fought over no real issue at all? Or could it not rather be maintained that in many of these conflicts it was exactly the misunderstanding of the would-be conqueror's culture, character, and intentions which preserved peace for a while, whereas the understanding of these factors made war inevitable? So long as the Athenians refused to heed the warnings of Demosthenes, the threat of war remained remote. It was only when, too late for their salvation, they understood the nature of the Macedonian Empire and of its policies that war became inevitable. That correlation between understanding and the inevitability of conflict is one of the melancholy lessons which history conveys to posterity: The more thoroughly one understands the other side's position, character, and intentions, the more inevitable the conflict often appears to be.

Irrespective of its great intrinsic merits, the program of UNESCO is ir-

## *Politics among Nations*

relevant to the problem of the world community because its diagnosis of the bars to a world community so completely misses the point. The problem of the world community is a moral and political and not an intellectual and esthetic one. The world community is a community of moral judgments and political actions, not of intellectual endowments and esthetic appreciation. Let us suppose that American and Russian education and culture could be brought to the same level of excellence or completely amalgamated, and that Russians would take to Mark Twain as Americans would take to Gogol. If that were the case, the problem of who shall control the Dardanelles would still stand between the United States and the Soviet Union, as it does today. So long as men continue to judge and act in accordance with national rather than supranational standards and loyalties, the world community remains a postulate which still awaits its realization.

### 2. THE FUNCTIONAL APPROACH: THE SPECIALIZED AGENCIES OF THE UNITED NATIONS

How is such a transformation of standards and loyalties to be brought about? The specialized agencies of the United Nations have pointed a way. They are autonomous organizations, owing their existence to particular agreements among a number of states whose identity differs from agency to agency. They have their own constitutions, their own budgets, their own policy-making and administrative bodies, and each agency has a membership of its own. The names of some of these agencies are indicative of the functions they fulfill: International Labor Organization, Food and Agriculture Organization, International Bank for Reconstruction and Development, International Monetary Fund, International Trade Organization, International Telecommunication Union, Universal Postal Union, International Civil Aviation Organization, UNESCO, World Health Organization.

Chapters IX and X of the Charter of the United Nations provide for organizational and functional relations between the specialized agencies and the United Nations. The Charter stresses to a degree unknown in the history of international organization the responsibility of the United Nations for the rights and the well-being of the individual regardless of national affiliation. It has created in the Economic and Social Council a special organ for the discharge of that responsibility. The Economic and Social Council has the authority to conclude agreements—and has already done so in a number of instances—with the specialized agencies, “defining the terms on which the agency concerned shall be brought into relationship with the United Nations.”<sup>4</sup> The United Nations may “make recommendations for the coordination of the policies and activities of the specialized agencies.”<sup>5</sup> The Economic and Social Council may take steps to receive regular and special reports from the specialized agencies and may perform services at the request of members of the United Nations and of specialized agencies.<sup>6</sup>

<sup>4</sup> Article 63, paragraph 1.

<sup>5</sup> Article 58; see also Articles 62, 63, paragraph 2.

<sup>6</sup> Articles 64, 66, paragraph 2.

What is the philosophy underlying the social and economic activities which the specialized agencies are undertaking with the co-operation of the United Nations? What is the relevance of that philosophy for the problem of the international community? This question has been answered with great brilliance and persuasiveness by Professor Mitrany.

If the evil of conflict and war springs from the division of the world into detached and competing political units, will it be exorcised simply by changing or reducing the lines of division? Any political reorganization into separate units must, sooner or later, produce the same effects; any international system that is to usher in a new world must produce the opposite effect of subduing political division. As far as one can see, there are only two ways of achieving that end. One would be through a world state which would wipe out political divisions forcibly; the other is the way discussed in these pages, which would rather overlay political divisions with a spreading web of international activities and agencies, in which and through which the interests and life of all the nations would be gradually integrated. That is the fundamental change to which any effective international system must aspire and contribute: to make international government co-extensive with international activities. . . . It must care as much as possible for common needs that are evident, while presuming as little as possible upon a social unity which is still only latent and unrecognized. . . . [In that way] The community itself will acquire a living body not through a written act of faith but through active organic development. . . . That trend is to organize government along the lines of specific ends and needs, and according to the conditions of their time and place, in lieu of the traditional organization on the basis of a set constitutional division of jurisdiction of rights and powers. . . . The functional approach . . . would help the growth of such positive and constructive common work, of common habits and interests, making frontier lines meaningless by overlaying them with a natural growth of common activities and common administrative agencies.<sup>7</sup>

This is indeed the way in which communities grow and in which governments grow out of communities. We have already noted that sovereignty was a fact before it was a theory, and that the American people formed a community before they created a state. How, then, can a community be created where none exists?

We have quoted with approval Professor Mitrany's thesis that an international community must grow from the satisfaction of common needs which members of different nations share. The specialized agencies of the United Nations, serving peoples all over the world regardless of national boundaries, could create by the very fact of their existence and performance a community of interests, valuations, and actions. Ultimately, if such international agencies would be numerous enough and would serve the most important wants of most peoples of the earth, the loyalties to these institutions and to the international community of which they are the agencies would supersede the loyalties to the separate national societies and their institutions.

For proof that such a development is feasible under present world conditions, Professor Mitrany relies in the main upon the experiences which

<sup>7</sup> David Mitrany, *A Working Peace System* (London: The Royal Institute of International Affairs, 1944), pp. 6, 7, 10, 20, 26, 27. (Reprinted by permission of the author.)

## *Politics among Nations*

the Allies made during the Second World War with functional international agencies, such as the Anglo-American Raw Materials Board and the Middle East Supply Centre. These examples put in sharp focus the problem raised by the functional approach.

In war, the loyalties to the common cause and the common interest in victory over the common enemy overrode the separate national loyalties and made possible the successful operation of international functional agencies of major importance. In peace, what the nation has to offer the individual seems to outweigh by far the benefits to be derived from the functional agencies of an international character. More particularly, the conflicts of power which separate nations and the insecurity which they create make identification with the nation the overriding concern of most members of all nations. The nation offers the individual protection, vicarious gratification of power drives, and immediate satisfaction of material needs. With few sporadic exceptions, such as UNNRA, or the assistance of the World Health Organization in combating an epidemic, the specialized agencies of the United Nations offer hopes and satisfactions of a kind which is far removed from the direct experiences of ordinary people and may make itself felt only through the intermediary of a number of national agencies, so that its international origins are hard to trace. Who would think of giving thanks to the Universal Postal Union, when he mails a letter to a foreign country, for the contribution that international agency is making to such an operation?

Thus the contributions which international functional agencies make to the well-being of members of all nations fade into the background. What stands before the eyes of all are the immense political conflicts which divide the great nations of the earth and threaten the well-being of the loser, if not his very existence. This is not primarily a matter of false emphasis born of ignorance. It is rather the recognition of the undeniable fact that, from a functional point of view, what the national government does or does not do is much more important for the satisfaction of individual wants than what an international functional agency does or does not do. More important than anything else is the ability of the national government to defend its territory and citizens against foreign aggression and within its territory to maintain peace and keep in operation the processes of social change. The neglect with which the public treats international functional agencies is but the exaggerated reflection of the actual negligible role which these agencies play for the solution of the important international issues.

This is so when no conflict exists between the national interests of a particular nation and the objectives and operations of an international functional agency. In case of such conflict the national interest wins out over the international objective. Thus it is deeply significant that of the two great antagonists on the scene of contemporary world politics, one, the Soviet Union, traditionally fearful of foreign intervention and jealous of the integrity of its political and economic system, has joined none of the new specialized agencies, is collaborating only with one, the World Health Organization, and is a member of the two which have existed for the better part of a century and are the most unpolitical in character: the Universal Postal Union, established in 1874, and the International Telecommunication Union, which replaced the

International Telegraphic and Radiotelegraphic Unions of 1865 and 1912, respectively.

The answer to the question of how a world community can be created by way of the functional approach, then, lies in the sphere of international politics. We proposed that the first step toward the peaceful settlement of the international conflicts which might lead to war was the creation of an international community as foundation for a world state. We find that the creation of an international community presupposes at least the mitigation and minimization of international conflicts so that the interests which unite members of different nations may outweigh the interests which separate them. How can international conflicts be mitigated and minimized? This is the final question which calls for examination.



*PART TEN*

THE PROBLEM OF PEACE  
IN THE MID-TWENTIETH  
CENTURY: PEACE THROUGH  
ACCOMMODATION



## CHAPTER XXVIII

# *Diplomacy*

We have seen that international peace cannot be preserved through the limitation of national sovereignty, and we found the reasons for this failure in the very nature of the relations among nations. We concluded that international peace through the transformation of the present society of sovereign nations into a world state is unattainable under the moral, social, and political conditions which prevail in the world in our time. If the world state is unattainable in our world, yet indispensable for the survival of that world, it is necessary to create the conditions under which it will not be impossible from the outset to establish a world state. As the prime requisite for the creation of such conditions we suggested the mitigation and minimization of those political conflicts which in our time pit the two superpowers against each other and evoke the specter of a cataclysmic war. This method of establishing the preconditions for permanent peace we call peace through accommodation. Its instrument is diplomacy.)

### I. FOUR TASKS OF DIPLOMACY

We have already had occasion to emphasize the paramount importance of diplomacy as an element of national power. The importance of diplomacy for the preservation of international peace is but a particular aspect of the general function which diplomacy fulfills as an element of national power. For a diplomacy which ends in war has failed in its primary objective: the promotion of the national interest by peaceful means. This has always been so and is particularly so in view of the destructive potentialities of total war.

Taken in its widest meaning, comprising the whole range of foreign policy, the task of diplomacy is fourfold. (1) Diplomacy must determine its objectives in the light of the power actually and potentially available for the pursuit of these objectives. (2) Diplomacy must assess the objectives of other nations and the power actually and potentially available for the pursuit of these objectives. (3) Diplomacy must determine to what extent these different objectives are compatible with each other. (4) Diplomacy must employ the means suited to the pursuit of its objectives. Failure in any one of these tasks may jeopardize the success of a foreign policy and with it the peace of the world.

## *Politics among Nations*

1. A nation which sets itself goals which it has not the power to attain may have to face the risk of war on two counts. Such a nation is likely to dissipate its strength and not to be strong enough at all points of friction to deter a hostile nation from challenging it beyond endurance. The failure of its foreign policy may force the nation to retrace its steps and to redefine its objectives in view of its actual strength. Yet it is more likely that, under the pressure of an inflamed public opinion, such a nation will go forward on the road toward an unattainable goal, strain all its resources to achieve it, and finally, confounding the national interest with that goal, seek in war the solution to a problem which cannot be solved by peaceful means.

2. A nation will also invite war if its diplomacy wrongly assesses the objectives of other nations and the power at their disposal. We have already pointed to the error of mistaking a policy of the status quo for a policy of imperialism, and vice versa, and of confounding one kind of imperialism with another.<sup>1</sup> A nation which mistakes a policy of imperialism for a policy of the status quo will be unprepared to meet the threat to its own existence which the other nation's policy constitutes. Its weakness will invite attack and may make war inevitable. A nation which mistakes a policy of the status quo for a policy of imperialism will evoke through its disproportionate reaction the very danger of war which it is trying to avoid. For as A mistakes B's policy for imperialism, so B might mistake A's defensive reaction for imperialism, too. Thus both nations, each intent upon forestalling imaginary aggression from the other side, will rush to arms. Similarly, the confusion of one type of imperialism with another may call for disproportionate reaction and thus evoke the risk of war.

As for the assessment of the power of other nations, either to overrate or to underrate it may be equally fatal to the cause of peace. By overrating the power of B, A may prefer to yield to B's demands until, finally, A is forced to fight for its very existence under the most unfavorable conditions. By underrating the power of B, A may become overconfident in its assumed superiority. A may advance demands and impose conditions upon B which the latter is supposedly too weak to resist. Unsuspecting B's actual power of resistance, A may be faced with the alternative of either retreating and conceding defeat or of advancing and risking war.

3. A nation which wants to pursue an intelligent and peaceful foreign policy cannot cease comparing its own objectives and the objectives of other nations in the light of their compatibility. If they are compatible, no problem arises. If they are not compatible, nation A must determine whether its objectives are so vital to itself that they must be pursued despite that incompatibility with the objectives of B. If it is found that A's vital interests can be safeguarded without the attainment of these objectives, they ought to be abandoned. On the other hand, if A finds that these objectives are essential for its vital interests, A must then ask itself whether B's objectives, incompatible with its own, are essential for B's vital interests. If the answer seems to be in the negative, A must try to induce B to abandon its objectives, offer-

---

<sup>1</sup> See above, pp. 46 ff., 66 ff.

ing B equivalents not vital to A. In other words, through diplomatic bargaining, the give-and-take of compromise, a way must be sought by which the interests of A and B can be reconciled.

Finally, if the incompatible objectives of A and B should prove to be vital to either side, a way might still be sought in which the vital interests of A and B might be redefined, reconciled, and their objectives thus made compatible with each other. Here, however — even provided that both sides pursue intelligent and peaceful policies — A and B are moving dangerously close to the brink of war.

4. It is the final task of an intelligent diplomacy, intent upon preserving peace, to choose the appropriate means for pursuing its objectives. The means at the disposal of diplomacy are three: persuasion, compromise, threat of force. No diplomacy relying upon nothing but the threat of force can claim to be both intelligent and peaceful. No diplomacy which would stake everything on persuasion and compromise deserves to be called intelligent. Rarely, if ever, in the conduct of the foreign policy of a great power is there justification for using only one method to the exclusion of the others. Generally, the diplomatic representative of a great power, in order to be able to serve both the interests of his country and the interests of peace, must at the same time use persuasion, hold out the advantages of a compromise, and impress the other side with the military strength of his country.

The art of diplomacy consists in putting the right emphasis at any particular moment on each of these three means at its disposal. A diplomacy which has successfully discharged its other functions may well fail in advancing the national interest and preserving peace if it stresses persuasion when the give-and-take of compromise is primarily required by the circumstances of the case. A diplomacy which puts most of its eggs in the basket of compromise when the military might of the nation should be predominantly displayed, or which stresses military might when the political situation calls for persuasion and compromise will likewise fail.

## 2. INSTRUMENTS OF DIPLOMACY

The four tasks of diplomacy are the basic elements of which foreign policy consists everywhere and at all times. One might say that the chieftain of a primitive tribe maintaining political relations with a neighboring tribe will have to perform these four functions if he wants to be successful and to preserve peace. The need for the performance of these functions is as old and as widespread as international politics itself. Only the performance of these functions by organized agencies is of relatively recent origin.

The organized instruments of diplomacy are two: the foreign offices in the capitals of the respective countries, and the diplomatic representatives sent by the foreign offices to the capitals of foreign countries. The foreign office is the policy-forming agency, the brains of foreign policy where the impressions from the outside world are gathered and evaluated, where foreign policy is formulated, and where the impulses emanate which the diplo-

## *Politics among Nations*

matic representatives transform into actual foreign policy. While the foreign office is the brains of foreign policy, the diplomatic representatives are its eyes, ears, and mouth, its fingertips, and, as it were, its itinerant incarnations. The diplomat fulfills three basic functions for his government — symbolic, legal, and political.

### *a) Symbolic Representation*

The diplomat is first of all the symbolic representative of his country. As such he must continuously perform symbolic functions and expose himself to symbolic functions on the part of other diplomats and of the foreign government to which he is accredited. These functions serve to test, on the one hand, the prestige in which his country is held abroad and, on the other, the prestige with which his own country regards the country to whose government he is accredited. The American Ambassador in London will, for instance, represent the President of the United States at the official functions to which he is invited and at those which he gives, such as state dinners, receptions, and the like. He extends and receives congratulations and condolences upon occasions joyful or sad for the nations concerned. We have already discussed the symbolic functions of the diplomatic ceremonial.<sup>2</sup>

As a significant example of the symbolic function of diplomacy, mention may be made of the lavish entertainment which most diplomatic missions feel constrained to offer to the members of the government to which they are accredited, to their fellow diplomats, and to the high society of the capital where they reside. This custom, which has been the object of much adverse comment in democratic countries, is not primarily the expression of a love for luxury on the part of individual diplomats, but fulfills a special function in the scheme of diplomatic representation.

While entertaining, the diplomat does not act for himself as an individual, but as the symbolic representative of his country. It is the Russian Ambassador as such who invites guests to a reception in commemoration of the October Revolution of 1917. Through him (his identity is irrelevant for this symbolic purpose) it is the Soviet Union which entertains, celebrates, and tries to impress its guests — as well as those who pointedly have not been invited — with its wealth and generosity. It is not by accident that in the thirties, after the Soviet Union had regained an important, yet suspect position in the society of nations, the parties given by the Russian embassies throughout the world were famed for their lavishness and for the quantity and quality of food and drink. The purpose of this extravagance was not to show the bourgeois inhabitants of the Western world how well off the Russian people were. The purpose was rather to compensate for the political inferiority from which the Soviet Union had just barely escaped and into which it feared it might sink again. By instructing its diplomatic representatives to act in matters of entertainment as the equals, if not the betters, of their colleagues in foreign capitals, the Soviet Union — not unlike an upstart who has just crashed society — endeavored to demonstrate symbolically that it was at least as good a nation as any other.

<sup>2</sup> See above, pp. 50 ff.

*b) Legal Representation*

The diplomat also acts as the legal representative of his government. He is the legal agent of his government in the same sense in which a domestic corporation with its seat in Wilmington, Delaware, is represented by legal agents in other states and cities. These agents act in the name of that legal fiction which we call a corporation, make declarations binding upon it, sign contracts obligating it, and act within the limits of the corporate charter as though they were the corporation. Similarly, the American Ambassador in London performs in the name of the government of the United States the legal functions which the Constitution, the laws of the United States, and the orders of the government allow him to perform. He may be authorized to sign a treaty or to transmit and receive ratification documents by which a treaty already signed is brought into force. He gives legal protection to American citizens abroad. He may represent the United States at an international conference or in the General Assembly of the United Nations and cast his vote in the name, and according to the instructions, of his government.

*c) Political Representation*

The diplomat, together with the foreign office, shapes the foreign policy of his country. This is by far his most important function. As the foreign office is the nerve center of foreign policy, so are the diplomatic representatives its outlying fibers which maintain the two-way traffic between the center and the outside world.

Upon the diplomats' shoulders lies the main burden of discharging at least one of the four tasks of diplomacy discussed above: they must assess the objectives of other nations and the power actually and potentially available for the pursuit of these objectives. To that end they must inform themselves of the plans of the government to which they are accredited through direct interrogation of government officials and political leaders, through canvassing the press and other mouthpieces of public opinion. Furthermore, they must evaluate the potential influence upon governmental policies of opposing trends within the government, political parties, and public opinion.

A foreign diplomat in Washington must keep his government informed about the present and probable future attitude of the different branches of the United States government with regard to current problems of international affairs. He must appraise the importance for the development of foreign policy of different personalities in the government and the political parties. What stand are different presidential candidates likely to take with regard to the general and specific problems of foreign affairs in the event of their election? What is the influence of a certain columnist or radio commentator upon official policy and public opinion, and how representative of official thinking and of the trends in public opinion are his views? Such are some of the questions which the diplomat must try to answer. Upon the reliability of his reports and the soundness of his judgment the success or failure of the foreign policy of his government and its ability to preserve peace may well depend.

## *Politics among Nations*

When it comes to evaluating the actual and potential power of a nation, the diplomatic mission takes on the aspects of a high-class and *sub-rosa* spy organization. High-ranking members of the armed services are delegated to the different diplomatic missions where as military, naval, and air attachés they are responsible for accumulating, by whatever means are available, information about actual and planned armaments, new weapons, the military potential, military organization, and the war plans of the countries concerned. Their services are supplemented by commercial attachés who collect information about economic trends, industrial developments, and the location of industries, especially with regard to their bearing upon military preparedness. In this and many other respects too numerous to mention the accuracy and soundness of the reports which a government receives from its diplomatic missions abroad is indispensable for the soundness of its own decisions.

In this function of gathering information, especially secret information upon which the foreign policies of one's own country could be founded, lies the root of modern diplomacy. In the Middle Ages it was taken for granted that the special envoy of a prince traveling in a foreign country was a spy. When in the course of the fifteenth century the small Italian states started to make use of permanent diplomatic representatives in their relations with stronger states, they did so primarily for the purpose of receiving timely information of aggressive intentions on the part of the latter. Even when in the sixteenth century permanent diplomatic missions had become general, diplomats were widely regarded as a nuisance and a liability for the receiving state. At the beginning of the seventeenth century Hugo Grotius went so far as to advocate their abolition.

Diplomatic representatives are not only the eyes and the ears which report the events of the outside world to the nerve center of foreign policy as the raw material for its decisions. Diplomatic representatives are also the mouth and the hands through which the impulses emanating from the nerve center are transformed into words and actions. They must make the people among whom they live and especially the mouthpieces of their public opinion and their political leaders understand and, if possible, approve the foreign policy which they represent. For this task of "selling" a foreign policy, the personal appeal of the diplomat and his understanding of the psychology of the foreign people are essential prerequisites.

In the performance of the peace-preserving function of persuasion, negotiations, and threat of force, the diplomatic representative plays an outstanding part. His foreign office can give him instructions as to the objectives pursued and the means to be employed. Yet, for the execution of these instructions, it must rely upon the judgment and the skill of the diplomatic representative himself. The foreign office can tell its representative to use persuasion or to threaten force or to avail himself of both tactics simultaneously, but must leave it to the representative's discretion how and when to make use of those techniques. How persuasive an argument will be, what advantages a negotiated agreement will yield, what impression the threat of force will make, how effectively emphasis is placed upon one or the other of these techniques — all this lies in the hands of the diplomat who has it in his



power to bungle a good, and avoid the worst consequences of a bad, foreign policy. We have mentioned the spectacular contributions which great diplomatists have made to the power of their nations.<sup>1</sup> Their contributions to the cause of peace are no less important.

### 3. THE DECLINE OF DIPLOMACY

Today diplomacy no longer performs the role, often spectacular and brilliant and always important, which it has performed from the end of the Thirty Years' War to the beginning of the First World War. The decline of diplomacy set in with the end of the First World War. In the twenties, a few outstanding diplomatists were still able to make important contributions to the foreign policies of their countries. In the decade preceding the Second World War the part which diplomats took in shaping foreign policy became ever smaller, and this decline of diplomacy as a technique of conducting foreign affairs became more and more patent. Since the end of the Second World War, diplomacy has lost its vitality, and its functions have withered away to such an extent as is without precedent in the history of the modern state system. Five factors account for that decline.

#### *a) Development of Communications*

The most obvious of these factors is the development of modern communications. Diplomacy owes its rise in part to the absence of speedy communications in a period when the governments of the new territorial states maintained continuous political relations with each other. Diplomacy owes its decline in part to the development of speedy and regular communications in the form of the airplane, the radio, the telegraph, the teletype, the long-distance telephone.

When at any time before the First World War the governments of the United States and of Great Britain wanted to enter into negotiations, it was indispensable for them to have permanent representatives, endowed with a great deal of discretion, in London and Washington to carry on the negotiations. These permanent representatives were necessary because the facilities for transmitting rapidly and continuously detailed messages were cumbersome, and, more particularly, the time consumed by travel made personal consultations impossible without disrupting the negotiations. Today an official of the State Department needs only to converse over the trans-Atlantic telephone with his counterpart in the British Foreign Office or with the American Ambassador in London or board a trans-Atlantic plane in the afternoon to start negotiations in London the next morning. Whenever direct consultations with his government become necessary, a week end is all he needs to cross and recross the Atlantic, to inform his government of the latest developments, and to receive its instructions.

Only a quarter of a century ago it would have been unthinkable for the

---

<sup>1</sup> See above, pp. 106, 107:

## *Politics among Nations*

Secretary of State to absent himself from Washington for weeks in order to participate in person in a Pan-American conference. Today he remains in continuous contact with the State Department through telephone and radio, and an overnight trip will bring him back to Washington on a moment's notice. Thus it has become the rule that important negotiations are carried on not by diplomatic representatives, but by special delegates who may be the foreign ministers themselves or high officials of the foreign offices or technical experts.

### *b) Depreciation of Diplomacy*

These technological developments are, however, not solely responsible for the discard into which the traditional methods of diplomacy have fallen. To the technological ability to part with the services of diplomacy must be added the conviction that those services ought to be parted with because they not only contribute nothing to the cause of peace, but actually endanger it. This conviction grew in the same soil which nourished the conception of power politics as an accident of history to be eliminated at will.<sup>4</sup>

That conviction and this conception both recognize the intimate relation between power politics and the functions of diplomacy, and in this they are right. The emergence of diplomacy as an institution coincides with the rise of the national state and, hence, with the appearance of international relations in the modern sense. The contemporary emergence of diplomacy and the modern state system is, however, more than a mere coincidence. If there is to be intercourse at all among sovereign nations with the goal of creating and maintaining at least a modicum of order and peace in international affairs, that intercourse must be carried on by permanent agents. The opposition to, and depreciation of, diplomacy, then, is but a peculiar manifestation of hostility to the modern state system and the kind of international politics it has produced.

It is indeed true that the diplomat has been held morally in low esteem throughout modern history, and not only by those who thought that there was an easy way of eliminating the struggle for power from the international scene. The diplomat's reputation for deviousness and dishonesty is as old as diplomacy itself. Well known is the definition of a diplomat attributed to Sir Henry Wotton, an English ambassador of the beginning of the seventeenth century, as "an honest man sent abroad to lie for his country." When Metternich was informed of the death of the Russian ambassador at the Congress of Vienna, he is reported to have exclaimed: "Ah, is that true? What may have been his motive?"

The modern version of that depreciation of diplomacy attaches special importance to one particular aspect of the diplomatic technique: its secrecy. During and after the First World War, wide currency was given to the opinion that the secret machinations of diplomats shared a great deal, if not the major portion, of responsibility for that war, that the secrecy of diplomatic negotiations was an atavistic and dangerous residue from the aristocratic past, and that international negotiations carried on and concluded under the

---

<sup>4</sup> See above, pp. 15 ff.

watchful eyes of a peace-loving public opinion could not but further the cause of peace.

Woodrow Wilson was the most eloquent spokesman of this new philosophy of international affairs. The Preamble to and the first of his Fourteen Points are still the most eloquent statement of the new philosophy. The Preamble to the Fourteen Points states: "It will be our wish and purpose that the processes of peace, when they are begun, shall be absolutely open, and that they shall involve and permit henceforth no secret understandings of any kind. The day of conquest and aggrandizement is gone by; so is also the day of secret covenants entered into in the interest of particular governments, and likely at some unlooked-for moment to upset the peace of the world. It is this happy fact, now clear to the view of every public man whose thoughts do not still linger in an age that is dead and gone, which makes it possible for every nation whose purposes are consistent with justice and the peace of the world to avow, now or at any other time, the objects it has in view." The first point reads: "Open covenants of peace, openly arrived at, after which there shall be no private international understandings of any kind, but diplomacy shall proceed always frankly and in the public view."<sup>5</sup>

### *c) Diplomacy by Parliamentary Procedures*

It was in deference to this new philosophy that after the First World War the statesmen of the world began to depart from the established pattern of diplomacy. They created in the League of Nations and later in the United Nations a new type of diplomatic intercourse: diplomacy by parliamentary procedure. International problems requiring solution are put on the agenda of the deliberative bodies of these organizations. The delegates of the different governments discuss the merits of the problem in public debate. A vote taken in accordance with the constitution of the organization disposes of the matter.

This method had been employed before by special conferences, such as the Hague Peace Conferences of 1899 and 1907. As an over-all method of dealing with international problems it was for the first time employed by the League of Nations. Its use by that organization was, however, apparent rather than real. The public discussions of the Council and the Assembly of the League were as a rule carefully rehearsed, especially when political matters were under consideration. A solution to which all could agree was generally sought and often found by the traditional means of secret negotiations which preceded the public meetings. The latter, then, simply gave the delegates of the nations concerned an opportunity of restating their positions for public consumption and of ratifying, in compliance with the provisions of the Covenant, the agreement secretly reached.

The United Nations, on the contrary, has taken seriously the parliamentary methods of transacting the business of diplomacy. Secret contacts for the purpose of reaching negotiated agreement have certainly been fewer be-

---

<sup>5</sup> Albert Bushnell Hart, editor, *Selected Addresses and Public Papers of Woodrow Wilson* (New York: Boni and Liveright, Inc., 1918), pp. 247-8.

## *Politics among Nations*

tween the opposing sides in the Security Council — the Eastern and Western bloc — than they are normally between Republicans and Democrats in Congress. Diplomatic negotiations of the traditional type have been limited to a minimum and, in so far as the East and the West are concerned, may now be said to have become virtually obsolete. An issue, such as the Greek, Spanish, or Iranian question, is put on the agenda, publicly debated, and voted on. The new diplomacy of the United Nations comes closest to the traditional methods of negotiation in the deliberations of some of the semisecret or secret committees which sometimes investigate facts or prepare solutions for the Security Council and the General Assembly. Generally, however, the new diplomacy leads to a vote in one of the deliberative agencies of the United Nations. It is a vote at which its processes aim and in which they culminate.

The trend toward public parliamentary procedures instead of traditional diplomatic negotiations, for which the operations of the Security Council of the United Nations are typical, has also affected the postwar international conferences which by composition, issues, and objectives most closely resemble the diplomatic gatherings of the nineteenth and early twentieth centuries. The Paris Peace Conference of 1946, attended by twenty-one nations, operated in the full light of publicity and duplicated in its procedures the pattern established by the deliberative agencies of the United Nations. The Foreign Ministers' Conferences, composed of the foreign ministers of France, Great Britain, the Soviet Union, and the United States, have debated and voted either in full public view or behind the transparent screen of semisecrecy which allowed the public to follow the main phases of the debate as reported by the different delegations to the correspondents of the press.

It is not only from the more spectacular negotiations between the East and the West that the traditional methods of diplomacy have virtually disappeared. The same is true of the day-by-day operations of the diplomatic missions of the United States and the other Western nations, on the one hand, and of the Soviet Union and its friends, on the other. The ease of communications, the condemnation of secret diplomacy, and the new parliamentary diplomacy cannot fully account for this over-all disintegration of diplomacy. Two additional factors must share responsibility for this decline: the peculiarly untraditional approach of the two superpowers to the issues of international politics, and the very nature of world politics in the mid-twentieth century.

### *d) The Superpowers: Newcomers in Diplomacy*

In its formative years the United States benefited from the services of an unusually brilliant diplomacy. From the Jacksonian era on the eminent qualities of American diplomacy disappeared as the need for them seemed to disappear. When the need for an active American foreign policy became manifest in the late 1930's, there was nothing to build on but a mediocre foreign service, the condemnation of power politics and of secret diplomacy transformed into moral indignation at "aggressor nations," and the tradition of the big stick which had worked so well in the Western Hemisphere. Thus

it was the improvisations of President Roosevelt alone, guided by an intuitive grasp of the international realities, which kept American foreign policy in tune with American interests.

In that decisive period neither the Secretary of State nor the permanent staff of the State Department nor the diplomatic representatives abroad exerted more than a subordinate influence upon the conduct of American foreign policy. When Roosevelt, who for twelve years had almost single-handedly made American foreign policy, left the scene, there was no man or group of men who were capable of creating and operating that intricate and subtle machinery by which traditional diplomacy had given peaceful protection and furtherance to the national interest. There remained only the instruments of diplomacy which had existed and were barely sufficient under the conditions of actual isolation. To it was now added the ascendancy of the military in international affairs.

For quite different reasons—three in number—the Soviet Union has failed to develop adequate instruments for diplomatic intercourse. The Bolshevik Revolution of 1917 destroyed the Russian diplomatic service which could look back upon a long tradition and had a number of brilliant achievements to its credit. The few old-school diplomats who were retained in office after the Revolution and the new diplomats of talent who rose from the ranks of the revolutionaries had little opportunity to prove themselves. The hostility between the Soviet Union and most other nations and the resulting isolation of the Soviet Union prevented the conduct of normal diplomatic relations.

Furthermore, official Russian philosophy considers such relations only as a temporary expedient, not as the normal and permanent way of carrying on relations with capitalistic states. It believes in the inevitability of the breakdown of capitalistic societies. This breakdown, it claims, will come about either spontaneously or through revolution. The Russian diplomat as the exponent of this philosophy is first of all the instrument of the historic process, the unfolding of which he may retard or facilitate, but which it is beyond his power to change. It is his mission to lend his support to the revolutionary forces in foreign countries, which are conscious of the predetermined course of history and are willing to help it along.

For a diplomat of this kind the traditional business of diplomacy is bound to be incidental to the larger issue of the historic process which, with socialism established everywhere, will ultimately make diplomacy itself superfluous. The best he can be striving for in his diplomatic dealings is a *modus vivendi* which he hopes and expects and his partners fear will not last forever. In the hands of such diplomacy, persuasion, negotiation, and the threat of force are at best temporary expedients. Diplomacy itself is little more than a stop-gap designed for a transition period before the final cataclysm ushers in universal socialism and with it permanent peace.

The Russian diplomat is the emissary of a totalitarian country which punishes failure or even too much discretion in interpreting official orders with loss of office and worse. In consequence, post-Revolutionary Russian diplomats have traditionally—and more than ever since the conclusion of the Second World War—conceived of their task as the transmission of the pro-

## *Politics among Nations*

posals of their government which other governments might accept or reject as they see fit. Counterproposals and other new elements in the negotiations call for new instructions from the foreign office. The content of these new instructions is again submitted to the other governments which may take it or leave it, and so forth, until the patience of one or the other or of all parties is exhausted. Such a procedure destroys all the virtues of diplomatic negotiations, such as quick adaptation to new situations, clever use of a psychological opening, retreat and advance as the situation may require, persuasion, the *quid pro quo* of bargaining, and the like. Diplomatic intercourse, as practiced by the new Russian diplomacy, resembles nothing so much as a series of military orders relayed from the high command, the foreign office, to the field commanders, the diplomatic representatives, who in turn communicate the terms of surrender to the enemy.

A diplomat whose main concern must be to retain the approval of his superiors is usually only too eager to report what the latter would like to hear rather than the truth. This tendency to bend the truth to the wishes of the foreign office and to paint the facts in favorable colors is found in all diplomatic services. With the Russian it is bound to become almost an obsession; for compliance gives at least temporary security in office.

Thus the weakness of American diplomacy is compounded by the vices of the Russian diplomatic system, and their coincidence goes a long way in explaining the virtual disappearance of normal diplomatic relations between the United States and the Soviet Union.

### *e) The Nature of Contemporary World Politics*

What is lacking in this explanation of the decline of diplomacy in our time is supplied by the very nature of contemporary world politics. Imbued with the crusading spirit of the new moral force of nationalistic universalism and both tempted and frightened by the potentialities of total war, two superpowers, the centers of two gigantic power blocs, face each other in inflexible opposition. They cannot retreat without giving up what they consider vital to them. They cannot advance without risking combat. Persuasion, then, is tantamount to trickery, compromise means treason, and the threat of force spells war.

Given the nature of the power relations between the United States and the Soviet Union and given the state of mind which these two superpowers bring to bear upon their mutual relations, diplomacy has nothing with which to operate and must of necessity become obsolete. Under such moral and political conditions, it is not the sensitive, flexible, and versatile mind of the diplomat, but the rigid, relentless, and one-track mind of the military which guides the destiny of nations. The military mind knows nothing of persuasion, of compromise, and of threats of force which are meant to make the actual use of force unnecessary. He knows only of victory and of defeat and of the concentration of a maximum of force at the enemy's weakest point.

If war were inevitable this book might end here. If war is not inevitable the conditions for the revival of diplomacy and for its successful operation in the service of peace remain to be considered.

## CHAPTER XXIX

# *The Future of Diplomacy*

### I. HOW CAN DIPLOMACY BE REVIVED?

[The revival of diplomacy requires the elimination of the factors, or at least of some of their consequences, which are responsible for the decline of the traditional diplomatic practices.] Priority in this respect belongs to the depreciation of diplomacy and its corollary: diplomacy by parliamentary procedures. In so far as that depreciation is only the result of the depreciation of power politics, what we have said about the latter should suffice for the former.<sup>1</sup> [Diplomacy, however morally unattractive its business may seem to many, is nothing but a symptom of the struggle for power among sovereign nations which try to maintain orderly and peaceful relations among themselves. If there were a way of banning the struggle for power from the international scene, diplomacy would disappear of itself. If order and anarchy, peace and war were matters of no concern to the nations of the world, they could dispense with diplomacy, prepare for war, and hope for the best. If nations who are sovereign, who are supreme within their territories with no superior above them, want to preserve peace and order in their relations, they must try to persuade, negotiate, and exert pressure upon each other. That is to say, they must engage in, cultivate, and rely upon diplomatic procedures.]

The new parliamentary diplomacy is no substitute for these procedures. On the contrary, it tends to aggravate rather than mitigate international conflicts and leaves the prospect for peace dimmed rather than brightened. Three essential qualities of the new diplomacy are responsible for these unfortunate results: its publicity, its majority votes, its fragmentation of international issues.

#### *a) The Vice of Publicity*

This is not the place to enter into an exhaustive discussion of the problem of secret diplomacy. It may suffice to note that there is a vast distinction between "open covenants" and "covenants openly arrived at," between publicity for the results of diplomatic negotiations and publicity for the diplomatic negotiations themselves. It takes only common sense derived from daily experience to realize that it is impossible to negotiate in public on any-

<sup>1</sup> See above, pp. 15 ff.

## *Politics among Nations*

thing in which parties other than the negotiators are interested. This impossibility derives from the very nature of negotiation and from the social context in which negotiations generally operate.

[It is a common characteristic of negotiations that they are started by each side with maximum demands which are whittled down in a process of persuasion, bargaining, and pressures until both sides meet on a level below the one from which they started.] The saving grace of negotiations is the result which satisfies the demands of either side at least up to a point, and which tends to strengthen amity between the parties by demonstrating in the act of agreement the existence of identical or complementary interests binding them together. On the other hand, the process leading up to the result reveals the parties in roles in which they would rather not be remembered by their fellows. There are more edifying spectacles than the bluffing, blustering, haggling, and deceiving, the real weakness and pretended strength, which go with horse-trading and the drive for a bargain. [To publicize such negotiations is tantamount to destroying, or at least impairing, the bargaining position of the parties in any further negotiations in which they might be engaged with other parties.]

[Not only will their bargaining position suffer. Their social status, their prestige, and their power will face irreparable damage if publicity attends these negotiations, uncovering their weakness and unmasking their pretenses. Competitors for the gains which the negotiators seek will take advantage of what the public negotiations have revealed to them.] They will do so not only in further negotiations with the parties, but also in their over-all calculations, plans, and dispositions, which take into account the qualities and potentialities of all participants in the competition.

It is for these reasons that in a free market no seller will carry on public negotiations with a buyer; no landlord with a tenant; no institution of higher learning with its staff. No candidate for office will negotiate in public with his backers, no public official with his colleagues, no politician with his fellow politicians. How, then, are we to expect that nations are able and willing to do what no private individual would think of doing? [The disadvantage to which nations would be put by the publicity of their negotiations is further increased by two factors.]

[On the one hand, the audience witnessing the spectacle of public international negotiations comprises not only a limited number of interested parties, but the whole world, which will enter in the annals of history what it has seen and heard. On the other hand, the governments concerned negotiate under the watchful eyes of their own peoples and especially, when they are democratically elected, in full view of the opposition. No government which wants to stay in power or simply retain the respect of its people can afford to give up publicly part of what it had declared at the outset to be just and necessary, to retreat from a position initially held, to concede at least the partial justice of the other side's claims.] Heroes, not horse-traders, are the idols of public opinion. Public opinion, while dreading war, demands that its diplomats act as heroes who do not yield in the face of the enemy even at the risk of war, and condemns as weaklings and traitors those who yield, albeit only half-way, for the sake of peace.



## *The Future of Diplomacy*

(In consequence, public diplomacy has not led to negotiation, nor has it solved any of the problems which threaten the peace of the world. Seated on a stage with the world as their audience, the delegates have been speaking to the world rather than to each other. Their aim has been not to persuade each other that they could find common ground for agreement, but to persuade the world and especially their own nations that they were right and the other side wrong and that they were and always will remain staunch defenders of the right.)

No man who has taken such a stand before the attentive eyes and ears of the world can in full public view agree to a compromise without looking like a fool and a knave. He must take himself at his public word and must stand unyieldingly "on principle," the favored phrase of public diplomacy, rather than on negotiation and compromise. He must defend the position initially taken, and so must the other side. Neither side being able to retreat or advance, a phony war of positions ensues. Both sides oppose each other inflexibly, each side knowing that the other will not and cannot move. To offer the public some semblance of activity, they fire empty shells of words into the air which explode noisily and, as everybody knows, are aimed at nothing. It is only in mutual vituperation that the minds of the delegates meet. When the delegates finally part, embittered and frustrated, they reach, however indignantly, an agreement of sorts at least on one point: the other side has engaged in propaganda. It so happens that on this point both sides are right.

This degeneration of diplomatic intercourse into a propaganda match is, then, the inevitable concomitant of the publicity of the new diplomacy. Not only is a publicly conducted diplomacy unable to reach agreement or even to negotiate for the purpose of reaching agreement, but each public meeting leaves international matters in a worse state than it encountered. For each propaganda match strengthens the conviction of the different delegates and of their nations that they are absolutely right and that the other side is absolutely wrong and that the gap separating them is too deep and wide to be bridged by the traditional methods of diplomacy.

### *b) The Vice of Majority Decision*

(The evil wrought by the public conduct of diplomacy is compounded by the attempt at deciding issues by majority vote. In the Security Council of the United Nations this method has developed into the tradition of nine members voting down two, the Soviet Union and one of its friends.) (That this method of conducting the business of diplomacy has solved no single issue is obvious from the results.) For instance, the Soviet Union was voted down several times on the Greek issue, but the votes in the Security Council were certainly irrelevant for whatever progress has been made toward the settlement of that issue. When the Security Council had to dispose of motions to take measures against the Franco regime in Spain, the Soviet Union found itself continuously outvoted. What has or has not been done concerning that issue has obviously no relation to those votes. The reason why voting-down an opponent in a deliberative international body is a useless and even a mischievous

## *Politics among Nations*

undertaking is to be found in the very nature of international society in contrast to national societies.

When the Congress of the United States votes down a minority, it actually decides the issue for the time being. It is able to do so for four reasons, all of which are absent on the international scene.

1. The parliamentary majority vote is an integral part of a whole system of devices for peaceful change, each being able to operate in supplementation or support of, or as a corrective upon, the others, and all limited and coordinated by the Constitution. The minority and the majority in Congress make up an integrated society. Aside from deliberative bodies deciding by majority vote, the national society has created a series of devices, such as the presidential veto and judicial review, by which the majority vote can be overriden and the minority can be protected against illegal use and arbitrary misuse of the majority vote. Behind a majority decision as well as behind the defeated minority stands the whole moral and political power of the national community, ready to enforce a decision of the majority and to protect the minority against injustice and abuse.

2. The instrumentalities of peaceful change which operate within the national community give the minority a chance to become a majority sometime in the future. That chance is inherent in the device of periodical elections and in the dynamics of the social process, which produce ever new alignments and new distributions of power. These dynamics also see to it that a minority in a deliberative assembly is never a minority in all the respects important to it. A group may be a religious minority, outvoted in issues of this kind, but may be part of the economic majority determining economic legislation, and so forth.

3. The numerical relation between minority and majority is at least an approximation to the actual distribution of power and interests within the whole population. When the House of Representatives votes a motion down 270 to 60, that is, 9 to 2, it is generally safe to assume that only a relatively small minority of the American people is identified with the defeated measure.

4. While in Congress each vote cast counts for one, it is, of course, true, politically speaking, that all votes are not of equal weight. The negative vote of a powerful committee chairman, industrialist, farmer, or labor leader with respect to a piece of legislation affecting the interests of their respective groups may well have a bearing upon the political, economic, or social consequences which the majority intended the piece of legislation to have. Yet even the most powerful single vote in Congress represents but a small fraction of the total power of the American people.

None of these four factors which make possible the contribution of the majority vote to domestic peaceful change operates on the international scene.

1. The majority vote in the Security Council, in particular, is the sole device for compulsory peaceful change within the framework of the United Nations. There is no constitution, no presidential veto, no compulsory judicial review, no bill of rights, imposing substantive and procedural restraints upon the majority and protecting the minority against injustice and abuse. Nor is there a community imposing moral restraints upon majority and mi-

## *The Future of Diplomacy*

nority alike and able to enforce the decision of the majority against a recalcitrant minority. The majority can outvote the minority as often as it wants to and on any issue it chooses, and the minority can protect itself with the veto against any majority decision which it wants to annul.

2. A minority in the Security Council is always likely, especially under present political conditions, to be a permanent one. For the same reasons, its minority status is bound to extend to all questions of major importance. The two-bloc system which dominates contemporary world politics leads to permanent alignments on either side of the divide. The tension between the two blocs makes virtually all issues political ones. When such issues come to a vote, the adherents of the two blocs are likely to split along the line separating the two blocs.

3. The numerical relation between the minority of two and the majority of nine obviously does not in any sense correspond to the actual distribution of power and interests among the members of the United Nations, nor does the vote of the most powerful members of the Security Council represent a relatively small fraction of the total power of the community of nations. On the contrary, the division of nine to two in the Security Council comes close to representing a division of, let us say, nine to seven, so far as the actual power of the members of the United Nations aligned on one or the other side is concerned. And the vote of the United States or the Soviet Union comes close to representing one-third of the total power of all members of the United Nations.

To outvote a powerful minority in a deliberative international agency, then, does not fulfill a useful purpose. For the minority cannot accept the decision of the majority, and the majority cannot enforce its decision short of war. At best, parliamentary procedures transferred to the international scene leave things as they are; they leave problems unsolved and issues unsettled. At worst, however, these procedures poison the international atmosphere and aggravate the conflicts which carry the seeds of war. They provide a majority with an opportunity to humiliate the minority in public and as often as it wishes. In the form of the veto, the corollary of the majority vote in a society of sovereign nations, these procedures provide the minority with a weapon with which to obstruct the will of the majority and to prevent the international agency from functioning at all. Neither the majority nor the minority needs to use self-restraint nor be aware of its responsibility to the international organization or to humanity, since what either side votes for or against cannot influence the course of events. For one group of sovereign nations to vote down another group of sovereign nations is, then, to engage in a puerile game which can accomplish nothing, but may well lead further on the road to war.

### *2) The Vice of Fragmentation*

The decision by majority vote implies the third of the vices of the new diplomacy which stands in the way of a revival of the traditional diplomatic practices: the fragmentation of international issues. By its very nature, the majority vote is concerned with an isolated case. The facts of life to be dealt

## *Politics among Nations*

with by the majority decision are artificially separated from the facts which precede, accompany, and follow them, and are transformed into a legal "case" or a political "issue" to be disposed of as such by the majority decision. In the domestic field, this procedure is not necessarily harmful. Here the majority decision of a deliberative body operates within the context of an intricate system of devices for peaceful change, supplementing, supporting, or checking each other as the case may be, but in any case attuned to each other in a certain measure and thus giving the individual decisions coherence with each other and with the whole social system.

[On the international scene, no such system of integrating factors exists. Consequently, it is here particularly inadequate to take up one "case" or "issue" after the other and to try to dispose of them by a succession of majority votes.] A case or issue, such as the Greek or Palestinian, is always a particular phase and manifestation of a much larger situation. Such a case or issue is rooted in the historic past and extends its ramifications beyond its particular locale and into the future. Our discussion of the relations between disputes and tensions has given us an indication of the intimate relations which exist between the surface phenomena of international conflicts and those large and undefined problems, buried deep under the surface of the daily occurrences of international life.<sup>2</sup> To deal with cases and issues as they arise and to try to dispose of them according to international law or political expediency is to deal with surface phenomena and leave the underlying problems unconsidered and unsolved. The League of Nations fell victim to that vice; the United Nations, heedless of the League's example, has not only erected it into a principle, but has developed it into a fine art.

For instance, there is no doubt that the League of Nations was right, according to international law, in expelling the Soviet Union in 1939 because of its attack upon Finland. But the political and military problems with which the Soviet Union confronted the world neither began with its attack on Finland nor ended there; it was unwise for the League to pretend that such was the case and to decide the issue on that pretense. History has proved the un-wisdom of that pretense; for only Sweden's refusal to allow British and French troops to pass through Swedish territory in order to come to the aid of Finland saved Great Britain and France from being at war with Germany and the Soviet Union at the same time. Whenever the League of Nations endeavored to deal with political situations presented as legal issues, it could deal with them only as isolated cases according to the applicable rules of international law, not as particular phases of an over-all political situation which required an over-all solution according to the rules of the political art. Hence, political problems were never solved but only tossed about and finally shelved according to the rules of the legal game.

What was true of the League of Nations has already proved to be true of the United Nations. In its approach to the Greek, Syrian, Indonesian, Iranian, Spanish, and Palestinian situations, the Security Council has remained faithful to the tradition established by the Council of the League of Nations. These cases have provided opportunities for exercise in parliamen-

---

<sup>2</sup> See above, pp. 343 ff.

## *The Future of Diplomacy*

tary procedure and for just that chicanery for which traditional diplomacy has so often been reproached, but on no occasion has even an attempt been made to face the political issues of which these situations are the surface manifestations.

The special political conferences of the postwar period have repeated the pattern of fragmentation established by the League of Nations and the United Nations. They have dealt with the issue of Korca, the Austrian peace treaty, German reparations, or the Marshall Plan. None of these conferences has faced the problem of which all these issues are particular phases and manifestations and upon whose solution the settlement of these issues depends: the problem of the over-all relations between the United States and the Soviet Union. Since they were unwilling to come to grips with the fundamental problem of international politics, they were unable to settle any of the particular issues to which they alone paid attention.

(This failure of the new diplomacy even to see the problem upon whose solution the preservation of peace depends, let alone to try to solve it, is the inevitable result of the methods which it has employed. A diplomacy which, instead of speaking in conciliatory terms to the other side, addresses the world for purposes of propoganda; which, instead of negotiating with compromise as its goal, strives for the cheap triumph of futile majority decisions and of obstructive vetoes; which, instead of facing the primary problem, is satisfied with manipulating the secondary ones — such a diplomacy is a liability rather than an asset for the cause of peace.)

(These three essential vices of the new diplomacy are aggravated by the misuse to which the ease of modern communications is put in international affairs. The conquest of time and space by modern technology has inevitably reduced the importance of diplomatic representation. Yet it has by no means made necessary the confusion of functions between the foreign office and diplomatic representation, which is characteristic of contemporary diplomacy.)

A secretary of state or foreign minister is physically able to converse with any foreign capital within a few minutes' time by way of telecommunications and to reach it in person within a few days at the most. Thus the tendency has grown, and it has become a habit in the American foreign service, for the men responsible for the conduct of foreign affairs to assume the role of roving ambassadors, hurrying from one conference to another, stopping in between conferences for a short while at the foreign office, and using their time there in preparation for the next meeting. The men who are supposed to be the brains of diplomacy, its nerve center, fulfill at best the functions of the nerve ends. In consequence, there is a void at the center. There is nobody who faces the over-all problem of international politics and sees all the particular issues as phases and manifestations of the whole. Instead, each specialist in the foreign office deals with the particular problems belonging to his specialty, and the fragmentation of the conduct of foreign affairs to which the techniques of the new diplomacy lend themselves is powerfully supported by the lack of an over-all direction of foreign affairs.

In addition, the same lack provides a standing invitation to other agencies of the government to fill the void. Thus the ascendancy of the military in the conduct of foreign affairs, especially in the United States, results in

## *Politics among Nations*

good measure from the default of the civilian authorities to provide over-all leadership in the field of foreign policy.

### 2. THE PROMISE OF DIPLOMACY: ITS EIGHT RULES<sup>a</sup>

[Diplomacy could revive itself if it would part with these vices which in recent years have well-nigh destroyed its usefulness and restore the techniques which controlled the mutual relations of states before the First World War. By doing so, however, diplomacy would realize only one of the preconditions for the preservation of peace. The contribution of a revived diplomacy to the cause of peace would depend upon the methods and purposes of its use.] The discussion of these uses is the last task which we have set ourselves in this book.

[We have already formulated the four main tasks with which a foreign policy must cope successfully in order to be able to promote at the same time the national interest and preserve peace. It remains for us now to reformulate those tasks in the light of the special problems with which contemporary world politics confronts diplomacy. We have seen that the two-bloc system, which is the dominant and distinctive element of contemporary world politics, carries with it potentialities for enormous evil and enormous good.] We have quoted the French philosopher Fénelon to the effect that the opposition of two approximately equal nations constitutes the ideal system of the balance of power, provided that the preponderant nation uses its power with moderation and "for the sake of public security." We found that the beneficial results which Fénelon expected from the two-bloc system have failed to attend the opposition between the United States and the Soviet Union, and that the potentialities for evil seem to have a better chance to materialize than those for good.<sup>4</sup>

[Finally, we saw the main reason for this threatening aspect of contemporary world politics in the character of modern war which has changed profoundly under the impact of nationalistic universalism and modern technology. The effects of modern technology cannot be undone. The only variable which remains subject to deliberate manipulation is the new moral force of nationalistic universalism.] The attempt to reverse the trend toward war through the technique of a revived diplomacy must start with this phenomenon. That means in negative terms that a revived diplomacy will have a chance to preserve peace only when it is not used as the instrument of a political religion aiming at universal dominion.

---

<sup>a</sup> We by no means intend to give here an exhaustive account of rules of diplomacy. We propose to discuss only those which seem to have a special bearing upon the contemporary situation.

<sup>4</sup> See above, pp. 285, 286.

## *The Future of Diplomacy*

### *a) Four Fundamental Rules*

1. *Diplomacy must be divested of the crusading spirit.* This is the first of the rules which diplomacy can neglect only at the risk of war. In the words of William Graham Sumner:

If you want war, nourish a doctrine. Doctrines are the most frightful tyrants to which men ever are subject, because doctrines get inside of a man's own reason and betray him against himself. Civilized men have done their fiercest fighting for doctrines. The reconquest of the Holy Sepulcher, "the balance of power," "no universal dominion," "trade follows the flag," "he who holds the land will hold the sea," "the throne and the altar," the revolution, the faith — these are the things for which men have given their lives. . . . Now when any doctrine arrives at that degree of authority, the name of it is a club which any demagogue may swing over you at any time and apropos of anything. In order to describe a doctrine, we must have recourse to theological language. A doctrine is an article of faith. It is something which you are bound to believe, not because you have some rational grounds for believing it is true, but because you belong to such and such a church or denomination. . . . A policy in a state we can understand; for instance, it was the policy of the United States at the end of the eighteenth century to get the free navigation of the Mississippi to its mouth, even at the expense of war with Spain. That policy had reason and justice in it; it was founded in our interests; it had positive form and definite scope. A doctrine is an abstract principle; it is necessarily absolute in its scope and abstruse in its terms; it is a metaphysical assertion. It is never true, because it is absolute, and the affairs of men are all conditioned and relative. . . . Now to turn back to politics, just think what an abomination in statecraft an abstract doctrine must be. Any politician or editor can, at any moment, put a new extension on it. The people acquiesce in the doctrine and applaud it because they hear the politicians and editors repeat it, and the politicians and editors repeat it because they think it is popular. So it grows. . . . It may mean anything or nothing, at any moment, and no one knows how it will be. You accede to it now, within the vague limits of what you suppose it to be; therefore, you will have to accede to it tomorrow when the same name is made to cover something which you never have heard or thought of. If you allow a political catchword to go on and grow, you will awaken some day to find it standing over you, the arbiter of your destiny, against which you are powerless, as men are powerless against delusions. . . . What can be more contrary to sound statesmanship and common sense than to put forth an abstract assertion which has no definite relation to any interest of ours now at stake, but which has in it any number of possibilities of producing complications which we cannot foresee, but which are sure to be embarrassing when they arise!<sup>5</sup>

The religious wars have shown that the attempt to impose one's own religion as the only true one upon the rest of the world is as futile as it is costly. A century of almost unprecedented bloodshed, devastation, and barbarization was needed to convince the contestants that the two religions could live together in mutual toleration. The two political religions of our time have taken the place of the two great Christian denominations of the sixteenth and seventeenth centuries. Will the political religions of our time need the lesson

<sup>5</sup> "War." *Essays of William Graham Sumner* (New Haven: Yale University Press, 1934), I, pp. 169 ff.

## *Politics among Nations*

of the Thirty Years' War, or will they rid themselves in time of the universalistic aspirations which inevitably lead to inconclusive war?

Upon the answer to that question depends the cause of peace. For only if it is answered in the affirmative can a moral consensus, emerging from shared convictions and common values, develop—a moral consensus within which a peace-preserving diplomacy will have a chance to grow. Only then will diplomacy have any chance to face the concrete political problems which require peaceful solution. If the objectives of foreign policy are not to be defined in terms of a world-embracing political religion, how are they to be defined? This is the most fundamental problem to be solved once the crusading aspirations of nationalistic universalism have been discarded.

2. *The objectives of foreign policy must be defined in terms of the national interest and must be supported with adequate power.* This is the second rule of a peace-preserving diplomacy. The national interest of a peace-loving nation can only be defined in terms of national security, and national security must be defined as integrity of the national territory and of its institutions.<sup>6</sup> National security, then, is the irreducible minimum which diplomacy must defend without compromise and even at the risk of war. With its own national interest defined in terms of national security, diplomacy must observe the third of its rules.

3. *Diplomacy must look at the political scene from the point of view of other nations.* "Nothing is so fatal to a nation as an extreme of self-partiality, and the total want of consideration of what others will naturally hope or fear."<sup>7</sup> What are other nations' national interests in terms of national security, and are they compatible with one's own? The definition of the national interest in terms of national security is easier, and the interests of the two opposing nations are more likely to be compatible, in a two-bloc system than in any other system of the balance of power. The two-bloc system, as we have seen, is more unsafe from the point of view of peace than any other, when both blocs are in competitive contact throughout the world and the ambition of both is fired by the crusading zeal of a universal mission. ". . . Vicinity, or nearness of situation, constitutes nations natural enemies."<sup>8</sup>

Yet once they have defined their national interests in terms of national security, they can draw back from their outlying positions close to, or within, the sphere of national security of the other side and retreat into their respective spheres, each self-contained within its orbit. Those outlying positions add nothing to national security; they are but liabilities, *Bataans* which cannot be held in case of war. Each bloc will be the more secure the wider it makes the distance which separates both spheres of national security. Each side can draw a line far distant from each other, making it understood that to touch or even to approach it means war. What, then, about the interjacent spaces, stretching between the two lines of demarcation? Here the fourth rule of diplomacy applies.

---

<sup>6</sup> For a more extensive discussion of the relevant problems, see above, pp. 331 ff.

<sup>7</sup> Edmund Burke, "Remarks on the Policy of the Allies with Respect to France" (1793), *Works* (Boston: Little, Brown, and Company, 1889), IV, 447.

<sup>8</sup> *The Federalist*, No. 6.



## *The Future of Diplomacy*

4. *Nations must be willing to compromise on all issues that are not vital to them.* Here diplomacy meets its most difficult task. For minds not beclouded by the crusading zeal of a political religion and capable of viewing the national interests of both sides with objectivity, the delimitation of these vital interests should not prove too difficult. Compromise on secondary issues is a different matter. Here the task is not to separate and define interests, which by their very nature already tend toward separation and definition, but to keep in balance interests which touch each other at many points and may be intertwined beyond the possibility of separation. It is an immense task to allow the other side a certain influence in those interjacent spaces without allowing them to be absorbed into the orbit of the other side. It is hardly a less immense task to keep the other side's influence as small as possible in the regions close to one's own security zone without absorbing those regions into one's own orbit. For the performance of these tasks no formula stands ready for automatic application. It is only through a continuous process of adaptation, supported both by firmness and self-restraint, that compromise on secondary issues can be made to work. It is, however, possible to indicate *a priori* what approaches will facilitate or hamper the success of policies of compromise.

First of all, it is worth noting to what extent the success of compromise, that is, compliance with the fourth rule, depends upon compliance with the other three rules which, in turn, are similarly interdependent. As the compliance with the second rule depends upon the realization of the first, so the third rule must await its realization from compliance with the second. A nation can only take a rational view of its national interests after it has parted company with the crusading spirit of a political creed. A nation is able to consider the national interests of the other side with objectivity only after it has become secure in what it considers its own national interests. Compromise on any issue, however minor, is impossible so long as both sides are not secure in their national interests. Thus nations cannot hope to comply with the fourth rule if they are not willing to comply with the other three. Both morality and expediency require compliance with these four fundamental rules.

Compliance makes compromise possible, but it does not assure its success. To give compromise, made possible through compliance with the first three rules, a chance to succeed, four other rules must be observed.

### *b) Four Prerequisites of Compromise*

1. *Give up the shadow of worthless rights for the substance of real advantage.* A diplomacy which thinks in legalistic and propagandistic terms is particularly tempted to insist upon the letter of the law, as it interprets the law, and to lose sight of the consequences which that insistence may have for its own nation and for humanity. Since there are rights to be defended, such a diplomacy thinks that the issue cannot be compromised. Yet the choice which confronts the diplomat is not between legality and illegality, but between political wisdom and political stupidity. "The question with me," said Edmund Burke, "is not whether you have a right to render your people mis-

## *Politics among Nations*

crable, but whether it is not your interest to make them happy. It is not what a lawyer tells me I *may* do, but what humanity, reason and justice tell me I ought to do.”<sup>9</sup>

2. *Never put yourself in a position from which you cannot retreat without losing face and from which you cannot advance without grave risks.* The violation of this rule is often the result of disregard for the preceding one. A diplomacy which confounds the shadow of legal right with the actuality of political advantage is likely to find itself in a position where it may have a legal right, but no political business, to be. In other words, a nation may identify itself with a position, which it may or may not have a right to hold, regardless of the political consequences. And again compromise becomes a difficult matter. A nation cannot retreat from that position without incurring a serious loss of prestige. It cannot advance from that position without exposing itself to political risks, perhaps even the risk of war. That heedless rush into untenable positions and, more particularly, the stubborn refusal to extricate oneself from them in time is the earmark of incompetent diplomacy. Its classic examples are the policy of Napoleon III on the eve of the Franco-Prussian War of 1870 and the policies of Austria and Germany on the eve of the First World War. These examples also show how closely allied is the risk of war with the violation of this rule.

3. *Never allow a weak ally to make decisions for you.* Strong nations which are oblivious to the preceding rules are particularly susceptible to violating this one. They lose their freedom of action by identifying their own national interests completely with those of the weak ally. Secure in the support of its powerful friend, the weak ally can choose the objectives and methods of its foreign policy to suit itself. The powerful nation then finds that it must support interests which are not its own and that it is unable to compromise on issues which are vital not to itself, but only to its ally.

The classic example of the violation of this rule is to be found in the way in which Turkey forced the hand of Great Britain and France on the eve of the Crimean War in 1853. The Concert of Europe had virtually agreed upon a compromise settling the conflict between Russia and Turkey, when Turkey, knowing that the Western powers would support it in a war with Russia, did its best to provoke that war and thus involved Great Britain and France in it against their will. Turkey went far in deciding the issue of war and peace for Great Britain and France according to its own national interests. Great Britain and France had to accept that decision even though their national interests did not require war with Russia and they had almost succeeded in preventing its outbreak. They had surrendered their freedom of action to a weak ally which used its control over the policies of its strong associates for its own purposes.

4. *The armed forces are the instrument of foreign policy, not its master.* No successful and no peaceful foreign policy is possible without observance of this rule. No nation can pursue a policy of compromise with the military determining the ends and means of foreign policy. The armed forces are in-

<sup>9</sup> "Speech on Conciliation with the Colonies" (1775), *The Works of Edmund Burke* (Boston: Little, Brown, and Company, 1865), II, 140.

## *The Future of Diplomacy*

struments of war; foreign policy is an instrument of peace. It is true that the ultimate objectives of the conduct of war and of the conduct of foreign policy are identical: both serve the national interest. However, both differ fundamentally in their immediate objective, in the means they employ, and in the modes of thought which they bring to bear upon their respective tasks.

The objective of war is simple and unconditional: to break the will of the enemy. Its methods are equally simple and unconditional: to bring the greatest amount of violence to bear upon the most vulnerable spot in the enemy's armor. Consequently, the military leader must think in absolute terms. He lives in the present and in the immediate future. The sole question before him is how to win victories as cheaply and quickly as possible and how to avoid defeat.

The objective of foreign policy is relative and conditional: to bend, not to break, the will of the other side as far as necessary in order to safeguard one's own vital interests without hurting those of the other side. The methods of foreign policy are relative and conditional: not to advance by destroying the obstacles in one's way, but to retreat before them, to circumvent them, to maneuver around them, to soften and dissolve them slowly by means of persuasion, negotiation, and pressure. In consequence, the mind of the diplomat is complicated and subtle. It sees the issue in hand as a moment in history, and beyond the victory of tomorrow it anticipates the incalculable possibilities of the future.

To surrender the conduct of foreign affairs to the military, then, is to destroy the possibility of compromise and thus to surrender the cause of peace. The military mind knows how to operate between the absolutes of victory and defeat. It knows nothing of that patient, intricate, and subtle maneuvering of diplomacy whose main purpose is to avoid the absolutes of victory and defeat and to meet the other side on the middle ground of negotiated compromise. A foreign policy conducted by military men according to the rules of the military art can only end in war; "for what we prepare for is what we shall get."<sup>10</sup>

For nations conscious of the potentialities of modern war, peace must be the goal of their foreign policies. Such foreign policies must be conducted in such a way as to make the preservation of peace possible and not to make the outbreak of war inevitable. In a society of sovereign nations, military force is a necessary instrument of foreign policy. Yet the instrument of foreign policy should not become the master of foreign policy. As war is fought in order to make peace possible, foreign policy should be conducted in order to make peace permanent. For the performance of both tasks, the subordination of the military under the civilian authorities, constitutionally responsible for the conduct of foreign affairs, is an indispensable prerequisite.

### 3. CONCLUSION

The way toward international peace which we have shown cannot compete in inspirational qualities with the simple and fascinating formulae

<sup>10</sup> William Graham Sumner, *loc. cit.*, p. 173.

## *Politics among Nations*

which for a century and a half have fired the imagination of a war-weary humanity. There is something spectacular in the radical simplicity of a formula which with one sweep seems to dispose of the problem of war once and for all. This has been the promise of such solutions as free trade, arbitration, disarmament, collective security, universal socialism, international government, and the world state. There is nothing spectacular, fascinating, or inspiring in the business of diplomacy.

However, we have made the point that these solutions, in so far as they deal with the real problem and not only with some of its symptoms, presuppose the existence of an integrated international society which actually does not exist. To bring into existence such an international society and keep it in being, the accommodating techniques of diplomacy are required. As the integration of domestic society and its peace develop from the unspectacular and almost unnoticed day-by-day operations of the techniques of accommodation and change, so any ultimate ideal of international life must await its realization from the techniques of persuasion, negotiation, and pressure, which are the traditional instruments of diplomacy.

The reader who has followed us to this point may well ask: But has not diplomacy failed in preventing war in the past? To that legitimate question two answers can be given.

[Diplomacy has failed many times, and it has succeeded many times, in its peace-preserving task. It has failed sometimes because nobody wanted it to succeed. We have seen how different in their objectives and methods the limited wars of the past have been from the total war of our time. When war was the normal activity of kings, the task of diplomacy was not to prevent it, but to bring it about at the most propitious moment.]

[On the other hand, when nations have used diplomacy for the purpose of preventing war, they have often succeeded. The outstanding example of a successful war-preventing diplomacy in modern times is the Congress of Berlin of 1878.] That Congress settled, or at least made susceptible to settlement, by the peaceful means of an accommodating diplomacy the issues which had separated Great Britain and Russia since the end of the Napoleonic Wars. During the better part of the nineteenth century, the conflict between Great Britain and Russia over the Balkans, the Dardanelles, and the Eastern Mediterranean hung like a suspended sword over the peace of the world. Yet, during the fifty years following the Crimean War, hostilities between Great Britain and Russia threatened to break out time and again, but never actually broke out. The main credit for the preservation of peace must go to the techniques of an accommodating diplomacy which culminated in the Congress of Berlin. When British Prime Minister Disraeli returned from that Congress to London, he declared with pride that he was bringing home "peace in our time." In fact, he had brought peace for later generations, too; for almost a century there has been no war between Great Britain and Russia.

[We have, however, recognized the precariousness of peace in a society of sovereign nations. The continuing success of diplomacy in preserving peace depends, as we have seen, upon extraordinary moral and intellectual qualities which all the leading participants must possess. A mistake in the evaluation of one of the elements of national power, made by one or the other of

## *The Future of Diplomacy*

the leading statesmen, may spell the difference between peace and war. So may an accident spoiling a plan or a power calculation.<sup>11</sup>

[Diplomacy is the best means of preserving peace which a society of sovereign nations has to offer, but, especially under the conditions of modern world politics and of modern war, it is not good enough. It is only when nations have surrendered the means of destruction which modern technology has put in their hands to a higher authority — when they have given up their sovereignty — that international peace can be made as secure as domestic peace. Diplomacy can make peace more secure than it is today, and the world state can make peace more secure than it would be if nations were to abide by the rules of diplomacy. Yet, as there can be no permanent peace without a world state, there can be no world state without the peace-preserving and community-building processes of diplomacy. For the world state to be more than a dim vision, the accommodating processes of diplomacy, mitigating and minimizing conflicts, must be revived. Whatever one's conception of the ultimate state of international affairs may be, in the recognition of that need and in the demand that it be met all men of good will can join.]

If authority were needed in support of the conception of international peace presented in these pages, it can be found in the counsel of a man who has committed fewer errors in international affairs than any of his contemporaries — Winston Churchill. Viewing with concern the contemporary scene in his speech to the House of Commons of January 23, 1948, and asking himself, "Will there be war?" Mr. Churchill called for peace through accommodation when he said:

I will only venture now to say that there seems to me to be very real danger in going on drifting too long. I believe that the best chance of preventing a war is to bring matters to a head and come to a settlement with the Soviet Government before it is too late. This would imply that the Western democracies, who should, of course, seek unity among themselves at the earliest moment, would take the initiative in asking the Soviet for a settlement.

It is idle to reason or argue with the Communists. It is, however, possible to deal with them on a fair, realistic basis, and, in my experience, they will keep their bargains as long as it is in their interest to do so, which might, in this grave matter, be a long time, once things are settled. . . .

There are very grave dangers — that is all I am going to say today — in letting everything run on and pile up until something happens, and it passes, all of a sudden, out of your control.

With all consideration of the facts, I believe it right to say today that the best chance of avoiding war is, in accord with the other Western democracies, to bring matters to a head with the Soviet Government, and, by formal diplomatic processes, with all their privacy and gravity, to arrive at a lasting settlement. There is certainly enough for the interests of all if such a settlement could be reached. Even this method, I must say, however, would not guarantee that war would not come. But I believe it would give the best chance of coming out of it alive.<sup>12</sup>

<sup>11</sup> See above, pp. III ff., 151, 152.

<sup>12</sup> *Parliamentary Debates (Hansard)*. House of Commons, Vol. 446, No. 48, pp. 562-3.

APPENDIX, BIBLIOGRAPHY,  
INDEX



## APPENDIX

# *Charter of the United Nations*

We the peoples of the United Nations  
*determined*

to save succeeding generations from the scourge of war, which twice in our lifetime has brought untold sorrow to mankind, and

to reaffirm faith in fundamental human rights, in the dignity and worth of the human person, in the equal rights of men and women and of nations large and small, and

to establish conditions under which justice and respect for the obligations arising from treaties and other sources of international law can be maintained, and

to promote social progress and better standards of life in larger freedom,

*and for these ends*

to practice tolerance and live together in peace with one another as good neighbors, and

to unite our strength to maintain international peace and security, and

to ensure, by the acceptance of principles and the institution of methods, that armed force shall not be used, save in the common interest, and

to employ international machinery for the promotion of the economic and social advancement of all peoples,

*have resolved to combine our efforts to accomplish  
these aims.*

Accordingly, our respective Governments, through representatives assembled in the city of San Francisco, who have exhibited their full powers found to be in good and due form, have agreed to the present Charter of the United Nations and do hereby establish an international organization to be known as the United Nations.



CHAPTER I

Purposes and Principles

*Article 1*

The Purposes of the United Nations are:

1. To maintain international peace and security, and to that end: to take effective collective measures for the prevention and removal of threats to the peace, and for the suppression of acts of aggression or other breaches of the peace, and to bring about by peaceful means, and in conformity with the principles of justice and international law, adjustment or settlement of international disputes or situations which might lead to a breach of the peace;
2. To develop friendly relations among nations based on respect for the principle of equal rights and self-determination of peoples, and to take other appropriate measures to strengthen universal peace;
3. To achieve international cooperation in solving international problems of an economic, social, cultural, or humanitarian character, and in promoting and encouraging respect for human rights and for fundamental freedoms for all without distinction as to race, sex, language, or religion; and
4. To be a center for harmonizing the actions of nations in the attainment of these common ends.

*Article 2*

The Organization and its Members, in pursuit of the Purposes stated in Article 1, shall act in accordance with the following Principles.

1. The Organization is based on the principle of the sovereign equality of all its Members.
2. All Members, in order to ensure to all of them the rights and benefits resulting from membership, shall fulfil in good faith the obligations assumed by them in accordance with the present Charter.
3. All Members shall settle their international disputes by peaceful means in such a manner that international peace and security, and justice, are not endangered.
4. All Members shall refrain in their international relations from the threat or use of force against the territorial integrity or political independence of any state, or in any other manner inconsistent with the Purposes of the United Nations.
5. All Members shall give the United Nations every assistance in any action it takes in accordance with the present Charter, and shall refrain from giving assistance to any state against which the United Nations is taking preventive or enforcement action.
6. The Organization shall ensure that states which are not Members of the United Nations act in accordance with these Principles so far as may be necessary for the maintenance of international peace and security.
7. Nothing contained in the present Charter shall authorize the United Nations to intervene in matters which are essentially within the domestic jurisdiction of any state or shall require the Members to submit such matters to settlement under the present Charter; but this principle shall not prejudice the application of enforcement measures under Chapter VII.

CHAPTER II  
Membership

*Article 3*

The original Members of the United Nations shall be the states which, having participated in the United Nations Conference on International Organization at San Francisco, or having previously signed the Declaration by United Nations of January 1, 1942, sign the present Charter and ratify it in accordance with Article 110.

*Article 4*

1. Membership in the United Nations is open to all other peace-loving states which accept the obligations contained in the present Charter and, in the judgment of the Organization, are able and willing to carry out these obligations.

2. The admission of any such state to membership in the United Nations will be effected by a decision of the General Assembly upon the recommendation of the Security Council.

*Article 5*

A Member of the United Nations against which preventive or enforcement action has been taken by the Security Council may be suspended from the exercise of the rights and privileges of membership by the General Assembly upon the recommendation of the Security Council. The exercise of these rights and privileges may be restored by the Security Council.

*Article 6*

A Member of the United Nations which has persistently violated the Principles contained in the present Charter may be expelled from the Organization by the General Assembly upon the recommendation of the Security Council.

CHAPTER III

Organs

*Article 7*

1. There are established as the principal organs of the United Nations: a General Assembly, a Security Council, an Economic and Social Council, a Trusteeship Council, an International Court of Justice, and a Secretariat.

2. Such subsidiary organs as may be found necessary may be established in accordance with the present Charter.

*Article 8*

The United Nations shall place no restrictions on the eligibility of men and women to participate in any capacity and under conditions of equality in its principal and subsidiary organs.

CHAPTER IV

The General Assembly

COMPOSITION

*Article 9*

1. The General Assembly shall consist of all the Members of the United Nations.
2. Each Member shall have not more than five representatives in the General Assembly.

FUNCTIONS AND POWERS

*Article 10*

The General Assembly may discuss any questions or any matters within the scope of the present Charter or relating to the powers and functions of any organs provided for in the present Charter, and except as provided in Article 12, may make recommendations to the Members of the United Nations or to the Security Council or to both on any such questions or matters.

*Article 11*

1. The General Assembly may consider the general principles of cooperation in the maintenance of international peace and security, including the principles governing disarmament and the regulation of armaments, and may make recommendations with regard to such principles to the Members or to the Security Council or to both.
2. The General Assembly may discuss any questions relating to the maintenance of international peace and security brought before it by any Member of the United Nations, or by the Security Council, or by a state which is not a Member of the United Nations in accordance with Article 35, paragraph 2, and, except as provided in Article 12, may make recommendations with regard to any such questions to the state or states concerned or to the Security Council or to both. Any such question on which action is necessary shall be referred to the Security Council by the General Assembly either before or after discussion.
3. The General Assembly may call the attention of the Security Council to situations which are likely to endanger international peace and security.
4. The powers of the General Assembly set forth in this Article shall not limit the general scope of Article 10.

*Article 12*

1. While the Security Council is exercising in respect of any dispute or situation the functions assigned to it in the present Charter, the General Assembly shall not make any recommendation with regard to that dispute or situation unless the Security Council so requests.
2. The Secretary-General, with the consent of the Security Council, shall notify the General Assembly at each session of any matters relative to the maintenance of international peace and security which are being dealt with by the Security Council and shall similarly notify the General Assembly, or the Members of the United Nations if the General Assembly is not in session, immediately the Security Council ceases to deal with such matters.

*Article 13*

1. The General Assembly shall initiate studies and make recommendations for the purpose of:
  - a. promoting international cooperation in the political field and encouraging the progressive development of international law and its codification;
  - b. promoting international cooperation in the economic, social, cultural, educational, and health fields, and assisting in the realization of human rights and fundamental freedoms for all without distinction as to race, sex, language, or religion.
2. The further responsibilities, functions, and powers of the General Assembly with respect to matters mentioned in paragraph 1 (b) above are set forth in Chapters IX and X.

*Article 14*

Subject to the provisions of Article 12, the General Assembly may recommend measures for the peaceful adjustment of any situation, regardless of origin, which it deems likely to impair the general welfare or friendly relations among nations, including situations resulting from a violation of the provisions of the present Charter setting forth the Purposes and Principles of the United Nations.

*Article 15*

1. The General Assembly shall receive and consider annual and special reports from the Security Council; these reports shall include an account of the measures that the Security Council has decided upon or taken to maintain international peace and security.
2. The General Assembly shall receive and consider reports from the other organs of the United Nations.

*Article 16*

The General Assembly shall perform such functions with respect to the international trusteeship system as are assigned to it under Chapters XII and XIII, including the approval of the trusteeship agreements for areas not designated as strategic.

*Article 17*

1. The General Assembly shall consider and approve the budget of the Organization.
2. The expenses of the Organization shall be borne by the Members as apportioned by the General Assembly.
3. The General Assembly shall consider and approve any financial and budgetary arrangements with specialized agencies referred to in Article 57 and shall examine the administrative budgets of such specialized agencies with a view to making recommendations to the agencies concerned.

*VOTING*

*Article 18*

1. Each member of the General Assembly shall have one vote.
2. Decisions of the General Assembly on important questions shall be made by a two-thirds majority of the members present and voting. These questions shall

## *Politics among Nations*

include: recommendations with respect to the maintenance of international peace and security, the election of the non-permanent members of the Security Council, the election of the members of the Economic and Social Council, the election of members of the Trusteeship Council in accordance with paragraph 1 (c) of Article 86, the admission of new Members to the United Nations, the suspension of the rights and privileges of membership, the expulsion of Members, questions relating to the operation of the trusteeship system, and budgetary questions.

3. Decisions on other questions, including the determination of additional categories of questions to be decided by a two-thirds majority, shall be made by a majority of the members present and voting.

### *Article 19*

A Member of the United Nations which is in arrears in the payment of its financial contributions to the Organization shall have no vote in the General Assembly if the amount of its arrears equals or exceeds the amount of the contributions due from it for the preceding two full years. The General Assembly may, nevertheless, permit such a Member to vote if it is satisfied that the failure to pay is due to conditions beyond the control of the Member.

## *PROCEDURE*

### *Article 20*

The General Assembly shall meet in regular annual sessions and in such special sessions as occasion may require. Special sessions shall be convoked by the Secretary-General at the request of the Security Council or of a majority of the Members of the United Nations.

### *Article 21*

The General Assembly shall adopt its own rules of procedure. It shall elect its President for each session.

### *Article 22*

The General Assembly may establish such subsidiary organs as it deems necessary for the performance of its functions.

## CHAPTER V

# The Security Council

## *COMPOSITION*

### *Article 23*

1. The Security Council shall consist of eleven Members of the United Nations. The Republic of China, France, the Union of Soviet Socialist Republics, the United Kingdom of Great Britain and Northern Ireland, and the United States of America shall be permanent members of the Security Council. The General Assembly shall elect six other Members of the United Nations to be non-permanent members of the Security Council, due regard being specially paid, in the first instance to the contribution of Members of the United Nations to the maintenance

## *Appendix*

of international peace and security and to the other purposes of the Organization, and also to equitable geographical distribution.

2. The non-permanent members of the Security Council shall be elected for a term of two years. In the first election of the non-permanent members, however, three shall be chosen for a term of one year. A retiring member shall not be eligible for immediate re-election.

3. Each member of the Security Council shall have one representative.

### *FUNCTIONS AND POWERS*

#### *Article 24*

1. In order to ensure prompt and effective action by the United Nations, its Members confer on the Security Council primary responsibility for the maintenance of international peace and security, and agree that in carrying out its duties under this responsibility the Security Council acts on their behalf.

2. In discharging these duties the Security Council shall act in accordance with the Purposes and Principles of the United Nations. The specific powers granted to the Security Council for the discharge of these duties are laid down in Chapters VI, VII, VIII, and XII.

3. The Security Council shall submit annual and, when necessary, special reports to the General Assembly for its consideration.

#### *Article 25*

The Members of the United Nations agree to accept and carry out the decisions of the Security Council in accordance with the present Charter.

#### *Article 26*

In order to promote the establishment and maintenance of international peace and security with the least diversion for armaments of the world's human and economic resources, the Security Council shall be responsible for formulating, with the assistance of the Military Staff Committee referred to in Article 47, plans to be submitted to the Members of the United Nations for the establishment of a system for the regulations of armaments.

### *VOTING*

#### *Article 27*

1. Each member of the Security Council shall have one vote.

2. Decisions of the Security Council on procedural matters shall be made by an affirmative vote of seven members.

3. Decisions of the Security Council on all other matters shall be made by an affirmative vote of seven members including the concurring votes of the permanent members; provided that, in decisions under Chapter VI, and under paragraph 3 of Article 52, a party to a dispute shall abstain from voting.

### *PROCEDURE*

#### *Article 28*

1. The Security Council shall be so organized as to be able to function continuously. Each member of the Security Council shall for this purpose be represented at all times at the seat of the Organization.

## *Politics among Nations*

2. The Security Council shall hold periodic meetings at which each of its members may, if it so desires, be represented by a member of the government or by some other specially designated representative.

3. The Security Council may hold meetings at such places other than the seat of the Organization as in its judgment will best facilitate its work.

### *Article 29*

The Security Council may establish such subsidiary organs as it deems necessary for the performance of its functions.

### *Article 30*

The Security Council shall adopt its own rules of procedure, including the method of selecting its President.

### *Article 31*

Any Member of the United Nations which is not a member of the Security Council may participate, without vote, in the discussion of any question brought before the Security Council whenever the latter considers that the interests of that Member are specially affected.

### *Article 32*

Any Member of the United Nations which is not a member of the Security Council or any state which is not a Member of the United Nations, if it is a party to a dispute under consideration by the Security Council, shall be invited to participate, without vote, in the discussion relating to the dispute. The Security Council shall lay down such conditions as it deems just for the participation of a state which is not a Member of the United Nations.

## CHAPTER VI

## Pacific Settlement of Disputes

### *Article 33*

1. The parties to any dispute, the continuance of which is likely to endanger the maintenance of international peace and security, shall, first of all, seek a solution by negotiation, enquiry, mediation, conciliation, arbitration, judicial settlement, resort to regional agencies or arrangements, or other peaceful means of their own choice.

2. The Security Council shall, when it deems necessary, call upon the parties to settle their dispute by such means.

### *Article 34*

The Security Council may investigate any dispute, or any situation which might lead to international friction or give rise to a dispute, in order to determine whether the continuance of the dispute or situation is likely to endanger the maintenance of international peace and security.

*Article 35*

1. Any Member of the United Nations may bring any dispute, or any situation of the nature referred to in Article 34, to the attention of the Security Council or of the General Assembly.

2. A state which is not a Member of the United Nations may bring to the attention of the Security Council or of the General Assembly any dispute to which it is a party if it accepts in advance, for the purposes of the dispute, the obligations of pacific settlement provided in the present Charter.

3. The proceedings of the General Assembly in respect of matters brought to its attention under this Article will be subject to the provisions of Articles 11 and 12.

*Article 36*

1. The Security Council may, at any stage of a dispute of the nature referred to in Article 33 or of a situation of like nature, recommend appropriate procedures or methods of adjustment.

2. The Security Council should take into consideration any procedures for the settlement of the dispute which have already been adopted by the parties.

3. In making recommendations under this Article the Security Council should also take into consideration that legal disputes should as a general rule be referred by the parties to the International Court of Justice in accordance with the provisions of the Statute of the Court.

*Article 37*

1. Should the parties to a dispute of the nature referred to in Article 33 fail to settle it by the means indicated in that Article, they shall refer it to the Security Council.

2. If the Security Council deems that the continuance of the dispute is in fact likely to endanger the maintenance of international peace and security, it shall decide whether to take action under Article 36 or to recommend such terms of settlement as it may consider appropriate.

*Article 38*

Without prejudice to the provisions of Articles 33 to 37, the Security Council may, if all the parties to any dispute so request, make recommendations to the parties with a view to a pacific settlement of the dispute.

CHAPTER VII

Action With Respect to Threats to the Peace,  
Breaches of the Peace,  
and Acts of Aggression

*Article 39*

The Security Council shall determine the existence of any threat to the peace, breach of the peace, or act of aggression and shall make recommendations, or decide what measures shall be taken in accordance with Articles 41 and 42, to maintain or restore international peace and security.



## *Politics among Nations*

### *Article 40*

In order to prevent an aggravation of the situation, the Security Council may, before making the recommendations or deciding upon the measures provided for in Article 39, call upon the parties concerned to comply with such provisional measures as it deems necessary or desirable. Such provisional measures shall be without prejudice to the rights, claims, or position of the parties concerned. The Security Council shall duly take account of failure to comply with such provisional measures.

### *Article 41*

The Security Council may decide what measures not involving the use of armed force are to be employed to give effect to its decisions, and it may call upon the Members of the United Nations to apply such measures. These may include complete or partial interruption of economic relations and of rail, sea, air, postal, telegraphic, radio, and other means of communication, and the severance of diplomatic relations.

### *Article 42*

Should the Security Council consider that measures provided for in Article 41 would be inadequate or have proved to be inadequate, it may take such action by air, sea, or land forces as may be necessary to maintain or restore international peace and security. Such action may include demonstrations, blockade, and other operations by air, sea, or land forces of Members of the United Nations.

### *Article 43*

1. All Members of the United Nations, in order to contribute to the maintenance of international peace and security, undertake to make available to the Security Council, on its call and in accordance with a special agreement or agreements, armed forces, assistance, and facilities, including rights of passage, necessary for the purpose of maintaining international peace and security.

2. Such agreement or agreements shall govern the numbers and types of forces, their degree of readiness and general location, and the nature of the facilities and assistance to be provided.

3. The agreement or agreements shall be negotiated as soon as possible on the initiative of the Security Council. They shall be concluded between the Security Council and Members or between the Security Council and groups of Members and shall be subject to ratification by the signatory states in accordance with their respective constitutional processes.

### *Article 44*

When the Security Council has decided to use force it shall, before calling upon a Member not represented on it to provide armed forces in fulfillment of the obligations assumed under Article 43, invite that Member, if the Member so desires, to participate in the decisions of the Security Council concerning the employment of contingents of that Member's armed forces.

### *Article 45*

In order to enable the United Nations to take urgent military measures, Members shall hold immediately available national air-force contingents for combined international enforcement action. The strength and degree of readiness of these

## *Appendix*

contingents and plans for their combined action shall be determined, within the limits laid down in the special agreement or agreements referred to in Article 43, by the Security Council with the assistance of the Military Staff Committee.

### *Article 46*

Plans for the application of armed force shall be made by the Security Council with the assistance of the Military Staff Committee.

### *Article 47*

1. There shall be established a Military Staff Committee to advise and assist the Security Council on all questions relating to the Security Council's military requirements for the maintenance of international peace and security, the employment and command of forces placed at its disposal, the regulation of armaments, and possible disarmament.

2. The Military Staff Committee shall consist of the Chiefs of Staff of the permanent members of the Security Council or their representatives. Any Member of the United Nations not permanently represented on the Committee shall be invited by the Committee to be associated with it when the efficient discharge of the Committee's responsibilities requires the participation of that Member in its work.

3. The Military Staff Committee shall be responsible under the Security Council for the strategic direction of any armed forces placed at the disposal of the Security Council. Questions relating to the command of such forces shall be worked out subsequently.

4. The Military Staff Committee, with the authorization of the Security Council and after consultation with appropriate regional agencies, may establish regional subcommittees.

### *Article 48*

1. The action required to carry out the decisions of the Security Council for the maintenance of international peace and security shall be taken by all the Members of the United Nations or by some of them, as the Security Council may determine.

2. Such decisions shall be carried out by the Members of the United Nations directly and through their action in the appropriate international agencies of which they are members.

### *Article 49*

The Members of the United Nations shall join in affording mutual assistance in carrying out the measures decided upon by the Security Council.

### *Article 50*

If preventive or enforcement measures against any state are taken by the Security Council, any other state, whether a Member of the United Nations or not, which finds itself confronted with special economic problems arising from the carrying out of those measures shall have the right to consult the Security Council with regard to a solution of those problems.

### *Article 51*

Nothing in the present Charter shall impair the inherent right of individual or collective self-defense if an armed attack occurs against a Member of the United

## *Politics among Nations*

Nations, until the Security Council has taken the measures necessary to maintain international peace and security. Measures taken by Members in the exercise of this right of self-defense shall be immediately reported to the Security Council and shall not in any way affect the authority and responsibility of the Security Council under the present Charter to take at any time such action as it deems necessary in order to maintain or restore international peace and security.

### CHAPTER VIII

## Regional Arrangements

### *Article 52*

1. Nothing in the present Charter precludes the existence of regional arrangements or agencies for dealing with such matters relating to the maintenance of international peace and security as are appropriate for regional action, provided that such arrangements or agencies and their activities are consistent with the Purposes and Principles of the United Nations.

2. The Members of the United Nations entering into such arrangements or constituting such agencies shall make every effort to achieve pacific settlement of local disputes through such regional arrangements or by such regional agencies before referring them to the Security Council.

3. The Security Council shall encourage the development of pacific settlement of local disputes through such regional arrangements or by such regional agencies either on the initiative of the states concerned or by reference from the Security Council.

4. This Article in no way impairs the application of Articles 34 and 35.

### *Article 53*

1. The Security Council shall, where appropriate, utilize such regional arrangements or agencies for enforcement action under its authority. But no enforcement action shall be taken under regional arrangements or by regional agencies without the authorization of the Security Council, with the exception of measures against any enemy state, as defined in paragraph 2 of this Article, provided for pursuant to Article 107 or in regional arrangements directed against renewal of aggressive policy on the part of any such state, until such time as the Organization may, on request of the Governments concerned, be charged with the responsibility for preventing further aggression by such a state.

2. The term enemy state as used in paragraph 1 of this Article applies to any state which during the Second World War has been an enemy of any signatory of the present Charter.

### *Article 54*

The Security Council shall at all times be kept fully informed of activities undertaken or in contemplation under regional arrangements or by regional agencies for the maintenance of international peace and security.

CHAPTER IX

International Economic and Social Cooperation

*Article 55*

With a view to the creation of conditions of stability and well-being which are necessary for peaceful and friendly relations among nations based on respect for the principle of equal rights and self-determination of peoples, the United Nations shall promote:

- a. higher standards of living, full employment, and conditions of economic and social progress and development;
- b. solutions of international economic, social, health, and related problems; and international cultural and educational cooperation; and
- c. universal respect for, and observance of, human rights and fundamental freedoms for all without distinction as to race, sex, language, or religion.

*Article 56*

All Members pledge themselves to take joint and separate action in cooperation with the Organization for the achievement of the purposes set forth in Article 55.

*Article 57*

1. The various specialized agencies, established by intergovernmental agreement and having wide international responsibilities, as defined in their basic instruments, in economic, social, cultural, educational, health, and related fields, shall be brought into relationship with the United Nations in accordance with the provisions of Article 63.

2. Such agencies thus brought into relationship with the United Nations are hereinafter referred to as specialized agencies.

*Article 58*

The Organization shall make recommendations for the coordination of the policies and activities of the specialized agencies.

*Article 59*

The Organization shall, where appropriate, initiate negotiations among the states concerned for the creation of any new specialized agencies required for the accomplishment of the purposes set forth in Article 55.

*Article 60*

Responsibility for the discharge of the functions of the Organization set forth in this Chapter shall be vested in the General Assembly and, under the authority of the General Assembly, in the Economic and Social Council, which shall have for this purpose the powers set forth in Chapter X.

CHAPTER X

The Economic and Social Council

COMPOSITION

*Article 61*

1. The Economic and Social Council shall consist of eighteen Members of the United Nations elected by the General Assembly.

2. Subject to the provisions of paragraph 3, six members of the Economic and Social Council shall be elected each year for a term of three years. A retiring member shall be eligible for immediate re-election.

3. At the first election, eighteen members of the Economic and Social Council shall be chosen. The term of office of six members so chosen shall expire at the end of one year, and of six other members at the end of two years, in accordance with arrangements made by the General Assembly.

4. Each member of the Economic and Social Council shall have one representative.

FUNCTIONS AND POWERS

*Article 62*

1. The Economic and Social Council may make or initiate studies and reports with respect to international economic, social, cultural, educational, health, and related matters and may make recommendations with respect to any such matters to the General Assembly, to the Members of the United Nations, and to the specialized agencies concerned.

2. It may make recommendations for the purpose of promoting respect for, and observance of, human rights and fundamental freedoms for all.

3. It may prepare draft conventions for submission to the General Assembly, with respect to matters falling within its competence.

4. It may call, in accordance with the rules prescribed by the United Nations, international conferences on matters falling within its competence.

*Article 63*

1. The Economic and Social Council may enter into agreements with any of the agencies referred to in Article 57, defining the terms on which the agency concerned shall be brought into relationship with the United Nations. Such agreements shall be subject to approval by the General Assembly.

2. It may coordinate the activities of the specialized agencies through consultation with and recommendations to such agencies and through recommendations to the General Assembly and to the Members of the United Nations.

*Article 64*

1. The Economic and Social Council may take appropriate steps to obtain regular reports from the specialized agencies. It may make arrangements with the Members of the United Nations and with the specialized agencies to obtain reports on the steps taken to give effect to its own recommendations and to recommendations on matters falling within its competence made by the General Assembly.

## *Appendix*

2. It may communicate its observations on these reports to the General Assembly.

### *Article 65*

The Economic and Social Council may furnish information to the Security Council and shall assist the Security Council upon its request.

### *Article 66*

1. The Economic and Social Council shall perform such functions as fall within its competence in connection with the carrying out of the recommendations of the General Assembly.

2. It may, with the approval of the General Assembly, perform services at the request of Members of the United Nations and at the request of specialized agencies.

3. It shall perform such other functions as are specified elsewhere in the present Charter or as may be assigned to it by the General Assembly.

## *VOTING*

### *Article 67*

1. Each member of the Economic and Social Council shall have one vote.

2. Decisions of the Economic and Social Council shall be made by a majority of the members present and voting.

## *PROCEDURE*

### *Article 68*

The Economic and Social Council shall set up commissions in economic and social fields and for the promotion of human rights, and such other commissions as may be required for the performance of its functions.

### *Article 69*

The Economic and Social Council shall invite any Member of the United Nations to participate, without vote, in its deliberations on any matter of particular concern to that Member.

### *Article 70*

The Economic and Social Council may make arrangements for representatives of the specialized agencies to participate, without vote, in its deliberations and in those of the commissions established by it, and for its representatives to participate in the deliberations of the specialized agencies.

### *Article 71*

The Economic and Social Council may make suitable arrangements for consultation with non-governmental organizations which are concerned with matters within its competence. Such arrangements may be made with international organizations and, where appropriate, with national organizations after consultation with the Member of the United Nations concerned.

## *Politics among Nations*

### *Article 72*

1. The Economic and Social Council shall adopt its own rules of procedure, including the method of selecting its President.
2. The Economic and Social Council shall meet as required in accordance with its rules, which shall include provision for the convening of meetings on the request of a majority of its members.

### CHAPTER XI

## Declaration Regarding Non-Self-Governing Territories

### *Article 73*

Members of the United Nations which have or assume responsibilities for the administration of territories whose peoples have not yet attained a full measure of self-government recognize the principle that the interests of the inhabitants of these territories are paramount, and accept as a sacred trust the obligation to promote to the utmost, within the system of international peace and security established by the present Charter, the well-being of the inhabitants of these territories, and, to this end:

- a. to ensure, with due respect for the culture of the peoples concerned, their political, economic, social, and educational advancement, their just treatment, and their protection against abuses;
- b. to develop self-government, to take due account of the political aspirations of the peoples, and to assist them in the progressive development of their free political institutions, according to the particular circumstances of each territory and its peoples and their varying stages of advancement;
- c. to further international peace and security;
- d. to promote constructive measures of development, to encourage research, and to cooperate with one another and, when and where appropriate, with specialized international bodies with a view to the practical achievement of the social, economic, and scientific purposes set forth in this Article; and
- e. to transmit regularly to the Secretary-General for information purposes, subject to such limitation as security and constitutional considerations may require, statistical and other information of a technical nature relating to economic, social, and educational conditions in the territories for which they are respectively responsible other than those territories to which Chapters XII and XIII apply.

### *Article 74*

Members of the United Nations also agree that their policy in respect of the territories to which this Chapter applies, no less than in respect of their metropolitan areas, must be based on the general principle of good-neighborliness, due account being taken of the interests and well-being of the rest of the world, in social, economic, and commercial matters.

CHAPTER XII

International Trusteeship System

*Article 75*

The United Nations shall establish under its authority an international trusteeship system for the administration and supervision of such territories as may be placed thereunder by subsequent individual agreements. These territories are hereinafter referred to as trust territories.

*Article 76*

The basic objectives of the trusteeship system, in accordance with the Purposes of the United Nations laid down in Article 1 of the present Charter, shall be:

- a. to further international peace and security;
- b. to promote the political, economic, social, and educational advancement of the inhabitants of the trust territories, and their progressive development towards self-government or independence as may be appropriate to the particular circumstances of each territory and its peoples and the freely expressed wishes of the peoples concerned, and as may be provided by the terms of each trusteeship agreement;
- c. to encourage respect for human rights and for fundamental freedoms for all without distinction as to race, sex, language, or religion, and to encourage recognition of the interdependence of the peoples of the world; and
- d. to ensure equal treatment in social, economic, and commercial matters for all Members of the United Nations and their nationals, and also equal treatment for the latter in the administration of justice, without prejudice to the attainment of the foregoing objectives and subject to the provisions of Article 80.

*Article 77*

1. The trusteeship system shall apply to such territories in the following categories as may be placed thereunder by means of trusteeship agreements:
  - a. territories now held under mandate;
  - b. territories which may be detached from enemy states as a result of the Second World War; and
  - c. territories voluntarily placed under the system by states responsible for their administration.
2. It will be a matter for subsequent agreement as to which territories in the foregoing categories will be brought under the trusteeship system and upon what terms.

*Article 78*

The trusteeship system shall not apply to territories which have become Members of the United Nations, relationship among which shall be based on respect for the principle of sovereign equality.

*Article 79*

The terms of trusteeship for each territory to be placed under the trusteeship system, including any alteration or amendment, shall be agreed upon by the states directly concerned, including the mandatory power in the case of territories held



## *Politics among Nations*

under mandate by a Member of the United Nations, and shall be approved as provided for in Articles 83 and 85.

### *Article 80*

1. Except as may be agreed upon in individual trusteeship agreements, made under Articles 77, 79, and 81, placing each territory under the trusteeship system, and until such agreements have been concluded, nothing in this Chapter shall be construed in or of itself to alter in any manner the rights whatsoever of any states or any peoples or the terms of existing international instruments to which Members of the United Nations may respectively be parties.

2. Paragraph 1 of this Article shall not be interpreted as giving grounds for delay or postponement of the negotiation and conclusion of agreements for placing mandated and other territories under the trusteeship system as provided for in Article 77.

### *Article 81*

The trusteeship agreement shall in each case include the terms under which the trust territory will be administered and designate the authority which will exercise the administration of the trust territory. Such authority, hereinafter called the administering authority, may be one or more states or the Organization itself.

### *Article 82*

There may be designated, in any trusteeship agreement, a strategic area or areas which may include part or all of the trust territory to which the agreement applies, without prejudice to any special agreement or agreements made under Article 43.

### *Article 83*

1. All functions of the United Nations relating to strategic areas, including the approval of the terms of the trusteeship agreements and of their alteration or amendment, shall be exercised by the Security Council.

2. The basic objectives set forth in Article 76 shall be applicable to the people of each strategic area.

3. The Security Council shall, subject to the provisions of the trusteeship agreements and without prejudice to security considerations, avail itself of the assistance of the Trusteeship Council to perform those functions of the United Nations under the trusteeship system relating to political, economic, social, and educational matters in the strategic areas.

### *Article 84*

It shall be the duty of the administering authority to ensure that the trust territory shall play its part in the maintenance of international peace and security. To this end the administering authority may make use of volunteer forces, facilities, and assistance from the trust territory in carrying out the obligations towards the Security Council undertaken in this regard by the administering authority, as well as for local defense and the maintenance of law and order within the trust territory.

### *Article 85*

1. The functions of the United Nations with regard to trusteeship agreements for all areas not designated as strategic, including the approval of the terms of

the trusteeship agreements and of their alteration or amendment, shall be exercised by the General Assembly.

2. The Trusteeship Council, operating under the authority of the General Assembly, shall assist the General Assembly in carrying out these functions.

CHAPTER XIII

The Trusteeship Council

COMPOSITION

*Article 86*

1. The Trusteeship Council shall consist of the following Members of the United Nations:

- a. those Members administering trust territories;
- b. such of those Members mentioned by name in Article 23 as are not administering trust territories; and
- c. as many other Members elected for three-year terms by the General Assembly as may be necessary to ensure that the total number of members of the Trusteeship Council is equally divided between those Members of the United Nations which administer trust territories and those which do not.

2. Each member of the Trusteeship Council shall designate one specially qualified person to represent it therein.

FUNCTIONS AND POWERS

*Article 87*

The General Assembly and, under its authority, the Trusteeship Council, in carrying out their functions, may:

- a. consider reports submitted by the administering authority;
- b. accept petitions and examine them in consultation with the administering authority;
- c. provide for periodic visits to the respective trust territories at times agreed upon with the administering authority; and
- d. take these and other actions in conformity with the terms of the trusteeship agreements.

*Article 88*

The Trusteeship Council shall formulate a questionnaire on the political, economic, social, and educational advancement of the inhabitants of each trust territory, and the administering authority for each trust territory within the competence of the General Assembly shall make an annual report to the General Assembly upon the basis of such questionnaire.

VOTING

*Article 89*

1. Each member of the Trusteeship Council shall have one vote.
2. Decisions of the Trusteeship Council shall be made by a majority of the members present and voting.

PROCEDURE

*Article 90*

1. The Trusteeship Council shall adopt its own rules of procedure, including the method of selecting its President.
2. The Trusteeship Council shall meet as required in accordance with its rules, which shall include provision for the convening of meetings on the request of a majority of its members.

*Article 91*

The Trusteeship Council shall, when appropriate, avail itself of the assistance of the Economic and Social Council and of the specialized agencies in regard to matters with which they are respectively concerned.

CHAPTER XIV

The International Court of Justice

*Article 92*

The International Court of Justice shall be the principal judicial organ of the United Nations. It shall function in accordance with the annexed Statute, which is based upon the Statute of the Permanent Court of International Justice and forms an integral part of the present Charter.

*Article 93*

1. All Members of the United Nations are *ipso facto* parties to the Statute of the International Court of Justice.
2. A state which is not a Member of the United Nations may become a party to the Statute of the International Court of Justice on conditions to be determined in each case by the General Assembly upon the recommendation of the Security Council.

*Article 94*

1. Each Member of the United Nations undertakes to comply with the decision of the International Court of Justice in any case to which it is a party.
2. If any party to a case fails to perform the obligations incumbent upon it under a judgment rendered by the Court, the other party may have recourse to the Security Council, which may, if it deems necessary, make recommendations or decide upon measures to be taken to give effect to the judgment.

*Article 95*

Nothing in the present Charter shall prevent Members of the United Nations from entrusting the solution of their differences to other tribunals by virtue of agreements already in existence or which may be concluded in the future.

*Article 96*

1. The General Assembly or the Security Council may request the International Court of Justice to give an advisory opinion on any legal question.
2. Other organs of the United Nations and specialized agencies, which may at

any time be so authorized by the General Assembly, may also request advisory opinions of the Court on legal questions arising within the scope of their activities.

CHAPTER XV

**The Secretariat**

*Article 97*

The Secretariat shall comprise a Secretary-General and such staff as the Organization may require. The Secretary-General shall be appointed by the General Assembly upon the recommendation of the Security Council. He shall be the chief administrative officer of the Organization.

*Article 98*

The Secretary-General shall act in that capacity in all meetings of the General Assembly, of the Security Council, of the Economic and Social Council, and of the Trusteeship Council, and shall perform such other functions as are entrusted to him by these organs. The Secretary-General shall make an annual report to the General Assembly on the work of the Organization.

*Article 99*

The Secretary-General may bring to the attention of the Security Council any matter which in his opinion may threaten the maintenance of international peace and security.

*Article 100*

1. In the performance of their duties the Secretary-General and the staff shall not seek or receive instructions from any government or from any other authority external to the Organization. They shall refrain from any action which might reflect on their position as international officials responsible only to the Organization.

2. Each Member of the United Nations undertakes to respect the exclusively international character of the responsibilities of the Secretary-General and the staff and not to seek to influence them in the discharge of their responsibilities.

*Article 101*

1. The staff shall be appointed by the Secretary-General under regulations established by the General Assembly.

2. Appropriate staffs shall be permanently assigned to the Economic and Social Council, the Trusteeship Council, and, as required, to other organs of the United Nations. These staffs shall form a part of the Secretariat.

3. The paramount consideration in the employment of the staff and in the determination of the conditions of service shall be the necessity of securing the highest standards of efficiency, competence, and integrity. Due regard shall be paid to the importance of recruiting the staff on as wide a geographical basis as possible.

## *Politics among Nations*

### CHAPTER XVI

## Miscellaneous Provisions

### *Article 102*

1. Every treaty and every international agreement entered into by any Member of the United Nations after the present Charter comes into force shall as soon as possible be registered with the Secretariat and published by it.

2. No party to any such treaty or international agreement which has not been registered in accordance with the provisions of paragraph 1 of this Article may invoke that treaty or agreement before any organ of the United Nations.

### *Article 103*

In the event of a conflict between the obligations of the Members of the United Nations under the present Charter and their obligations under any other international agreement, their obligations under the present Charter shall prevail.

### *Article 104*

The Organization shall enjoy in the territory of each of its Members such legal capacity as may be necessary for the exercise of its functions and the fulfillment of its purposes.

### *Article 105*

1. The Organization shall enjoy in the territory of each of its Members such privileges and immunities as are necessary for the fulfillment of its purposes.

2. Representatives of the Members of the United Nations and officials of the Organization shall similarly enjoy such privileges and immunities as are necessary for the independent exercise of their functions in connection with the Organization.

3. The General Assembly may make recommendations with a view to determining the details of the application of paragraphs 1 and 2 of this Article or may propose conventions to the Members of the United Nations for this purpose.

### CHAPTER XVII

## Transitional Security Arrangements

### *Article 106*

Pending the coming into force of such special agreements referred to in Article 43 as in the opinion of the Security Council enable it to begin the exercise of its responsibilities under Article 42, the parties to the Four-Nation Declaration, signed at Moscow, October 30, 1943, and France, shall, in accordance with the provisions of paragraph 5 of that Declaration, consult with one another and as occasion requires with other Members of the United Nations with a view to such joint action on behalf of the Organization as may be necessary for the purpose of maintaining international peace and security.

### *Article 107*

Nothing in the present Charter shall invalidate or preclude action, in relation to any state which during the Second World War has been an enemy of any sig-

natory to the present Charter, taken or authorized as a result of that war by the Governments having responsibility for such action.

CHAPTER XVIII

Amendments

*Article 108*

Amendments to the present Charter shall come into force for all Members of the United Nations when they have been adopted by a vote of two thirds of the members of the General Assembly and ratified in accordance with their respective constitutional processes by two thirds of the Members of the United Nations, including all the permanent members of the Security Council.

*Article 109*

1. A General Conference of the Members of the United Nations for the purpose of reviewing the present Charter may be held at a date and place to be fixed by a two-thirds vote of the members of the General Assembly and by a vote of any seven members of the Security Council. Each Member of the United Nations shall have one vote in the conference.

2. Any alteration of the present Charter recommended by a two-thirds vote of the conference shall take effect when ratified in accordance with their respective constitutional processes by two thirds of the Members of the United Nations including all the permanent members of the Security Council.

3. If such a conference has not been held before the tenth annual session of the General Assembly following the coming into force of the present Charter, the proposal to call such a conference shall be placed on the agenda of that session of the General Assembly, and the conference shall be held if so decided by a majority vote of the members of the General Assembly and by a vote of any seven members of the Security Council.

CHAPTER XIX

Ratification and Signature

*Article 110*

1. The present Charter shall be ratified by the signatory states in accordance with their respective constitutional processes.

2. The ratifications shall be deposited with the Government of the United States of America, which shall notify all the signatory states of each deposit as well as the Secretary-General of the Organization when he has been appointed.

3. The present Charter shall come into force upon the deposit of ratifications by the Republic of China, France, the Union of Soviet Socialist Republics, the United Kingdom of Great Britain and Northern Ireland, and the United States of America, and by a majority of the other signatory states. A protocol of the ratifications deposited shall thereupon be drawn up by the Government of the United States of America which shall communicate copies thereof to all the signatory states.

4. The states signatory to the present Charter which ratify it after it has come

## *Politics among Nations*

into force will become original Members of the United Nations on the date of the deposit of their respective ratifications.

### *Article III*

The present Charter, of which the Chinese, French, Russian, English, and Spanish texts are equally authentic, shall remain deposited in the archives of the Government of the United States of America. Duly certified copies thereof shall be transmitted by that Government to the Governments of the other signatory states.

IN WITNESS WHEREOF the representatives of the Governments of the United Nations have signed the present Charter.

DONE at the city of San Francisco the twenty-sixth day of June, one thousand nine hundred and forty-five.

THE following countries have adhered to the Charter:

|                                                         |                                        |
|---------------------------------------------------------|----------------------------------------|
| CHINA                                                   | ICELAND                                |
| UNION OF SOVIET SOCIALIST REPUBLICS                     | IRAN                                   |
| UNITED KINGDOM OF GREAT BRITAIN<br>AND NORTHERN IRELAND | IRAQ                                   |
| UNITED STATES OF AMERICA                                | LEBANON                                |
| FRANCE                                                  | LIBERIA                                |
| AFGHANISTAN                                             | LUXEMBOURG                             |
| ARGENTINA                                               | MEXICO                                 |
| AUSTRALIA                                               | NETHERLANDS                            |
| BELGIUM                                                 | NEW ZEALAND                            |
| BOLIVIA                                                 | NICARAGUA                              |
| BRAZIL                                                  | NORWAY                                 |
| BYELORUSSIAN SOVIET SOCIALIST<br>REPUBLIC               | PAKISTAN                               |
| CANADA                                                  | PANAMA                                 |
| CHILE                                                   | PARAGUAY                               |
| COLOMBIA                                                | PERU                                   |
| COSTA RICA                                              | PHILIPPINE COMMONWEALTH                |
| CUBA                                                    | POLAND                                 |
| CZECHOSLOVAKIA                                          | SAUDI ARABIA                           |
| DENMARK                                                 | SIAM                                   |
| DOMINICAN REPUBLIC                                      | SWEDEN                                 |
| ECUADOR                                                 | SYRIA                                  |
| EGYPT                                                   | TURKEY                                 |
| EL SALVADOR                                             | UKRAINIAN SOVIET SOCIALIST<br>REPUBLIC |
| ETHIOPIA                                                | UNION OF INDIA                         |
| GREECE                                                  | UNION OF SOUTH AFRICA                  |
| GUATEMALA                                               | URUGUAY                                |
| HAITI                                                   | VENEZUELA                              |
| HONDURAS                                                | YEMEN                                  |
|                                                         | YUGOSLAVIA                             |

# BIBLIOGRAPHY

The purpose of this bibliography is to direct the reader to the most important and easily accessible literature on the general problems of international politics. Three limitations follow from this purpose. First, the bibliography is of necessity selective. Second, the voluminous literature dealing with special problems of international affairs, especially those that are regional, has not been considered. Third, main emphasis is placed upon publications in the English language.

## *Periodicals*

The following periodicals deal primarily with general problems of international politics:

*Foreign Affairs* (Council on Foreign Relations)  
*International Affairs* (Royal Institute of International Affairs)  
*International Conciliation* (Carnegie Endowment for International Peace)  
*International Journal* (Canadian Institute of International Affairs)  
*International Organization* (World Peace Foundation)  
*Quarterly Research Survey* (Pacifist Research Bureau)  
*World Politics* (Yale Institute of International Studies)

The following periodicals concern themselves from time to time with general problems of international politics:

*American Political Science Review*  
*American Journal of International Law*  
*The Annals of the American Academy of Political and Social Science*  
*British Yearbook of International Law*  
*Political Science Quarterly*  
*Review of Politics*

## *General Treatises on International Politics*

ARMSTRONG, HAMILTON FISH, editor. *The Foreign Affairs Reader*. New York: Harper & Brothers, 1947.  
BROWN, FRANCIS JAMES, HODGES, CHARLES, and ROUCEK, JOSEPH SLABEY, editors. *Contemporary World Politics*. New York: John Wiley & Sons, Inc., 1939.  
BRYCE, JAMES. *International Relations*. New York: The Macmillan Company, 1922.  
BUELL, RAYMOND LESLIE. *International Relations*. Revised edition. New York: Henry Holt and Company, 1929.



## Bibliography

- BURNS, C. DELISLE. *International Politics*. London: Methuen & Co., Ltd., 1920.
- HARLEY, JOHN EUGENE. *Documentary Textbook on International Relations*. Los Angeles: Suttonhouse, 1934.
- HEATLEY, D. P. *Diplomacy and the Study of International Relations*. Oxford: The Clarendon Press, 1919.
- HODGES, CHARLES. *The Background of International Relations*. New York: John Wiley & Sons, Inc., 1931.
- KALIJARVI, THORSTEN V. and ASSOCIATES. *Modern World Politics*. Second edition. New York: Thomas Y. Crowell Co., 1945.
- MANDER, LINDEN A. *Foundations of Modern World Society*. Second edition. Stanford University: Stanford University Press, 1947.
- MAXWELL, BERTRAM W. *International Relations*. New York: Thomas Y. Crowell Co., 1939.
- MIDDLEBUSH, FREDERICK A. and HILL, CHESNEY. *Elements of International Relations*. New York: McGraw-Hill Book Company, Inc., 1940.
- MOON, PARKER THOMAS. *Syllabus on International Relations*. New York: The Macmillan Company, 1925.
- MOWAT, R. B. *International Relations*. London: Rivingtons, 1931.
- RUSSELL, FRANK M. *Theories of International Relations*. New York: D. Appleton-Century Company, 1936.
- SCHUMAN, FREDERICK L. *International Politics*. Third edition. New York: McGraw-Hill Book Company, Inc., 1941.
- SCHWARZENBERGER, GEORG. *Power Politics*. London: Jonathan Cape, 1941.
- SHARP, WALTER R. and KIRK, GRAYSON. *Contemporary International Politics*. New York: Farrar & Rinehart, Inc., 1940.
- SIMONDS, FRANK H. and EMBENY, BROOKS. *The Great Powers in World Politics*. New edition. New York: American Book Company, 1939.
- SPROUT, HAROLD and MARGARET, editors. *Foundations of National Power*. Princeton: Princeton University Press, 1945.
- STEINER, H. ARTHUR. *Principles and Problems of International Relations*. New York: Harper & Brothers, 1940.
- WALSH, EDMUND A., editor. *The History and Nature of International Relations*. New York: The Macmillan Company, 1922.

For purposes of general reference, the following works are indispensable:

- Encyclopaedia of the Social Sciences*. New York: The Macmillan Company, 1932.
- WRIGHT, QUINCY. *A Study of War*. Two volumes. Chicago: University of Chicago Press, 1942.

## PART ONE

On the general nature of the study of international politics, see:

- GURIAN, WALDEMAR. "The Study of International Relations," *Review of Politics*, Vol. 8, No. 3 (July 1946), pp. 275-82.
- KIRK, GRAYSON. *The Study of International Relations*. New York: Council on Foreign Relations, 1947.
- WEBSTER, C. K. *The Study of International Politics*. Cardiff: University of Wales Press Board, 1923.

## Bibliography

For the intellectual problems to which the study of international politics gives rise, see:

- CARR, EDWARD HALLITT. *The Twenty Years' Crisis, 1919-1939*. London: Macmillan and Company, Limited, 1940.
- MORGLENTHAU, HANS J. *Scientific Man vs. Power Politics*. Chicago: University of Chicago Press, 1946.
- POSSONY, STEPHAN T. "The Limits of Post-War Planning," *Review of Politics*, Vol. 5, No. 1 (January 1943), pp. 103-20.
- ROMMEN, HANS. "Realism and Utopianism in World Affairs," *Review of Politics*, Vol. 6, No. 2 (April 1944), pp. 193-215.

## PART TWO

For the concept of political power, see:

- BRYSON, LYMAN, FINKELSTEIN, LOUIS, and MACIVER, R. M., editors. *Conflicts of Power in Modern Culture*. New York: Harper & Brothers, 1947.
- DUNN, FREDERICK S. *Peaceful Change*. New York: Council on Foreign Relations, 1937.
- GERTH, H. H. and MILLS, C. WRIGHT, editors. *From Max Weber: Essays in Sociology*. New York: Oxford University Press, 1946.
- LASSWELL, HAROLD D. *Politics: Who Gets What, When, How*. New York: Whittlesey House, 1936.
- MANNHEIM, KARL. *Man and Society in an Age of Reconstruction*. New York: Harcourt, Brace and Company, 1941.
- MERRIAM, CHARLES E. *Political Power: Its Composition and Incidence*. New York: Whittlesey House, 1934.
- PARSONS, ELSIE CLOUSE. *Social Rule: A Study of the Will to Power*. New York: G. P. Putnam's Sons, 1915.
- PARSONS, TALCOTT. *The Structure of Social Action*. New York: McGraw-Hill Book Company, Inc., 1937.
- , editor. *Max Weber: The Theory of Social and Economic Organization*. New York: Oxford University Press, 1947.
- RUSSELL, BERTRAND. *Power*. New York: W. W. Norton & Co., 1938.

Concerning the depreciation of political power, see in addition to the following books those by CARR and MORGENTHAU cited under Part One:

- BEARD, CHARLES A. *The American Spirit: A Study of the Idea of Civilization in the United States*. New York: The Macmillan Company, 1942.
- . *A Foreign Policy for America*. New York: Alfred A. Knopf, Inc., 1940.
- BEARD, CHARLES A. and MARY R. *The Rise of American Civilization*. Vol. II. New York: The Macmillan Company, 1927.
- BECKER, CARL L. *How New Will the Better World Be?* New York: Alfred A. Knopf, Inc., 1944.
- CURTI, MERLE. *The Growth of American Thought*. New York: Harper & Brothers, 1943.
- SILBERNER, EDWARD. *The Problem of War in Nineteenth Century Economic Thought*. New York: Oxford University Press, 1946.

## Bibliography

VAGTS, ALFRED. "The United States and the Balance of Power," *The Journal of Politics*, Vol. 3, No. 4 (November 1941), pp. 401-49.

For the general nature of international politics, see, in addition to the books cited under Part One:

FERRERO, GUGLILMO. *The Principles of Power: The Great Political Crises of History*. New York: G. P. Putnam's Sons, 1942.

LASSWELL, HAROLD D. *World Politics and Personal Insecurity*. New York: McGraw-Hill Book Company, Inc., 1935.

———. *World Politics Faces Economics*. New York: McGraw-Hill Book Company, Inc., 1945.

SPYKMAN, NICHOLAS. *America's Strategy in World Politics: The United States and the Balance of Power*. New York: Harcourt, Brace and Company, 1942.

STRAUSZ-HUPÉ, ROBERT. *The Balance of Tomorrow*. New York: G. P. Putnam's Sons, 1945.

WIGHT, MARTIN. *Power Politics*. London: Royal Institute of International Affairs, 1946.

For the different aspects of imperialism, see:

BEARD, CHARLES A. *The Devil Theory of War*. New York: The Vanguard Press, 1936.

BUKHARIN, NIKOLAI I. *Imperialism and World Economy*. New York: International Publishers, 1929.

DELAISI, FRANCIS. *Political Myths and Economic Realities*. New York: The Viking Press, 1927.

EINZIG, PAUL. *Bloodless Invasion*. London: Duckworth, 1938.

———. *Appeasement Before, During and After the War*. London: Macmillan and Company, Limited, 1941.

GROSS, LEO. *Paxifismus und Imperialismus*. Leipzig: F. Deuticke, 1931.

HANDMAN, MAX. "War, Economic Motives, and Economic Symbols," *The American Journal of Sociology*, Vol. 44, No. 5 (March 1939), pp. 629-48.

HASLIAGEN, JUSTUS. "Der Imperialismus als Begriff," *Weltwirtschaftliches Archiv*, Vol. 15, No. 2 (1919/20), pp. 157-91.

———. "Zur Deutung des Imperialismus," *Weltwirtschaftliches Archiv*, Vol. 26 (1927), II, pp. 134-51.

HOBSON, JOHN A. *Imperialism*. London: G. Allen and Unwin, 1938.

HOVDE, BRYNJOLF J. "Socialist Theories of Imperialism Prior to the Great War," *Journal of Political Economy*, Vol. 36, No. 5 (October 1928), pp. 569-91.

LANGER, WILLIAM L. *The Diplomacy of Imperialism*. New York: Alfred A. Knopf, Inc., 1935.

MARCK, SIEGFRIED. *Imperialismus und Paxifismus als Weltanschauungen*. Tübingen: J. C. B. Mohr, 1918.

MOON, PARKER THOMAS. *Imperialism and World Politics*. New York: The Macmillan Company, 1926.

NEARING, SCOTT. *The Tragedy of Empire*. New York: Island Press, 1945.

ROBBINS, LIONEL. *The Economic Causes of War*. London: Jonathan Cape, 1939.

———. *The Economic Problem in Peace and War: Some Reflections on Objectives and Mechanisms*. New York: The Macmillan Company, 1948.

SCHUMPETER, JOSEPH. "Zur Soziologie der Imperialisten," *Archiv für Sozialwissenschaft und Sozialpolitik*, Vol. 46, No. 1 (1918/19), pp. 1-39, 275-310.

## Bibliography

- . *Capitalism, Socialism, and Democracy*. Second edition. New York: Harper & Brothers, 1947.
- STALEY, EUGENE. *War and the Private Investor: A Study in the Relations of International Private Investment*. New York: Doubleday, Doran and Company, Inc., 1935.
- STERNBERG, FRITZ. *The Coming Crisis*. New York: The John Day Company, 1947.
- SULZBACH, WALTER. "Capitalist Warmongers" — *A Modern Superstition*. Chicago: University of Chicago Press, 1942.
- VINER, JACOB. "International Finance and Balance of Power Diplomacy, 1880-1914," *The Southwestern Political and Social Science Quarterly*, Vol. 9, No. 4 (March 1929), pp. 407-51.
- . "International Relations Between State-Controlled National Economies," *American Economic Review Supplement*, Vol. 34, No. 1 (March 1944), pp. 315-29.
- . "The Economic Problem." HUSZAR, GEORGE B. DE, editor. *New Perspectives on Peace*. Chicago: University of Chicago Press, 1944, pp. 85-114.
- WINSLOW, E. M. "Marxian, Liberal, and Sociological Theories of Imperialism," *The Journal of Political Economy*, Vol. 39, No. 6 (December 1931), pp. 713-58.
- . *The Pattern of Imperialism*. New York: Columbia University Press, 1948.

On the policy of prestige, see in addition to the following books the literature cited under Part Ten:

- DUNN, FREDERICK S. *Peaceful Change*. New York: Council on Foreign Relations, 1937.
- NICOLSON, HAROLD. *The Meaning of Prestige*. Cambridge: The University Press, 1947.

The fundamental work on political ideologies is:

- MANNHEIM, KARL. *Ideology and Utopia: An Introduction to the Sociology of Knowledge*, with a Preface by Louis Wirth. New York: Harcourt, Brace and Company, 1936.

## PART THREE

On national power in general, see:

- BALDWIN, HANSON W. *The Price of Power*. New York: Harper & Brothers, 1948.
- BEARD, CHARLES A. *The Idea of National Interest*. New York: The Macmillan Company, 1934.
- EMERY, BROOKS. *Mainsprings of World Politics*. New York: Foreign Policy Association Headline Series, No. 42, 1943.
- STRAUSZ-HUPÉ, ROBERT. *The Balance of Tomorrow*. New York: G. P. Putnam's Sons, 1945.

On nationalism, see:

- BARKER, ERNEST. *Christianity and Nationality*. London: Oxford University Press, 1927.

## Bibliography

- BARON, SALO WITTMAYER. *Modern Nationalism and Religion*. New York: Harper & Brothers, 1947.
- CARR, EDWARD HALLETT. *Nationalism and After*. New York: The Macmillan Company, 1945.
- CHADWICK, H. MUNRO. *The Nationalities of Europe and the Growth of National Ideologies*. New York: The Macmillan Company, 1946.
- COBBAN, ALFRED. *National Self-Determination*. Revised edition. Chicago: University of Chicago Press, 1948.
- FRIEDMANN, W. *The Crisis of the National State*. London: Macmillan and Company, Limited, 1943.
- GOOCH, GEORGE P. *Nationalism*. New York: Harcourt, Brace and Howe, 1920.
- HAYES, CARLETON J. *The Historical Evolution of Modern Nationalism*. New York: R. R. Smith, Inc., 1931.
- HERTZ, FREDERICK. *Nationality in History and Politics*. New York: Oxford University Press, 1944.
- HULA, ERIC. "National Self-Determination Reconsidered," *Social Research*, Vol. 10, No. 1 (February 1943), pp. 1-21.
- JANOWSKY, OSCAR I. *Nationalities and National Minorities*. New York: The Macmillan Company, 1945.
- KOHN, HANS. *The Idea of Nationalism*. New York: The Macmillan Company, 1944.
- LASKI, HAROLD J. *Nationalism and the Future of Civilization*. London: Watts and Company, 1932.
- ROYAL INSTITUTE OF INTERNATIONAL AFFAIRS. *Nationalism*. New York: Oxford University Press, 1946.
- STURZO, LUIGI. *Nationalism and Internationalism*. New York: Roy Publishers, 1946.
- SULZBACH, WALTER. *National Consciousness*. Washington: American Council on Public Affairs, 1943.
- WEST, REBECCA. *The Meaning of Treason*. New York: The Viking Press, 1947.
- WIRTH, LOUIS. "Types of Nationalism," *The American Journal of Sociology*, Vol. 41, No. 6 (May 1936), pp. 723-37.

On the different elements of national power, see:

- BARKER, ERNEST. *National Character and the Factors of its Formation*. London: Methuen & Co., Ltd., 1927.
- BENEDICT, RUTH. *The Chrysanthemum and the Sword*. Boston: Houghton Mifflin Company, 1946.
- BOWMAN, ISAIAH. *The New World: Problems in Political Geography*. Fourth edition. New York: World Book Company, 1928.
- BROGAN, D. W. *The American Character*. New York: Alfred A. Knopf, Inc., 1944.
- CARR-SAUNDERS, A. M. *World Population*. New York: Oxford University Press, 1936.
- COLBY, C. C., editor. *Geographic Aspects of International Relations*. Chicago: University of Chicago Press, 1938.
- EMERY, BROOKS. *The Strategy of Raw Materials*. New York: The Macmillan Company, 1934.
- FAIRGRIEVE, JAMES. *Geography and World Power*, Eighth edition. London: University of London Press, 1941.

- FRIEDENSBURG, FERDINAND. *Die mineralischen Bodenschätze als weltpolitische und militärische Machtfaktoren*. Stuttgart: Ferdinand Enke, 1936.
- GINI, CORRADO and OTHERS. *Population*. Chicago: University of Chicago Press, 1930.
- HARTSHORNE, RICHARD. *The Nature of Geography*. Ann Arbor: Edwards Brothers, 1946.
- HIRSCHMAN, ALBERT O. *National Power and the Structure of Foreign Trade*. Berkeley: University of California Press, 1945.
- LEITH, C. K. *World Minerals and World Politics*. New York: Whittlesey House, 1931.
- LEITH, C. K., FURNESS, J. W., and LEWIS, CLONA. *World Minerals and World Peace*. Washington: The Brookings Institution, 1943.
- MADARIAGA, SALVADOR. *Englishmen, Frenchmen, Spaniards*. Fourth edition. London: Oxford University Press, 1937.
- NOTESTEIN, F. W., TOENBER, IRENE B., and KIRK, DUDLEY. *The Future Population of Europe and the Soviet Union*. Geneva: League of Nations, 1944.
- RATZEL, FRIEDRICH. *Politische Geographie*. Second edition. München: Oldenburg, 1903.
- STALEY, EUGENE. *Raw Materials in Peace and War*. New York: Council on Foreign Relations, 1937.
- THOMPSON, WARREN S. *Population Problems*. Third edition. New York: McGraw-Hill Book Company, Inc., 1942.
- WEIGERT, HANS W. and STEFANSSON, VILHJALMUR. *Compass of the World*. New York: The Macmillan Company, 1944.
- WHITTLESEY, DERWENT. *The Earth and the State: A Study of Political Geography*. New York: Henry Holt and Company, 1939.
- . *German Strategy of World Conquest*. New York: Farrar & Rinehart, Inc., 1942.

On geopolitics, see:

- GYORGY, ANDREW. *Geopolitics*. Berkeley: University of California Press, 1944.
- HARTSHORNE, RICHARD. "Recent Developments in Political Geography," *American Political Science Review*, Vol. 29, Nos. 5 & 6 (October and December 1935), pp. 785-804, 943-66.
- MACKINDER, SIR HALFORD J. "The Geographical Pivot of History," *Geographical Journal*, Vol. 23 (1904), pp. 421-44.
- . *Democratic Ideals and Reality*. New York: Henry Holt and Company, 1942.
- MATTERN, JOHANNES. *Geopolitik: Doctrine of National Self-Sufficiency and Empire*. Baltimore: Johns Hopkins University Press, 1942.
- SPYKMAN, NICHOLAS J. *The Geography of the Peace*. New York: Harcourt, Brace and Company, 1944.
- STRAUSZ-HUPÉ, ROBERT. *Geopolitics*. New York: G. P. Putnam's Sons, 1942.
- WEIGERT, HANS W. *German Geopolitics*. New York: Oxford University Press, 1942.
- . *Generals and Geographers*. New York: Oxford University Press, 1942.

## Bibliography

### PART FOUR

On the theory of the balance of power, see:

- DONNADIEU, LÉONCE. *Essai sur la théorie d'équilibre*. Paris: A. Rousseau, 1900.
- DUPUIS, CHARLES. *Le Principe d'équilibre et le Concert Européen*. Paris: Perrin et C<sup>ie</sup>, 1909.
- FRIEDRICH, CARL JOACHIM. *Foreign Policy in the Making*. New York: W. W. Norton & Co., 1938.
- GULICK, EDWARD VOSE. *The Balance of Power*. Philadelphia: The Pacifist Research Bureau, 1943.
- HOIJER, OLAF. *La Théorie d'équilibre*. Paris: A. Pedone, 1917.
- HUME, DAVID. "Of the Balance of Power," *Essays Moral and Political*. Third edition. London, 1748.
- KAEBER, E. *Die Idee des europäischen Gleichgewichts in der publizistischen Literatur vom 16. bis zur Mitte des 18. Jahrhunderts*. Berlin: A. Duncker, 1907.
- NYS, ERNEST. "La Théorie d'équilibre Européen," *Revue de droit international et de législation comparée*, Vol. 25 (1893), pp. 34-57.
- PHILLIMORE, SIR ROBERT. *Commentaries upon International Law*. Second edition. Vol. I. London: Butterworths, 1871.
- PRIBRAM, KARL. "Die Idee des Gleichgewichtes in der älteren nationalökonomischen Theorie," *Zeitschrift für Volkswirtschaft*, Vol. 17, Part I (1908), pp. 1-28.
- RÉAL DE CURBAN, GASPARD. *La Science du gouvernement*. Vol. 6. Aix-la-Chapelle, 1765.
- SPYKMAN, NICHOLAS. *America's Strategy in World Politics*. New York: Harcourt, Brace and Company, 1942.
- STIEGLITZ, ALEXANDRE DE. *De l'Équilibre politique, du légitimisme et du principe des nationalités*. Vol. III. Paris: Pédone-Lauriel, 1893.
- TANNENBAUM, FRANK. "The Balance of Power in Society," *Political Science Quarterly*, Vol. 61, No. 4 (December 1946), pp. 481-504.
- TOYNBEE, ARNOLD J. *The World After the Paris Conference*. New York: Oxford University Press, 1925.
- . *A Study of History*. Vol. 3. New York: Oxford University Press, 1934.

On the classic Indian theory of power politics and the balance of power, see:

- KAUTILYA. *Arthśāstra*. Translated by R. Shamasastri. Mysore: Wesleyan Mission Press, 1929.
- LAW, NARENDRA NATH. *Interstate Relations in Ancient India*. London: Luzac and Company, 1920.
- NÂG, KALIDAS. *Les Théories diplomatiques de l'Inde ancienne et l'Arthasāstra*. Paris: Jouve et C<sup>ie</sup>, 1923.

For the history of the balance of power, see:

- GRANT, A. J. and TEMPERLEY, HAROLD. *Europe in the Nineteenth and Twentieth Centuries (1789-1939)*. New York: Longmans, Green & Co., 1940.
- LANGER, WILLIAM L. *The Diplomacy of Imperialism*. New York: Alfred A. Knopf, Inc., 1935.
- . *European Alliances and Alignments, 1871-1890*. New York: Alfred A. Knopf, Inc., 1931.

## Bibliography

- PETRIE, SIR CHARLES. *Diplomatic History, 1713-1933*. London: Hollis and Carter, Ltd., 1946.
- POTILMKINE, VLADIMIR. *Histoire de la diplomatie*. Three volumes. Paris: Librairie de Médecis, 1946-7.
- SCHMITT, BERNADOTTE F. *Triple Alliance and Triple Entente*. New York: Henry Holt and Company, 1934.
- SETON-WATSON, ROBERT W. *Britain in Europe, 1789-1914*. New York: The Macmillan Company, 1937.
- SONTAG, RAYMOND J. *European Diplomatic History*. New York: The Century Co., 1933.
- TEMPERLEY, HAROLD. *The Foreign Policy of Canning, 1822-1827: England, the Neo-Holy Alliance, and the New World*. London: G. Bell and Sons, Ltd., 1925.
- WEBSTER, CHARLES K. *The Foreign Policy of Castlereagh, 1812-1815*. London: G. Bell and Sons, Ltd., 1931.
- WINDELBAND, WOLFGANG. *Die auswärtige Politik der Grossmächte in der Neuzeit (1494-1919)*. Stuttgart: Deutsche Verlagsanstalt, 1922.
- WOLFERS, ARNOLD. *Britain and France between Two Wars*. New York: Harcourt, Brace and Company, 1940.

## PART FIVE

For the general problem of rules of conduct, see:

- MOROGENTHAU, HANS J. *La Réalité des normes*. Paris: Librairie Félix Alcan, 1934.
- TIMASHEFF, N. S. *An Introduction to the Sociology of Law*. Cambridge: Harvard University Committee on Research in the Social Sciences, 1939.

On the problem of international morality, see:

- BOSANQUET, BERNARD. *The Philosophical Theory of the State*. New York: The Macmillan Company, 1899.
- CARR, EDWARD HALLETT. *Conditions of Peace*. New York: The Macmillan Company, 1944.
- HUIZINGA, J. H. "On the High Cost of International Moralizing," *The Fortnightly Review*, Vol. 156, New series (November 1944), pp. 295-300.
- KRAUS, HERBERT. "La Morale internationale," *Hague Academy of International Law. Recueil des cours*, Vol. 16 (1927), pp. 389-539.
- LINDSAY, A. V. *The Modern Democratic State*. New York: Oxford University Press, 1947.
- NIEBUHR, REINHOLD. *Moral Man and Immoral Society: A Study in Ethics and Politics*. New York: C. Scribner's Sons, 1932.
- . *Christianity and Power Politics*. New York: C. Scribner's Sons, 1940.
- . "Democracy as a Religion," *Christianity and Crisis*, Vol. 7, No. 14 (August 4, 1947), pp. 1-2.
- POLITIS, NICOLAS. *La Morale internationale*. New York: Brentano's, 1944.
- THOMPSON, J. W. and PADOVER, S. K. *Secret Diplomacy: A Record of Espionage and Double Dealing, 1500-1815*. London: Jarrolds, Ltd., 1937.
- WELDON, T. D. *States and Morals*. New York: McGraw-Hill Book Company, Inc., 1947.
- WEST, RANYARD. *Conscience and Society*. New York: Emerson Books, 1945.



## Bibliography

See also the books by CARR and MORGENTHAU cited under Part One.  
On nationalistic universalism, consult the books in Part Three under *Nationalism*.

On world public opinion, see:

- DICEY, A. V. *Lectures on the Relation between Law and Public Opinion in England during the Nineteenth Century*. London: Macmillan and Company, 1914.
- FERRERO, GUGLIELMO. *The Unity of the World*. London: Jonathan Cape, 1931.
- LASSWELL, HAROLD D. *World Politics and Personal Insecurity*. New York: Whitesey House, 1935.
- LIPPMANN, WALTER. *Public Opinion*. New York: The Macmillan Company, 1922.
- LOWELL, A. LAWRENCE. *Public Opinion and Public Government*. New York: Longmans, Green & Co., 1914.
- . *Public Opinion in War and Peace*. Cambridge: Harvard University Press, 1926.
- SCHINDLER, DIETRICH. "Contribution a l'étude des facteurs sociologiques et psychologiques du droit international," *Hague Academy of International Law. Recueil des cours*, Vol. 46 (1933), pp. 231-322.
- SMITH, CHARLES W. *Public Opinion in a Democracy*. New York: Prentice-Hall, 1939.
- STRATTON, GEORGE MALCOMB. *Social Psychology of International Conduct*. New York: D. Appleton and Company, 1929.

## PART SIX

for the general problems of international law, see:

- BENTWICH, NORMAN. *International Law*. London: Royal Institute of International Affairs, 1945.
- BRIERLY, J. L. *The Law of Nations*. Third edition. Oxford: The Clarendon Press, 1942.
- . *The Outlook for International Law*. Oxford: The Clarendon Press, 1944.
- DICKINSON, EDWIN D. *What Is Wrong with International Law?* Berkeley: James J. Gillick and Company, 1947.
- HUBER, MAX. *Die soziologischen Grundlagen des Völkerrechts*. Berlin: Dr. Walter Rothschild, 1928.
- JESSUP, PHILIP C. *A Modern Law of Nations*. New York: The Macmillan Company, 1948.
- KEETON, GEORGE W. and SCHWARZENBERGER, GEORG. *Making International Law Work*. Second edition. London: Stevens & Sons, Limited, 1946.
- LAUTERPACHT, H. *The Function of Law in the International Community*. Oxford: The Clarendon Press, 1933.
- MOORE, JOHN BASSETT. *International Law and Some Current Illusions*. New York: The Macmillan Company, 1924.
- MORGENTHAU, HANS J. "Positivism, Functionalism, and International Law," *American Journal of International Law*, Vol. 34 (April 1940), pp. 260-84.
- ROYAL INSTITUTE OF INTERNATIONAL AFFAIRS. *International Sanctions*. London, New York, and Toronto: Oxford University Press, 1938.

## Bibliography

- SCHWARZENBERGER, GEORG. *A Manual of International Law*. London: Stevens & Stevens, Limited, 1947.
- STARKL, J. G. *Introduction to International Law*. London: Butterworths and Company, Ltd., 1947.
- WILLIAMS, SIR JOHN FISCHLR. *Chapters on Current International Law and the League of Nations*. New York: Longmans, Green & Co., 1929.
- . *Aspects of Modern International Law*. New York: Oxford University Press, 1939.

On special problems connected with the Covenant of the League of Nations and the Charter of the United Nations, see the books cited under Part Eight. On sovereignty, see:

- CORWIN, EDWARD S. *The President: Office and Powers*. Second edition. New York: New York University Press, 1941.
- . *Total War and the Constitution*. New York: Alfred A. Knopf, Inc., 1947.
- DICKINSON, EDWIN D. *The Equality of States in International Law*. Cambridge: Harvard University Press, 1920.
- . "A Working Theory of Sovereignty," *Political Science Quarterly*, Vol. 42, No. 4 (December 1927), pp. 524-48; Vol. 43, No. 1 (March 1928), pp. 1-31.
- DUGUIT, LÉON. *Law in the Modern State*. New York: B. W. Huesch, 1919.
- KERTON, GEORGE W. *National Sovereignty and International Order*. London: Peace Book Company, 1939.
- KELSEN, HANS. *General Theory of Law and State*. Cambridge: Harvard University Press, 1945.
- . *Das Problem der Souveränität und die Theorie des Völkerrechts*. Tübingen: J. C. B. Mohr, 1920.
- KOO, WELLINGTON, JR. *Voting Procedures in International Organizations*. New York: Columbia University Press, 1947.
- KRABBE, H. *The Modern Idea of the State*. New York: D. Appleton and Company, 1922.
- LASKI, HAROLD J. *Studies in the Problem of Sovereignty*. New Haven: Yale University Press, 1917.
- . *Authority in the Modern State*. New Haven: Yale University Press, 1919.
- . *The Foundations of Sovereignty and Other Essays*. London: G. Allen and Unwin, 1921.
- MATERN, JOHANNES. *Concepts of State, Sovereignty and International Law*. Baltimore: Johns Hopkins Press, 1928.
- MERRIAM, CHARLES E. *History of the Theory of Sovereignty since Rousseau*. New York: Columbia University Press, 1900.
- RICHES, CROMWELL A. *Majority Rule in International Organizations*. Baltimore: Johns Hopkins Press, 1940.

## PART SEVEN

On the general nature of contemporary world politics, see:

- ARMSTRONG, HAMILTON FISH. *The Calculated Risk*. New York: The Macmillan Company, 1947.
- CARR, EDWARD HALLETT. *Conditions of Peace*. New York: The Macmillan Company, 1944.

## Bibliography

- FISCHLER, ERIC. *The Passing of the European Age*. Cambridge: Harvard University Press, 1943.
- FOX, WILLIAM T. R. *The Super-Powers*. New York: Harcourt, Brace and Company, 1944.
- LIPPMANN, WALTER. *U. S. Foreign Policy*. Boston: Little, Brown and Company, 1943.
- . *U. S. War Arms*. Boston: Little, Brown and Company, 1944.
- . *The Cold War*. New York: Harper & Brothers, 1947.
- STRAUSZ-HUPÉ, ROBERT. *The Balance of Tomorrow*. New York: G. P. Putnam's Sons, 1945.
- VINER, JACOB. "The Implications of the Atomic Bomb for International Relations," *Proceedings of the American Philosophical Society*, Vol. 90, No. 1 (Philadelphia, 1946), pp. 53-8.
- WELLES, SUMNER. *Where Are We Heading?* New York: Harper & Brothers, 1946.
- YALE INSTITUTE OF INTERNATIONAL STUDIES (William T. R. Fox, rapporteur). *United States Policy in a Two-Power World*. New Haven: Yale Institute of International Studies, 1947.

On total war, see:

- BRODIE, BERNARD. *Sea Power in the Machine Age*. Princeton: Princeton University Press, 1941.
- , editor. *The Absolute Weapon: Atomic Power and World Order*. New York: Harcourt, Brace and Company, 1946.
- CLARKSON, JESSE and COCHRAN, THOMAS C., editors. *War as a Social Institution*. New York: Columbia University Press, 1941.
- EARLE, EDWARD M. LEAD, editor. *Makers of Modern Strategy*. Princeton: Princeton University Press, 1944.
- FERRERO, GUGLIELMO. *Peace and War*. London: Macmillan and Company, Limited, 1933.
- HART, B. H. LIDDELL. *The Revolution in Warfare*. London: Faber & Faber, Ltd., 1946.
- MUMFORD, LEWIS. *Techniques and Civilization*. New York: Harcourt, Brace and Company, 1934.
- OGBURN, WILLIAM FIELDING. *The Social Effects of Aviation*. Boston: Houghton Mifflin Company, 1946.
- OMAN, SIR CHARLES. *A History of the Art of War in the Sixteenth Century*. New York: E. P. Dutton and Company, 1937.
- SCHULTZ, THEODORE W. "Changes in the Economic Structure Affecting American Agriculture," *Journal of Farm Economics*, Vol. 28, No. 1 (February 1946), pp. 15-27.
- SPAULDING, O. L., NICKERSON, HOFFMAN, and WRIGHT, J. W. *Warfare*. New York: Harcourt, Brace and Company, 1925.
- SPEIER, HANS. " Militarism in the Eighteenth Century," *Social Research*, Vol. 3, No. 3 (August 1936), pp. 305-36.
- . "Class Structure and 'Total War,'" *American Sociological Review*, Vol. 4, No. 3 (June 1939), pp. 370-80.
- SPEIER, HANS and KAHLER, ALFRED, editors. *War in Our Time*. New York: W. W. Norton & Co., 1939.
- VAGTS, ALFRED. *A History of Militarism*. New York: W. W. Norton & Co., 1937.
- WOODWARD, E. L. *Some Political Consequences of the Atomic Bomb*. New York: Oxford University Press, 1946.

## PART EIGHT

On the history of peace plans, see:

- HILMLEBIN, SYLVESTER JOHN. *Plans for World Peace through Six Centuries*. Chicago: University of Chicago Press, 1945.
- LANGÉ, CHRISTIAN. *Histoire de l'internationalisme*. New York: G. P. Putnam's Sons, 1919.
- MARRIOTT, J. A. R. *Commonwealth or Anarchy? A Survey of Projects of Peace from the Sixteenth to the Twentieth Century*. New York: Columbia University Press, 1939.
- PAULLIN, THEODORE. *Comparative Peace Plans*. Philadelphia: Pacifist Research Bureau, 1943.
- SOULLYMAN, ELIZABETH V. *The Vision of World Peace in Seventeenth- and Eighteenth-Century France*. New York: G. P. Putnam's Sons, 1941.
- WYNNER, EDITH and LLOYD, GEORGIA. *Searchlights on Peace Plans*. New York: E. P. Dutton and Company, 1944.

On disarmament, see:

- BUELL, RAYMOND LESLIE. *The Washington Conference*. New York: D. Appleton and Company, 1922.
- GRISWOLD, A. WHITNEY. *The Far Eastern Policy of the United States*. New York: Harcourt, Brace and Company, 1938.
- MORGAN, LAURA PUFFER. *The Problem of Disarmament*. New York: Commission to Study the Organization of Peace, 1947.
- POSSONY, STEPHEN T. "No Peace Without Arms," *The Review of Politics*, Vol. 6, No. 2 (April 1944), pp. 216-27.
- SHILS, EDWARD A. *Atomic Bombs in World Politics*. London: National Peace Council, 1948.
- TATE, MERZL. *The Disarmament Illusion*. New York: The Macmillan Company, 1942.
- . *The United States and Armaments*. Cambridge: Harvard University Press, 1948.
- WHEELER-BENNETT, JOHN. *The Pipe-Dream of Peace: The Story of the Collapse of Disarmament*. New York: William Morrow and Company, 1935.
- WOODWARD, E. L. *Some Political Consequences of the Atomic Bomb*. New York: Oxford University Press, 1946.

On security, see:

- JESSUP, PHILIP C. *International Security*. New York: Council on Foreign Relations, 1935.
- MITRANY, DAVID. *The Problem of International Sanctions*. New York: Oxford University Press, 1925.
- ROYAL INSTITUTE OF INTERNATIONAL AFFAIRS. *International Sanctions*. London: Oxford University Press, 1938.
- WILD, PAYSON S. *Sanctions and Treaty Enforcement*. Cambridge: Harvard University Press, 1934.

## Bibliography

On judicial settlement, see:

- KELSEN, HANS. *Peace through Law*. Chapel Hill: University of North Carolina Press, 1944.
- LAUTERPACHT, H. *The Function of Law in the International Community*. Oxford: The Clarendon Press, 1933.
- MORGENTHAU, HANS J. *La Notion du "politique" et la théorie des différends internationaux*. Paris: Librairie du Recueil Sirey, 1933.
- SCHINDLER, DIETRICH. *Die Schiedsgerichtsbarkeit seit 1914*. Stuttgart: W. Kohlhammer, 1938.

For peaceful change, see in addition to the titles under international government the following book:

- DUNN, FREDERICK S. *Peaceful Change*. New York: Council on Foreign Relations, 1937.

On international government, see:

- BARKER, ERNEST. *The Confederation of Nations*. Oxford: The Clarendon Press, 1918.
- BRIERLEY, J. L. *The Covenant and the Charter*. Cambridge: The University Press, 1947.
- BRIGGS, HILBERT W. "Power Politics and International Organization," *American Journal of International Law*, Vol. 39, No. 4 (October 1945), pp. 664-79.
- BURTON, MARGARET E. *The Assembly of the League of Nations*. Chicago: University of Chicago Press, 1941.
- CONWELL, EVANS, T. P. *The League Council in Action*. London: Oxford University Press, 1929.
- CORBETT, PERCY E. *Post-War Worlds*. Los Angeles: Institute of Pacific Relations, 1942.
- DAVIS, HARRIET EAGER, editor. *Pioneers in World Order*. New York: Columbia University Press, 1944.
- DELL, ROBERT. *The Geneva Racket, 1920-1939*. London: Robert Hale, Ltd., 1940.
- DOLIVET, LOUIS. *The United Nations*. New York: Farrar, Straus and Company, 1946.
- EAGLETON, CLYDE. *International Government*. Revised edition. New York: The Ronald Press Company, 1948.
- EVATT, HERBERT VERE. *The United Nations*. Cambridge: Harvard University Press, 1948.
- FREEMAN, HARROP A. "The United Nations Organization and International Law," *Cornell Law Quarterly*, Vol. 31, No. 3 (March 1946), pp. 259-84.
- . *Coercion of States in International Organizations*. Philadelphia: The Pacifist Research Bureau, 1944.
- FREEMAN, HARROP A. and PAULLIN, THEODORE. *Coercion of States in Federal Unions*. Philadelphia: The Pacifist Research Bureau, 1943.
- FRIEDRICH, CARL JOACHIM. *Foreign Policy in the Making*. New York: W. W. Norton & Co., 1938.
- . *Inevitable Peace*. Cambridge: Harvard University Press, 1948.
- GOODRICH, LELAND M. and HAMBRO, EDVARD. *Charter of the United Nations: Commentary and Documents*. Boston: World Peace Foundation, 1946.
- HANKEY, LORD MAURICE P. *Diplomacy by Conference*. New York: G. P. Putnam's Sons, 1946.
- HARLEY, J. EUGENE. *Documentary Textbook on the United Nations*. Los Angeles: Center for International Understanding, 1947.

## Bibliography

- MCCALLUM, R. B. *Public Opinion and the Last Peace*. New York: Oxford University Press, 1944.
- MORGENTHAU, HANS J., editor. *Peace, Security, and the United Nations*. Chicago: University of Chicago Press, 1946.
- MORLEY, FELIX. *The Society of Nations*. Washington: The Brookings Institution, 1932.
- NICOLSON, HAROLD. *The Congress of Vienna: A Study in Allied Unity, 1812-1822*. New York: Harcourt, Brace and Company, 1946.
- NYE, M. ERNEST. "Le Concert Européen et la notion du droit international," *Revue de droit international*, Deuxième Série, Vol. 1 (1899), pp. 273-313.
- OPPENHEIM, L. *The League of Nations and Its Problems*. London: Longmans, Green & Co., 1919.
- PHILLIPS, WALTER ALISON. *The Confederation of Europe*. London: Longmans, Green & Co., 1914.
- POTTER, PITMAN B. *An Introduction to the Study of International Organization*. Fifth edition. New York: Appleton-Century-Crofts, Inc., 1948.
- RAY, JEAN. *Commentaire du Pacte de la Société des Nations*. Paris: Recueil Sirey, 1930.
- SCHENK, H. G. *The Aftermath of the Napoleonic Years: The Concert of Europe — an Experiment*. New York: Oxford University Press, 1948.
- "Symposium on World Organization," *The Yale Law Journal*, Vol. 55, No. 5 (August 1946).
- VINACKI, HAROLD M. *International Organization*. New York: F. S. Crofts & Co., 1934.
- WOOLF, L. S. *International Government*. New York: Brentano's, 1916.
- World Organization: A Balance Sheet of the First Great Experiment*. Washington: American Council on Public Affairs, 1942.
- ZIMMERN, SIR ALFRED E. *The League of Nations and the Rule of Law*. New York: The Macmillan Company, 1939.

See also the books by TEMPERLEY, WEBSTER, and WOLFERS, cited under Part Four.

## PART NINE

On the problem of the world state, see:

- BRINTON, CRANE. *From Many One: The Process of Political Integration. The Problem of World Government*. Cambridge: Harvard University Press, 1948.
- EWING, ALFRED C. *The Individual, the State, and World Government*. New York: The Macmillan Company, 1947.
- GUERRARD, ALBERT. "The World Comes of Age," *The Nation*, Vol. 162, No. 16 (April 20, 1946), pp. 457-9.
- LEWIS, EDWARD R. "Are We Ready for a World State?" *The Yale Review*, Vol. 35, No. 3 (March 1946), pp. 491-501.
- MARRIOTT, T. A. R. *Federalism and the Problem of the Small State*. London: G. Allen and Unwin, 1943.
- MARTIN, WILLIAM. *A History of Switzerland*. London: Grant Richards, 1931.
- MEYER, CORD. *Peace or Anarchy*. Boston: Little, Brown and Company, 1947.
- NÄF, WERNER. *Die Schweiz in Europa*. Bern: Herbert Lang and Company, 1938.
- NIEBUHR, REINHOLD. "The Myth of World Government," *The Nation*, Vol. 162, No. 11 (March 16, 1946), pp. 312-14.

## Bibliography

- PILCOVITS, N. A. "World Government Now?" *Harper's*, Vol. 193, No. 1156 (November 1946), pp. 396-403.
- RAPPARD, WILLIAM E. *Cinq siècles de sécurité collective, 1291-1798*. Paris: Recueil Sirey, 1945.
- REVES, EMLRY. *The Anatomy of Peace*. New York: Harper & Brothers, 1946.
- RIDER, FREMONT. *The Great Dilemma of World Organization*. New York: Reynal & Hitchcock, 1946.

On the problem of the world community, see:

- FINER, HERMAN. *The United Nations Economic and Social Council*. Boston: The World Peace Foundation, 1946.
- FREEMAN, HARROP A. and PAULLIN, THEODORE. *Road to Peace: A Study in Functional International Organization*. Ithaca: The Pacifist Research Bureau, 1947.
- IUSZAR, GEORGE B. DL, editor. *New Perspectives on Peace*. Chicago: University of Chicago Press, 1944.
- , editor. *Persistent International Issues*. New York and London: Harper & Brothers, 1947.
- HUXLEY, JULIAN. *UNESCO*. Washington: Public Affairs Press, 1947.
- JAMLS, WILLIAM. *A Moral Equivalent for War*. New York: Carnegie Endowment for International Peace, 1926.
- McMURRY, RUTH EMILY and LEE, MUNA. *The Cultural Approach: Another Way in International Relations*. Chapel Hill: University of North Carolina Press, 1947.
- MITRANY, DAVID. *A Working Peace System*. London: Royal Institute of International Affairs, 1944.
- MURPHY, GARDNER, editor. *Human Nature and Enduring Peace*. New York: Reynal and Hitchcock, Inc., 1945.
- SHARP, WALTER R. "The Specialized Agencies and the United Nations: Progress Report I," *International Organization*, Vol. I, No. 3 (September 1947), pp. 460-74.
- WRIGHT, QUINCY, editor. *The World Community*. Chicago: University of Chicago Press, 1948.

## PART TEN

On the problems of diplomacy, see:

- BEARD, CHARLES A. *The Idea of National Interest*. New York: The Macmillan Company, 1934.
- CALLIÈRES, FRANÇOIS DE. *On the Manner of Negotiating with Princes*. Boston: Houghton Mifflin Co., 1919.
- CAMBON, JULES. *Le Diplomate*. Paris: Hachette, 1926.
- CHAMBRUN, CHARLES DE. *L'Esprit de la diplomatie*. Paris: Editions Corrèa, 1944.
- FOSTER, JOHN W. *The Practice of Diplomacy*. Boston: Houghton Mifflin Company, 1906.
- FRIEDRICH, CARL JOACHIM. *Foreign Policy in the Making*. New York: W. W. Norton & Co., 1938.
- HEATLEY, DAVID PLAYFAIR. *Diplomacy and the Study of International Relations*. Oxford: The Clarendon Press, 1919.

## Bibliography

- JONES, JOSEPH M. *A Modern Foreign Policy for the United States*. New York: The Macmillan Company, 1944.
- JUSSEFAND, JEAN A. *The School for Ambassadors and Other Essays*. New York: G. P. Putnam's Sons, 1925.
- LIPPMANN, WALTER. *The Stakes of Diplomacy*. New York: Henry Holt and Company, 1917.
- MABLY, ABBÉ GABRIEL BONNET DE. "Principes des négociations," *Collection complète des oeuvres de l'Abbé de Mably*. Vol. 5. Paris: 1794-5.
- MORLEY, JOHN VISCOUNT. *On Compromise*. London: Macmillan and Company, Limited, 1923.
- MOWLER, PAUL SCOTT. *Our Foreign Affairs: A Study in National Interest and the New Diplomacy*. New York: E. P. Dutton and Company, 1924.
- NICOLSON, HAROLD G. *Diplomacy*. London: T. Butterworth, 1939.
- ONCKEN, HERMANN. *Politik und Kriegsführung*. Munich: Max Huber, 1928.
- REDLICH, MARCELLUS D. *International Law as a Substitute for Diplomacy*. Chicago: Independent Publisher Co., 1928.
- REINSCH, PAUL S. *Secret Diplomacy*. New York: Harcourt, Brace and Company, 1922.
- WILLIAMS, JOSEPH H. "Social Adjustments to Atomic Energy," *Proceedings of the American Philosophical Society*, Vol. 90, No. 1 (Philadelphia, 1946), pp. 48-52.
- YOUNG, GEORGE. *Diplomacy Old and New*. London: Swarthmore Press, 1921.



# INDEX

- Adamses, diplomacy of the, 107  
Adjudication, *see* International Courts  
Air force, influence upon distribution of power, 89 ff. *See also* Revolution, Technology, Total war  
Aix-la-Chapelle, Congress of (1818), 363, 367  
Alabama claims, 220, 225  
Alaska, acquisition of, by United States (1867), 25  
Albani, Eugenio, 144*n*  
Alexander I of Russia: advised by members of international aristocracy, 186; and Holy Alliance, 362, 365 ff.  
Alexander the Great, and imperialism, 31, 32, 36, 42, 48  
Allec, Warder, 17*n*  
Alliance, between Brazil and Uruguay (1851), 147; Austro-German (1879), 24; Franco-Russian (1894), 24, 46, 54, 106; Franco-British (1912), 153, 154; British-Japanese, dissolution of (1922), 316; Franco-Russian (1935), 142, 373*n*. *See also* Triple Alliance, Triple Entente, world wars, major powers  
Alliances of France, after First World War, 24, 35, 142, 318, 372; of Soviet Union after Second World War, 24  
Alliances, ideological disguise of, 64; as instruments of status quo, 24, 318, 372; as method of balance of power, 137 ff., 153 ff., 318; as restraints on national policies, 271 ff.; risks for great powers, 442  
*American Banana Co. vs. United Fruit Co.*, on sovereignty, 250*n*  
American Century, 115  
American Civil War, more important for United States than international affairs, 7, 8. *See also* Peaceful change, Technology, Tension  
American Constitution, interpretation, 217, 219, 220  
Angell, Norman, on war, 33  
Anglo-German Naval Agreement (1935), 314, 316, 317, 325, 326. *See also* Disarmament  
Anzilotti, Judge: on international law of maritime belt, 214; on political character of Austro-German Customs Union Case, 348  
Appeasement, 43 ff.  
Arab policy, with regard to Palestine, 357, 360  
Arbitration, international: concept, 220*n*; institutional, 221; isolated, 220. *See also* International Courts  
Arbitration Movement, 341  
Argentina, *see* topical headings  
Aristocracy, international cohesion in eighteenth century, 185 ff.  
Armaments, as method of balance of power, 136, 137, 151, 152, 156, 157, 314, 315, 327, 330. *See also* Balance of Power, Disarmament  
Armies, influence of size on character of war, 292, 293, 301, 302. *See also* Total war, War  
Armstrong, Hamilton F., 473, 483  
Artillery, influence on distribution of power, 89, 91. *See also* Frederick the Great, Napoleon, Technology  
Atlantic Charter, 97, 194  
Atomic bomb, influence on distribution of power, 81, 90, 319; and international morality, 192; tests and policy of prestige, 54  
Atomic Development Authority, 252 ff.; veto against its decisions, 254, 255; and world government, 253, 255  
Atomic energy, international control, 252 ff.; influence on national power, 109, 110, 115; revolution in warfare, 296, 297. *See also* Disarmament, United Nations Atomic Energy Commission, United States  
Atomic war, potentialities, 319 ff.  
Atomic weapons, compared with traditional ones, 319, 320  
Augustus: and imperialism, 28; and population decrease, 94  
Australia, *see* topical headings  
Austria, diplomacy on eve of First World War, 442; traditional foreign policy, 278; independence and balance of power, 133, 146 ff. *See also* World War, First, topical headings  
Austro-German Customs Union Case, political character of, 347, 348  
Austro-Prussian War (1866), 146 ff.; and imperialism, 31  
Axis, of Germany, Italy, and Japan (1936), 142  
Bacon, Francis, on balance of power, 138  
Balance of power, 125 ff., 270 ff.; African, 147; in American government, 127 ff.; amorality in eighteenth century: 139, as practiced by Great Britain, 143 and by Italy, 144; and Balkans, 133, 140 ff., 146, 149, 282, 284; and Belgium, 133, 141, 162; bipolar between United States and Soviet Union, 149, 157, 272, 284 ff., 305, 430, 438, 440; general character-

## Index

### Balance of power (*continued*)

- tics; in eighteenth century, 139 and in mid-twentieth century, 148, 149, 270 ff.; center no longer in Europe, 148, 149, 284, 376; and collective security, 142, 332 ff.; and disappearance of colonial frontier, 278 ff.; concept, 125, 126, 151; inner contradiction, 131, 150; criterion for measuring, 151 ff.; criticized by Manchester liberals, 145; different in international and domestic politics, 127*n*; as dogma, 145; in domestic politics, 127 ff.; dominant and dependent systems, 146 ff.; Eastern, 146; European, as function of world-wide system, 149, 284; expansion from Europe to world, 139, 140, 148, 149, 284; in Far East, 147, 149; flexibility, 271 ff.; two functions, 129 ff.; German, 133, 146 ff.; "holder" or balancer, 143 ff., 273 ff.; inevitability, 125, 150; instability, 131, 150; in Italy in sixteenth century, 138, 144, 146, 147; and League of Nations, 142; methods, 134 ff.; and moral consensus of Western Civilization, 160 ff., 267; and national independence, 129 ff., 143, 150, 157, 159 ff.; in Near East, 147, 149; and neutrals, 273; Northern, 146; influence of number of participants, 270 ff.; two typical patterns, 130 ff., 142, 143; and prevention of war, 156, 157; and preventive war, 155, 156; as restraint on national policies, 271 ff., 278; self-restraint as precondition for, 164, 165; as protection of small nations, 131 ff., 150, 165*n*, 273; as general social principle, 125 ff.; and international stability, 129 ff., 150, 159 ff.; structure, 146 ff., 270 ff., 376; as struggle for supremacy, 155 ff.; and Switzerland, 404, 405; uncertainty, 142, 151 ff., 271 ff.; unreality, 155 ff.; and world empire, 132 ff., 150, 157. *See also* Equilibrium, Holy Alliance, League of Nations, United Nations, World Wars, major powers
- Baldwin, Hanson W., 477
- Baldwin, Stanley, influence on British power, 107
- Balkans, divided by Anglo-Russian agreement of 1944, 386. *See also* Balance of power, World War, First, major powers
- Balkan Wars: without economic objectives, 31; and imperialism, 37
- Ballis, William, on doctrine of just war, 289
- Barker, Ernest, 477, 478, 486; on sovereignty, 261*n*
- Baron, Salo W., 478
- Barrère, Camille (French diplomatist), 106
- Barthou, Louis (French Foreign Minister), military alliance with Soviet Union, 373*n*
- Bartlett, Ruhl J., 8*n*, 29*n*
- Basel, Treaty of (1795), 184, 185
- Beales, A. C. F., 16*n*
- Beard, Charles A., 475, 476, 477, 488; on balance of power in American government, 128, 129; on imperialism, 29
- Beard, Mary R., 475
- Becker, Carl L., 475
- Belgium: German violation of neutrality in 1914, 189; neutrality guaranteed, 231. *See also* topical headings, especially Balance of power, World War, First, major powers
- Benedict, Ruth, 478
- Bentham, Jeremy, against colonies as cause of war, 16, 34, 309
- Bentwich, Norman, 482
- Berlin, Congress of: and balance of power, 141, 282; example of accommodating diplomacy, 444; and German prestige, 53
- Berlin, Treaty of (1878), 231
- Beveridge, Senator J., and imperialism, 29
- Bicocca, battle of (1522), example of limited warfare, 290
- Bismarck, Prince Otto von, 24, 37, 38, 45, 186, 189, 279; on Balkan Question, 282; on importance of Dardanelles for Russia, 385; and German power, 107; moral limitations of his foreign policy, 176, 177; on Russian national character, 97, 98
- Blackstone, Sir William, 350
- Bluff, policy of, 58, 59, 68; by Italy (1935-42), 58; by Great Britain (1797, 1940-41), 59
- Boer War (1899-1902), 279; economic causes, 31; and technology, 302
- Bolivia, invoking Article 19 of Covenant of the League of Nations against Chile, 355
- Bosanquet, Bernard, 481
- Bose, Subhas Chandra, 102
- Bowman, Isaiah, 478
- Boxer Rebellion (1900), 387
- Briand-Kellogg Pact (1928), 180, 211, 236; binding force, 218; and world public opinion, 197
- Brierly, J. L., 482, 486; on enforcement of international law, 228; on misconception of international law, 209; on reservations on jurisdiction of Permanent Court of International Justice, 222
- Briggs, Herbert W., 486
- Bright, John, 19
- Brinton, Crane, 487

## Index

- British Empire, based on prestige, 57; on self-restraint, 121. *See also* Great Britain, and topical headings
- British imperialism, *see* Imperialism
- Brodie, Bernard, 484
- Brogan, D. W., 478
- Brown, Francis J., 473
- Brunswick, Duke of (military commander in War of First Coalition, 1792-97), 185
- Bryce, James, 473; on balance of power in American government, 128, 129
- Bryson, Lyman, 475
- Buell, Raymond L., 473, 485
- Buffer states, 133
- Bukharin, Nikolai I., 476; on imperialism, 30, 46
- Bulgaria, peace treaty of 1947 with, 22
- Burke, Edmund, 96; on balance of power, 133, 148; on diplomacy, 440 ff.; on national power and self-restraint, 121, 122; on totalitarian propaganda, 301
- Burnham, James, and permanent character of power, 115*n*
- Burns, John (British statesman), 188
- Burns, C. Delisle, 474
- Burton, Margaret E., 486
- Caesar, Julius, 96; and imperialism, 28
- Calhoun, John C., on mission of the United States, 20
- Callières, François de, 488
- Cambon, Jules (French diplomatist), 106, 488
- Cambon, Paul (French diplomatist), 106, 154*n*
- Camden, William, 144*n*
- Canada, and naval disarmament, 315. *See also* topical headings
- Canning, George, and balance of power, 96, 140, 149, 367; and the Holy Alliance, 362 ff.; his influence on British power, 106; innovation in his policy, 367
- Cannon, Walter B., on analogy between biological and political equilibrium, 126*n*
- Capitalism, and imperialism, 29 ff.
- Carr, Edward Hallett, 475, 478, 481, 482, 483; on international morality, 177
- Carr-Saunders, A. M., 478
- Carthaginian Peace, and imperialism, 35; moral significance, 177
- Castlereagh, Viscount, 162; general character of his policy, 367; and the Holy Alliance, 362 ff.; influence on British power, 106
- Cato (Roman statesman), on Carthage, 177
- Cavour, and imperialism, 37; and Italian power, 107
- Cecil, Lord Robert (Elizabethan statesman), 184
- Cecil, Lord Robert (contemporary British statesman), on world public opinion, 197
- Chaco War, between Bolivia and Paraguay (1932-35), 236, 374; economic causes, 31
- Chadwick, H. Munro, 478
- Chamberlain, Joseph, and imperialism, 27, 28
- Chamberlain, Neville, dilemma in 1938: 114, 162; his influence on British power, 106, 107
- Chambrun, Charles de, 488
- Charlemagne, and unity of world, 309
- Charles II of England, and balance of power, 145
- Charles VIII of France, invasion of Italy, 89, 90
- Charles V of Hapsburg, and balance of power, 138, 144, 145, 156, 157; and imperialism, 157
- Chaumont, Treaty of (March 9, 1814), 361 ff.
- China, and balance of power, 273; civil war, 386, 387; civilization, 409; point of friction between United States and Soviet Union, 386, 387; policy toward, 23. *See also* Japan, topical headings
- Churchill, Winston, 53, 62, 89, 90*n*; on accommodating diplomacy, 445; on French Army in 1937, 113; and imperialism, 27, 28; influence on British power, 107; on British policy in Italo-Ethiopian War, 204, 337; on British population decrease, 94; on policy toward Soviet Union, 445
- Civilization: as social reactions to rules of conduct, 172
- Clarkson, Jesse, 484
- Clausewitz, Carl von, on war, 285
- Clemenceau, Georges, on German problem, 176, 177; and nationalism, 191; on importance of oil for national power, 84
- Coal, as element of national power, 84
- Cobban, Alfred, 478; on independence of small nations, 165*n*
- Cobden, Richard, on free trade as alternative to war, 16, 34
- Cochran, Thomas C., 484
- Colby, C. C., 478
- "Cold War," 285
- Collective security, 232 ff., 331 ff.; basic assumptions, 332 ff.; and balance of power, 142, 332 ff.; and Chaco War, 236; as defense of status quo, 332 ff.; and enforcement of international law, 232 ff.; ideal and reality, 332 ff.; as

- Collective Security (*continued*)  
 ideology, 64; and Italo-Ethiopian War, 236, 336, 337; under the League of Nations, 232 ff., 237, 332, 336, 337; and localized war, 334 ff.; and the national interest, 332 ff.; and peace, 334 ff.; political problem, 331 ff.; regional, 336n; and Russo-Finnish War (1939), 236; and the Sino-Japanese conflict (1931, 1937), 235, 236; and the status quo of Versailles, 318; and the United Nations, 236 ff.; as universal war, 334 ff.
- Collective self-defense, under Charter of the United Nations, 238, 239. *See also* United Nations Charter
- Colombia, and revolution establishing Panama (1903), 229
- Colonial expansion: influence upon balance of power, 278 ff.; of France, 278; of Great Britain, 278; of Spain, 278
- Colonies, claim for: ideological character of, 66n
- Communications, international, and international understanding, 201, 202
- Communist International, and imperialism, 41; and modern nationalism, 76; and nationalistic universalism, 194. *See also* Soviet Union, Totalitarianism, World War, Second
- Communists, policies in France during Second World War, 103
- Compensations, policy of: and colonial expansion, 135, 136, 279; at Congress of Vienna, 135; as method of balance of power, 135, 136, 151; standards of evaluation, 135. *See also* Diplomacy
- Competition, as refinement of struggle for power, 172, 173; as substitute for violence, 172, 173. *See also* Peaceful change, World community, World state
- Compromise, *see* Diplomacy
- Concert of Europe, 367, 368; and balance of power, 161, 162, 165; and colonial expansion, 368; and Crimean War, 368; as government by great powers, 367, 368; and moral consensus, 368; and nationalism, 368; success due to diplomacy, 368
- Conference on the Progressive Codification of International Law (1930), 215, 216
- Conscription in France (1793) and Prussia (1807, 1814), significance for nationalism, 291, 292
- Constitutional Convention of 1787, on sovereignty, 260, 261
- Convention for the Pacific Settlement of International Disputes (1899, 1907), 216, 225
- Convention with Respect to the Laws and Customs of War on Land (1864 and 1907), binding force after disregard in Second World War, 218, 219
- Conwell, Evans, 486
- Corbett, Percy E., 486
- Corwin, Edward S., 483
- Coups d'état, more likely than revolutions, 353. *See also* Revolution, State
- Crimean War (1854-56), and balance of power, 141, 158; and Concert of Europe, 368; and economic objectives, 31; and faulty diplomacy, 442
- Crucé, Emeric, 309
- Crusade, First, and imperialism, 32
- Crusades, and nationalistic universalism, 194, 195
- Cuba, *see* Havana, Treaty of
- Curti, Merle, 19n, 475
- Dardanelles, strategic importance, 385, 386. *See also* Bismarck, Turkey, topical headings
- Darwin, Charles, source of biological ideologies of imperialism, 65, 128
- Davis, Harriet E., 486
- Defoe, Daniel, on limited warfare, 288
- Delaisi, Francis, 476
- Dell, Robert, 486
- Democracy: influence on conduct of foreign affairs, 187, 188; and international morality, 187 ff.; and national morale, 104
- Denmark, national morale in Second World War, 104
- Descartes, René, 96
- Dewey, John, on German national character, 96
- Dicey, A. V., 482
- Dickinson, Edwin D., 482, 483
- Diderot, Denis, on war, 310
- Diplomacy, 105 ff., 419 ff.; ceremonial, 50 ff., 422; of "cold war," 285; and development of communications, 425, 426, 437; by compromise: 43, 44, 421, 430, 433, 441 ff., in disarmament, 323, financial incentives for, 323, made impossible by nationalistic universalism, 193; concept, 105n, 419; concomitant with modern state system, 426, 431; conditions of revival, 431 ff.; in conferences after Second World War, 428, 437; decline, 425 ff., 431 ff.; depreciation, 426, 427, 431; and espionage, 424; at Foreign Ministers' Conferences, 428; and fragmentation of international issues, 435 ff.; functions of foreign office: 421 ff., confused with representation, 437; instruments, 421 ff.; intellectual qualities, 273,

Diplomacy (*continued*)

279, 284, 430, 443; in fifteenth-century Italy, 424; of League of Nations, 427; legal representation, 423; legalism, 441, 442; by majority vote: 428, 433 ff., compared to majority vote in national societies, 434, 436; means, 421; in Middle Ages, 424; its militarization, 429, 430, 437, 438, 442, 443; and moral consensus, 440; and the national interest, 420, 421, 440, 443; as element of national power, 105 ff., 419; through negotiations, 136, 424, 428, 430, 432, 433, 443, 444; obsolescence between United States and Soviet Union, 428, 430; open, 427, 428, 431 ff.; at Paris Peace Conference of 1946, 428; by parliamentary procedures, 427, 428, 431 ff.; and peace, 419 ff., 430, 433, 435, 437 ff.; through persuasion, 421, 424, 443, 444; political representation, 423, 424; inseparable from power politics, 426, 431; through pressure, 155, 443, 444; and propaganda, 424, 433, 437; and the pressure of public opinion, 432, 433; secret, 426, 427, 431 ff.; as source of information, 423, 424, 430; as symbolic representation, 52, 422; its tasks, 419 ff., 438 ff.; through threat of force, 421, 424, 430; of United Nations, 427, 428, 437; and World community, 444, 445; and World state, 419, 445

"Diplomacy by conference," 162, 362

Diplomacy, quality of: Belgium, 106; importance of its constancy, 107, 108; France, 106, 107; Germany, 106 ff.; Great Britain, 106 ff.; Italy, 107; Rumania, 106; Franklin D. Roosevelt, 429; Soviet Union, 422, 429, 430; United States, 105 ff., 428 ff. *See also* major powers

"Diplomatic revolution" of 1756, 274

Disarmament, 311 ff.; in aggressive weapons, 328; in atomic weapons, 319 ff., 324, 327, 328; standards of allocation, 321 ff.; difficulties of allocation, 136, 137, 322 ff.; as method of balance of power, 136, 137, 314, 315, 330; and character of war, 327 ff.; concepts, 311; general, 311, 317 ff.; at Hague Peace Conferences, 312, 317; history, 311 ff.; local, 311, 315, 317; basic misconception, 327; and peace, 326 ff.; dependent on settlement of underlying power conflict, 315, 318 ff., 322 ff., 327 ff., 331; main problems, 314 ff.; qualitative, 311, 328, 329; quantitative, 311, 329; and the ratio of armaments, 314 ff.; as regulated armaments race, 315, 317, 324 ff., 329; Russian proposals for universal, 327; and

Disarmament (*continued*)

security, 317 ff.; in Treaty of Versailles, 312, 329. *See also* Armaments, individual agreements and conferences

Disraeli, and accommodating diplomacy, 444; and imperialism, 27, 28

"Divide and rule," as method of balance of power, 134, 135, 143

Dolivet, Louis, 486

Dollar diplomacy, 97

Dollar imperialism, 39

Donnadieu, Léonce, 480

Dred Scott Case, 353

Duguit, Léon, 483

Dulles, Allen W., on plot against Hitler, 301*n*

Dunn, Frederick S., 475, 477, 486; on Article 19 of Covenant of League of Nations, 355

Dupuis, Charles, 480

Eagleton, Clyde, 486

Earle, Edward Mead, 89*n*, 484

Economic policies, bearing on power, 15, 32, 33, 38, 48

Egypt, sovereignty, 252*n*

Einzig, Paul, 476

Elizabeth of England, and balance of power, 144

Embargo, moral, against Japan (1938) and Soviet Union (1939), 182

Emeny, Brooks, 474, 477, 478

Enlightenment, and peace, 310

Equality, in armaments, 65, 316 ff., 321 ff.; as synonym of sovereignty, 246

Equilibrium, concept of: in economics, 126; in human body, 126. *See also* Balance of power

Erasmus, 309

Ethics, concept, 170; as restraint on struggle for power, 170 ff. *See also* Morality, Rules of conduct

Ethiopia, competition for domination, 135, 136. *See also* Italo-Ethiopian War, topical headings

Europe, United, and balance of power, 275, 278; opposition of Soviet Union, 134. *See also* topical headings

Evatt, Herbert V., 486

Ewing, Alfred C., 487

Expediency: and morality in international affairs, 174 ff.

Fairgrieve, James, 478; on geopolitics, 118; on modern technology, 302, 303

*Federalist, The*: on balance of power, 127 ff.; on international conflicts, 440; on sovereignty, 261

## Index

- Fénelon, on balance of power, 160, 161, 285, 286, 438; and international morality, 195; on total war, 288
- Ferrero, Guglielmo, 211, 476, 482, 484
- Fichte, Johann Gottlob, on nationalism, 118, 119
- Fifth column, and imperialism, 41. *See also* Communist International, Communists, National Socialism
- Finer, Herman, 488
- Finkelstein, Louis, 475
- Finland, *see* Russo-Finnish War (1939), topical headings
- Fischer, Eric, 484
- Foch, Ferdinand, on limited and total war, 288, 289
- Foner, Philip S., 331
- Food and Agriculture Organization, 412; majority rule, 257
- Force, as instrument of foreign policy, 443. *See also* Diplomacy, Foreign policy, Military policy, Power, War
- Foreign policy, as estimate of power relations, 56, 152 ff.; and military policy, 55. *See also* Diplomacy, International politics
- Foster, John W., 488
- Four Freedoms, 97
- Fourteen Points of Woodrow Wilson: and open diplomacy, 427; and world public opinion, 202, 203
- Fox, William T. R., 484
- France: and balance of power, 144, 274 ff.; policy of "divide and rule" toward Germany, 134; failure of policies between World Wars, 376, 377; hegemony after First World War, 35, 134, 371 ff.; policy in Italo-Ethiopian War, 336, 377; and League of Nations, 370 ff.; policies after First World War, 317 ff., 323; Rhine frontier as objective, 14, 82. *See also* topical headings
- Francis I of France, and balance of power, 138, 144, 145
- Francis II of Austria, 186
- Franco-Prussian War (1870), 45, 177, 442; and imperialism, 31; and technology, 301, 302
- Franklin, Benjamin, diplomacy of, 107
- Frederick the Great, 76, 147, 151, 185; contempt for artillery, 294; and localized imperialism, 37, 157; and mercenaries, 290; his military genius as element of national power, 90; on uncertainty of balance of power, 152, 153
- Free trade, as alternative to war, 16, 34
- Freeman, Harrop A., 486, 488
- French Revolution of 1789, and nationalism, 189, 310
- Friedensburg, Ferdinand, 479; on natural resources, 841
- Friedman, W., 478
- Friedrich, Carl J., 480, 486, 488
- Fuller, J. F. C., 71
- Furness, J. W., 479
- Gaulle, Charles de, on balance of power, 274, 275
- General Act for the Pacific Settlement of International Disputes (1928), 216
- Geneva Convention on prisoners of war, 179
- Geneva Naval Conference (1927), 314
- Genoa, competition with Venice, 52
- Genocide, *see* Mass extermination
- Geography, as element of national power, 80 ff., 109 ff., 151; and geopolitics, 110 ff.; Great Britain, 80, 81; Italy, 81; Soviet Union, 81, 82, 109, 110; Spain, 81; United States, 19, 80, 109
- Geopolitics, 116 ff.
- George V of England, 141
- Germany: Bismarck, William II, and Hitler representing different types of imperialism, 37, 176; competition for its domination after Second World War, 130; moral significance of German problem, 176, 177; policies: 1870-1914: 45, 46, on eve of First World War, 156, 282, 442, after First World War, 35, 36, 142, 317 ff., 323, 329; policy toward, after First World War, 177, 371; traditional French policy toward, 135; provisional status after Second World War, 384; foreign policy determined by lack of self-sufficiency in food, 82, 83; unification, 270, 289. *See also* National Socialism and topical headings
- Gerth, H. H., 475
- Gibbon, Edward, on balance of power, 160, 163, 195; on ideologies of imperialism, 64, 65; on universalistic principles of morality, 1951
- Gilbert, Felix, 891
- Gini, Corrado, 479
- Goethe, Johann Wolfgang, 76
- Gooch, G. P., 478; on nationalism, 189
- Good Neighbor Policy, 57, 58. *See also* United States
- Goodrich, Leland M., 1971, 3791, 486
- Government: influence of its quality on national power, 104, 152, 175, 176
- Grant, A. J., 480
- Granville, Cardinal de, 1441
- Gray, John Chipman, on literature of international law, 174
- Great Britain: anti-militarism, 99; and balance of power, 5, 6, 143 ff., 273 ff.,

## Index

### Great Britain (*continued*)

- 367, 371, 372, 376; decline in power, 273, 274; and disarmament, 311, 315 ff., 329; failure of policies between World Wars, 376, 377; policy toward Greece, 386; policy in Italo-Ethiopian War, 336, 337; and League of Nations, 370 ff.; and Palestine, 356 ff.; policies before First World War, 141, 142, 153, 154, 156, 335; policies toward Germany before Second World War, 316, 317; policies after Second World War, 107; retreat from Asia, 22*n*, 31, 107; policies toward Russia in nineteenth century, 444; policies determined by lack of self-sufficiency in food, 82, 83; sovereignty of dominions, 252*n*; sources of power, 14; objectives of trade policies, 48; policy toward Turkey, 385. *See also* British Empire, topical headings
- Greece: civil war, 386; importance in First World War, 272; point of friction between United States and Soviet Union, 385, 386. *See also* major powers and topical headings
- Grey, Sir Edward (British Foreign Secretary), 154*n*, 162; and the Concert of Europe, 368
- Griswold, A. Whitney, 485
- Gross, Leo, 476
- Grotius, Hugo, 309; on diplomacy, 424; and early international law, 210; on war against noncombatants, 178, 179
- Guaranty, treaties of: and balance of power, 231; and enforcement of international law, 230 ff.
- Guerard, Albert, 487
- Guicciardini, on balance of power, 138
- Gulick, Edward V., 480
- Gurian, Waldemar, 474
- Gyorgy, Andrew, 479
- Hague Conventions on rules of war, 178, 179. *See also* Convention
- Hague Peace Conferences (1899, 1907), 180, 309; and disarmament, 312, 317. *See also* topical headings
- Hambro, Edvard, 197*n*, 379*n*, 486
- Hamilton, Alexander: on balance of power in American government, 129; on sovereignty, 260, 261
- Hamlet, on prestige, 346
- Handman, Max, 476
- Hankey, Lord Maurice P., 486
- Hardenberg, Count von (Prussian statesman), 185
- Harley, John E., 474, 486
- Hart, Albert Bushnell, 427*n*
- Hart, B. H. Liddell, 484
- Hart, Hornell, on modern technology, 303
- Hartshorne, Richard, 479
- Hashagen, Justus, 476
- Haushofer, Karl, on geopolitics, 118
- Havana, Treaty of, between United States and Cuba (1901), 251, 252
- Hayes, Carleton J., 478
- Heatley, David P., 474, 488
- Hegel, Georg Wilhelm Friedrich, 96; on nationalism, 118, 119
- Hemleben, Sylvester J., 485
- Henry II of France, on balance of power, 114
- Henry VIII of England, 5, 107; and balance of power, 138, 144
- Hertz, Frederick, 478
- Hilferding, Rudolf, on imperialism, 29
- Hill, Chesney, 474
- Hirohito, and imperialistic war, 156
- Hirschman, Albert O., 479
- Hitler, Adolf, 5, 6, 96, 100, 101, 107, 156, 157, 271; depreciation of American power, 59; and Austrian independence, 148; and German power, 107, 108; and imperialism, 32, 36, 37, 42, 47, 67, 68, 81; and mass extermination, 176, 177; and national morale of conquered peoples, 102, 103; plot against (1944), 300*n*. *See also* National Socialism
- Hobbes, Thomas: on compulsory adjudication, 221; conception of politics, 169; and sovereignty, 261; on contribution of state to peace, 391, 397; on unlimited desire for power, 36*n*
- Hobson, John A., 476; on imperialism, 30
- Hodges, Charles, 473, 474
- Hoijer, Olaf, 480
- Holmes, Oliver Wendell, on sovereignty, 250*n*
- Holy Alliance, 361 ff.; ambassadorial conferences, 363; and Austria, 364 ff.; and balance of power, 161, 162, 165; British conception of status quo, 364 ff.; and France, 362, 364, 365; as government by the great powers, 363; and Greek revolt against Turkey (1821), 365, 366; ideological function, 64, 362, 365, 366; and imperialism, 157; and intervention, 362 ff.; conception of justice, 362, 363, 366, 367; legal basis, 361, 362; and liberalism, 366, 367; and moral unity of Europe, 362; and the national interest, 364 ff.; and nationalism, 366, 367; and nationalistic universalism, 193, 194; and peace, 309, 365 ff.; principles, 161, 162, 189, 361 ff.; Russian conception of status quo, 364 ff.; and small powers, 363; and the status quo, 23,

## Index

- Holy Alliance (*continued*)  
363, 364, 366; Treaty of the (September 26, 1815), 361 ff.
- Holy Roman Empire, and unity of the World, 309
- Hovde, Brynjolf J., 476
- Huber, Max, 482
- Huizinga, J. H., 481
- Hula, Erich, 478; on Nuremberg trials, 218<sup>n</sup>
- Hull, Cordell, 16; moral condemnation of air bombardment of civilians, 182; on world public opinion, 197
- Hume, David, 480
- Huszar, George B. de, 488
- Huxley, Julian, 488
- Hyde, Charles C., 213
- Ideologies, in foreign affairs, 49, 157 ff., 174, 180, 262, 263, 318, 343 ff., 378; nature of political, 61 ff., 169, 261 ff., 344 ff. *See also* Balance of power, Holy Alliance, Imperialism, International law, League of Nations, National self-determination, Peace, Power, Regional arrangements, Sovereignty, Status quo, United Nations
- Imagination, creative, needed in international affairs, 116
- Immigration: influence upon distribution of power, 92; as stumbling-block to world state, 402
- Imperialism, 22<sup>n</sup>, 130 ff., 156 ff., 320, 321, 339, 342 ff.; advantage over policy of status quo, 156, 157; American, 28, 29, 36, 37, 39; Arab, 32, 36, 65; British, 22<sup>n</sup>, 27 ff., 39; as colonial expansion, 26<sup>n</sup>, 29, 31, 36, 65; continental, 36, 37; cultural, 38, 40 ff., 47, 48; difficulties of detection, 46 ff., 66 ff., 420; economic, 38 ff., 47, 48; economic theories of, 29 ff.; French, 39, 42; German, 35, 36, 38, 39, 41, 44, 45, 47, 57, 66, 67, 157; ideological, 40<sup>n</sup>; not identical with any increase in power, 27; ideologies of, 49, 63 ff., 318; Japanese, 39, 65, 66, 157; localized, 36 ff.; Macedonian, 48, 411; methods, 38 ff.; military, 38, 39, 42; moral restraints upon, 38; polemic use of term, 26, 27, 62, 66, 67; not identical with preservation of empire, 27; as reaction to lost war, 35, 36, 65, 318, 319; retreat of, 31; Roman, 28, 31, 35, 36, 39; Russian, 37, 39 ff., 65; and stimulation of population growth, 92; Swedish, 48; totalitarian methods of, 41, 42; types, 34 ff., 48, 49; unlimited, 36; growing from victory in war, 34, 35, 157; weakness as inducement to, 36, 65, 67
- Independence, as synonym of sovereignty, 245, 246
- India: and balance of power, 273; and British imperialism, 42; British retreat from, 107; political weakness due to lack of industrial capacity, 87
- Industrial capacity, as element of national power, 86 ff., 109, 110, 181, 182; France, 87, 88; Germany, 87, 88, 109; Great Britain, 87; India, 87; Soviet Union, 88; United States, 88, 109
- Industrial Revolution, *see* Technology
- International Bank for Reconstruction and Development, and unequal representation, 257, 412
- International Civil Aviation Organization, 412; and majority rule, 257
- International conflicts: general nature, 435, 436; types, 343 ff.; UNESCO'S conception, 410, 411. *See also* International courts, Political disputes, Tensions
- International Court of Justice, 211, 216, 224 ff.; contribution to international law, 226; and interpretation of international law, 217<sup>n</sup>; optional clause, 221 ff.; Statute: Article 3: 225, 226, Articles 4-6, 8-12, 19, 31: 226, Article 36: 221 ff., Article 59: 226, 227. *See also* International courts, Permanent Court of International Justice
- International courts, 219 ff.; absence of hierarchical organization, 227, 228; concept of adjudication, 220<sup>n</sup>; Austro-German Customs Union Case, 224; and social change, 350; compliance with decisions, 230; *compromis*, 221; compulsory jurisdiction: 220 ff., accepted only between nations without political conflicts, 347; and defense of status quo, 318, 342 ff.; decline, 354; mistaken analogy with domestic courts, 342 ff., 349; reservation of domestic jurisdiction, 223, 247, 248, 382<sup>n</sup>; decisions according to equity, 354; decisions *ex aequo et bono*, 354; limitation of functions, 343 ff., 354; dependent upon moral consensus, 354; organization, 224 ff.; and peace, 341 ff.; reservations limiting compulsory jurisdiction, 221 ff.; as restraint on struggle for power, 224, 258; and *stare decisis*, 220, 227, 228. *See also* Arbitration, International Court of Justice, Permanent Court of Arbitration, Permanent Court of International Justice
- International Danube Commission, and sovereignty, 254, 257
- International Government, and peace, 361
- International Institute of Agriculture, 211; and unequal representation, 257



## Index

- International Labor Organization, 215, 412
- International law, 209 ff.; binding force, 217 ff., 244, 245; codification, 214 ff.; compliance with, 211, 227, 230; consent as source, 212, 244, 245; decentralized character, 211 ff., 217, 218, 224 ff., 228 ff., 232 ff., 237 ff., 243 ff.; enforcement, 211, 228 ff., 245; dependent on political considerations, 229; history, 209 ff.; as ideology of status quo, 63 ff., 342 ff.; interpretation, 216, 217; judicial function, 219 ff., 245; legislative function, 211 ff., 244; no legislative bodies for peaceful change, 354; of the maritime belt, 213, 214; misconceptions, 209 ff., 244; and modern state system, 209, 210; different national conceptions, 213; and the national interest, 214 ff., 229, 230, 240, 241; general nature, 209 ff., 245, 246; necessity as source, 212, 244; of the Nuremberg trials, 218; as protection of sovereignty, 267, 268; and primitive law, 211; reservations and binding force, 244, 245; sources, 212, 213, 244, 245; static character of, 64, 65; relation to status quo, 342 ff.; treaties as source, 212, 213; effect of treaties on third parties, 212; and world public opinion, 197. *See also* International conflicts, International courts, International organization, Sovereignty
- International Monetary Fund, 211, 412; and unequal representation, 257
- International organization: majority rule, 256 ff.; unequal representation, 256, 257; voting strength and actual distribution of power, 369, 370, 375, 435. *See also* International law, League of Nations, Majority vote, United Nations, and other organizations
- International police force, 337 ff.; and American public opinion, 262, 263; mistaken analogy with national police, 337 ff.; as defense of status quo, 338 ff.
- International politics: different approaches to, 3, 4; three patterns of, 21; peculiarities of science of, 4 ff.; in eighteenth century, 273; 1870-1914, 279; contemporary: military character of European status quo, 384, 385; provisional character of status quo, 384, 385. *See also* Balance of power, Concert of Europe, Diplomacy, Foreign policy, Holy Alliance, Imperialism, League of Nations, United Nations, major powers
- International Red Cross, 211
- International Telecommunication Conferences, and unequal representation, 257
- International Telecommunication Union, 412, 414
- International Trade Organization, 412
- Intervention, prohibition of, as duty to respect independence, 246; of United States and Great Britain in Eastern European countries, 246; of League of Nations against Austro-German Customs Union, 246
- Iran: Anglo-Russian agreement of 1947, 386; point of friction between United States and Soviet Union, 386; and Russo-British imperialism, 39, 40, 130, 136, 386. *See also* major powers
- Ireland, and British imperialism, 42
- Isolationism: as British foreign policy, 145; as geopolitics, 118*n*; United States, 19, 20
- Italo-Ethiopian War (1935-36), 236. *See also* Collective security, League of Nations, World public opinion, major powers
- Italo-Turkish War (1911-12), 279; and economic objectives, 31
- Italy: and balance of power before First World War, 144; foreign policy, 142, 153; importance in First World War, 272; and League of Nations, 377; peace treaty of 1947 with, 22, 384; unification, 270, 289. *See also* topical headings
- James, William, 96, 488
- Janowsky, Oscar I., 478
- Japan: invasions of China (1931, 1937), 387; and naval disarmament, 314, 316. *See also* other topical headings
- Jefferson, Thomas, diplomacy of, 107
- Jay, John, diplomacy of, 107
- Jessup, Philip C., 482, 485
- Jones, Joseph M., 489
- Judicial function, *see* International conflicts, International courts, International law, Peaceful change, Political disputes.
- Jusserand, Jean A., 489
- Justice, *see* Holy Alliance, League of Nations, Peace, Peaceful change, United Nations, World community, World state
- Kaebler, E., 480
- Kahler, Alfred, 484
- Kalijarvi, Thorsten V., 474
- Kant, Immanuel, 96; on war, 309, 310
- Kaunitz, Prince von (Austrian Chancellor), 184
- Kautilya (Indian political philosopher), 480
- Kautsky, Karl, on imperialism, 29
- Keeton, George W., 482, 483; on codification of international law, 216

## Index

- Kelsen, Hans, 212*n*, 483, 486  
Keynes, John Maynard, on nationalism, 191  
Kipling, Rudyard, and imperialism, 28  
Kirk, Dudley, 479; on Russian losses in Second World War, 294*n*  
Kirk, Grayson, 474; on science of international politics, 3  
Kohn, Hans, 478  
Koo, Wellington, Jr., 483  
Krabbe, H., 483  
Kraus, Heibert, 481
- Lange, Christian, 485  
Langer, William L., 476, 480  
Laski, Harold J., 478, 483  
Lasswell, Harold D., 475, 476, 482  
Latin America, and balance of power, 139, 140, 147, 149, 159, 273. *See also* United States, topical headings  
Laupen, battle of (1339), 89  
Lauterpacht, H., 482, 486; on jurisdiction of international courts, 221, 222; on majority vote in United Nations General Assembly, 258. *See also* Oppenheim-Lauterpacht  
Laval, Pierre, 189  
Law, Narendra, 480  
Law, concept, 170; as restraint on struggle for power, 170 ff. *See also* International law, Peaceful change, World state  
League of Nations, 232 ff., 368 ff.; and the Aaland Islands, 377; and balance of power, 142, 165, 191; British conception, 371, 372; Chaco War, 374; as clearing-house, 372; and codification of international law, 215, 216; as government of Danzig, 373, 374; and distribution of power, 375 ff.; as enforcement agency, 371, 372; and fragmentation of international issues, 436; French conception, 371, 372; and Germany, 377; and German violations of Treaty of Versailles, 374; as government by great powers, 369, 370, 373, 378; successor to Holy Alliance, 367, 368; principles transformed into ideologies, 378; and Italian occupation of Corfu (1923), 374; and Italo-Ethiopian War (1935-36), 370, 374; and Japanese invasion of China (1931, 1937), 374, 378; principles of justice, 371, 372, 377, 378; legalism in settling international issues, 436; majority vote, 355, 356; and mandated territories, 373; and the national interest, 370 ff., 377, 378; organization, 369, 370; and peace, 16, 309, 341, 374 ff.; and peace treaties of 1919, 371; and Polish seizure of Vilna (1920), 374; as govern-
- League of Nations (*continued*)  
ment of Saar Basin, 373; and Soviet Union, 374 ff., 436; and Spanish Civil War, 370, 374, 378; and the status quo, 23, 64, 371 ff., 378; predominantly European structure, 375; principle of unanimity, 355, 369, 378; predicated upon unity of great powers, 378; lack of universality, 375 ff.; and the partition of Upper Silesia, 377; veto, 378; and war, 180, 374; weaknesses, 373; and world public opinion, 197  
League of Nations Assembly, 235, 236, 355, 356, 369, 370, 379; influence of small nations, 370  
League of Nations Council, 234, 235, 369, 379; as organ of status quo, 347  
League of Nations Covenant, 211, 216, 217, 219; preamble, 371, 374; Article 3: 370*n*; Article 8: 312; Article 10: 23, 371; Article 11: 371; Article 12: 233, 234, 371, 374; Article 13: 233, 234, 371, 374; Article 14: 347, 371; Article 15: 233, 234, 247, 248, 369, 370*n*, 371, 374, 380; Article 16: 232 ff., 238, 371; Article 17: 375; Article 19: 354 ff., 360, 371; Article 22: 373*n*  
Lee, Muna, 488  
Legitimacy, principle of, 161. *See also* Holy Alliance  
Leith, C. K., 479  
Lenin, on imperialism, 29, 30  
Leopold I and II of Belgium, 106  
Lewis, Cleona, 479  
Lewis, Edward R., 487  
Liberalism: and imperialism, 29, 30; and peace, 310; conception of state, 395. *See also* Holy Alliance, Power  
Lindsay, A. V., 481  
Lippmann, Walter, 482, 484, 489; on world public opinion, 202, 203  
Lloyd, Georgia, 485  
Locarno Pact (1925), 23, 24, 231, 372  
Locke, John, 96, 170  
London Naval Conference and Treaty (1930), 314, 325  
London Naval Conference (1935-36), 314  
London Protocol concerning submarine warfare (1936), 179  
Long, Huey, on fascism in United States, 66  
Louis XIV of France: and balance of power, 138, 144, 145, 151, 376; and continental imperialism, 37, 38, 157  
Louis XV of France, 186, 187; and localized imperialism, 37  
Love, Alfred, 19  
Lowell, A. Lawrence, 482

## Index

- Luxembourg, neutrality guaranteed, 231  
 Luxembourg, Rosa, on imperialism, 307
- Mably, Abbé de, 489
- Macedonian Empire, geographical limits, 298. *See also* Imperialism, World empire
- Machiavelli: conception of politics, 169; on limited war, 287, 288; on revolution in warfare, 89
- Machine gun, revolution in warfare, 296, 297
- MacIver, R. M., 475
- Mackinder, Sir Halford J., 479; on geopolitics, 116 ff.
- McCallum, R. B., 487
- McMurry, Ruth E., 488
- Madariaga, Salvador, 479
- Madison, James, on balance of power in American government, 129; diplomacy of, 107; on sovereignty, 260, 261
- Mahan, Alfred Thayer, and militarism, 120
- Majority vote, irrelevant in political issues, 356. *See also* International organization, League of Nations, United Nations
- Mander, Linden A., 474
- Mannheim, Karl, 475, 477; on concept of ideology, 617
- Marck, Siegfried, 476
- Maria Theresa, and localized imperialism, 37
- Marriott, J. A. R., 485, 487
- Marshall plan, 101
- Martin, Charles E., on science of international politics, 3
- Martin, William, 487
- Marx, Karl, 16
- Marxism: and imperialism, 29; and nationalistic universalism, 194; conception of state, 395
- Mass extermination, as moral problem of international politics, 176, 177
- Mattern, Johannes, 479, 483
- Maxwell, Bertram W., 474
- Mazarin, and French power, 107
- Merriam, Charles E., 475, 483; on sovereignty, 2617
- Metternich, Prince, 52; on diplomacy, 426; and the Holy Alliance, 362, 366
- Mexican War (1846-48), 7, 8
- Meyer, Cord, 487
- Middlebush, Frederick A., 474
- Militarism, as mistaken evaluation of national power, 120 ff.; in Germany, 120, 121; in Great Britain, 120; in Japan, 121; in Soviet Union, 120; in Sparta, 121; in United States, 120; used as reproach by naval powers, 120
- Military establishment, quantitative and
- Military establishment (*continued*)  
 qualitative composition as element of national power, 90, 91, 110
- Military force, display of, and policy of prestige, 54, 55
- Military leadership, as element of national power, 90
- Military policy, relation to foreign policy, 55. *See also* Diplomacy, Force, Power, War
- Military power, fascination of, 115, 116
- Military preparedness, as element of national power, 88 ff.
- Mill, John Stuart: on balance of power in domestic politics, 1287, 163; on creation of governments, 399, 400
- Millar, Moorhouse, F. X., on Nuremberg trials, 2187
- Mills, C. Wright, 475
- Minorities Treaties, 216, 248
- Mitrany, David, 485, 488; on functional approach to world community, 413
- Mobilization, as policy of prestige, 55
- Money, as instrument and symbol of power, 173
- Monroe Doctrine, 5, 6, 24, 25, 37, 108; and balance of power, 139, 140; Roosevelt Corollary to, 8
- Moon, Parker T., 474, 476; on imperialism, 267
- Moore, John Bassett, 482
- Moral consensus, *see* Balance of power, Diplomacy, Holy Alliance, International courts, Morality, World state, World community
- Moral limitations on international politics, concerning human life in peace, 175 ff., human life in war, 178 ff., through financial interests, 184, 185
- Morality in international affairs, 161 ff., 169 ff., 174 ff.; of aristocracy, 184 ff.; decline in our time, 181 ff., 187 ff., 267 ff., 333, 354; misconceptions, 174, 175; of nationalism, 170 ff., 267; its reality, 174, 175
- Mores, concept, 170; as restraint on struggle for power, 170 ff., 267. *See also* Rules of conduct
- Morgan, Laura P., 485
- Morgarten, battle of (1315), 89
- Morgenthau, Hans J., 337, 475, 481, 482, 486, 487
- Morley, Felix, 487
- Morley, John Viscount, 167, 188, 489
- Moscow Conference (1943), 16
- Moscow, Foreign Ministers' Conference at (1947), 159
- Motivation in international politics, 227
- Mowat, R. B., 474

## Index

- Mowrer, Paul S., 489  
Mumford, Lewis, 484  
Murphy, Gardner, 488  
Mussolini, 176; and imperialism, 37, 68; concept of politics, 170; and policy of prestige, 56
- Napoleon I, 5, 6, 51, 52, 90, 259, 299; on value of artillery, 294; and imperialism, 32, 36, 39, 42, 48, 65, 81, 157; and balance of power, 134; and national morale of conquered peoples, 102; and nationalistic universalism, 193, 194; and unity of the world, 309
- Napoleon III, and balance of power, 134; and continental imperialism, 37; diplomacy on eve of Franco-German War of 1870, 442; and disarmament, 311, 312
- Napoleonic Empire, causes of downfall, 299, 300, 403; geographical limits, 298
- Napoleonic Wars, and balance of power, 138, 158, 161, 162, 164, 165, 270, 310, 364, 376; and modern nationalism, 76, 77, 289; and problem of peace, 310; and total war, 289, 291
- Nation, concept, 73, 74, 118
- National character, as element of national power, 96 ff., 120, 152; and nationalism, 118 ff.; and racism, 119, 120; France, 96, 101; Germany, 96, 98 ff., 409; Great Britain, 96, 98 ff., 110; Russia, 97 ff.; United States, 97 ff., 120
- National interest, as national security, 440. *See also* Diplomacy, Holy Alliance, International law, League of Nations, Peace, United Nations
- National morale, as element of national power, 100 ff., 152; and foreign conquest, 102, 403; dependence upon quality of government, 104; influence upon foreign policy, 104; influence of internal dissensions and injustices upon, 102 ff.; of France in First World War, 101, in Second World War, 103, 104; of Germany in two World Wars, 101 ff.; of Italy in First World War, 101; in Latin-American countries, 104; of Portugal, 104; of Russia in First World War, 101, 102; of Soviet Union in Second World War, 102, 103; of Spain, 104; of United States, 101
- National power, 74 ff., 80 ff.; consummation in self-restraint, 121, 122; equated with material force, 121; instability, 114 ff.; relativity, 110 ff.; of Germany, 111; of Great Britain; 111, from Napoleonic Wars to First World War, 113, 114, decline after First World War, 114, reasons for its permanence, 121. *See*
- National power (*continued*)  
*also* different elements, such as Geography, Natural resources, Territory, etc.
- National power, evaluation of, 56, 109 ff., 420, 423, 424; errors in: of Germany, 99, 100, 115, of France, 112 ff., of Great Britain, 100, of Soviet Union, 99, 114, 115, of United States, 100; typical errors in, 112 ff.; of France and Germany between two World Wars, 112, 113; as series of hunches, 111, 112, 151, 152, 322 ff.; need for creative imagination, 116; of United States and Soviet Union, 110, 111
- National self-determination, 165, 268, 368, 371, 372, 377, 378, 383; as ideology, 67, 191
- National Socialism, fifth column, 41; and geopolitics, 118; ideologies, 65; international objectives, 13, 35, 36, 47; as prototype of pseudo-religious nationalism, 77, 78; nationalistic universalism, 194. *See also* Hitler, Mass extermination, Totalitarianism
- Nationalism, 74 ff., 118 ff., 262, 267 ff., 393, 394, 414; two kinds of conflicts growing from, 269; and conscription, 291, 292; destructive influence on international morality, 189 ff.; and French Revolution, 189, 310; and mass insecurity, 76 ff.; and middle classes, 75 ff.; as mistaken evaluation of national power, 118 ff.; morality of, 190 ff., 267 ff., 395, 393, 394, 414; religion identified with, 190, 191; as secular religion, 77, 119, 268, 305, 396, 438 ff.; and total war, 289; in Germany, 77 ff., 118, 119; in Soviet Union, 78, 79; in United States, 79. *See also* Morality, Nationalistic universalism
- Nationalistic universalism, 192 ff., 267 ff., 430, 438 ff.; distinct from traditional nationalism, 193, 194, 268, 269, 292; and total war, 289; and tribalism, 195, 196. *See also* Morality, Nationalism
- Natural law, as ideology of imperialism, 65
- Natural resources, as element of national power, 82 ff. *See also* Coal, Oil, and major powers
- Näf, Werner, 487
- Näg, Kalidas, 480
- Near East, political decline and decline of agriculture, 83; political importance derived from oil, 84, 86
- Nearing, Scott, 476
- Nef, John U., 288n; on total war, 305n
- Nec-Holy Alliance (1820), 362 ff.; principles, 362, 364 ff.; and the status quo, 364. *See also* Holy Alliance

- Nickerson, Hoffman, 484  
 Nicolson, Harold, 477, 487, 489  
 Niebuhr, Reinhold, 481, 487  
 Nietzsche, Friedrich, concept of politics, 170  
 Nine Power Treaty (1922), 23, 236  
 Noel-Baker, Philip, 16  
 North, Lord, his influence on British power, 106  
 North Africa, political decline and decline of agriculture, 83  
 Notestein, F. W., 479  
 Nuremberg trials, 218  
 Nye Committee, on origins of First World War, 30  
 Nys, Ernest, 480, 487
- Ogburn, William F., 484  
 Ogg, F. A., 322  
 Oil, as element of national power, 84, 86  
 Oil diplomacy, as imperialism, 39, 86  
 Oman, Sir Charles, 484; on limited warfare, 287*n*  
 Oncken, Hermann, 489  
 "One World," ambiguity of concept, 200 ff.  
 Open Door, policy toward China, 387.  
*See also* China, United States  
 Oppenheim-Lauterpacht, 213*n*, 214*n*; on treaties of guaranty, 231; on number of decisions of Permanent Court of International Justice, 347*n*; on sanctions in Italo-Ethiopian War, 236  
 Oppenheim, L., 487  
 Orwell, George, on Burnham, 115*n*
- Padover, S. K., 481  
 Paléologue, Maurice (French diplomatist), 106  
 Palestine, *see* Peaceful change, United States  
 Palmerston, Viscount, 115; his foreign policy, 367  
 Paris, Convention of (April 23, 1814), and balance of power, 138; declaration of, concerning maritime warfare (1856), 179; Treaty of (1815), 23; Treaty of (1856), 231  
 Parsons, Elsie C., 475  
 Parsons, Talcott, 475  
 Paullin, Theodore, 485, 486, 488  
 Pavia, battle of (1525), example of limited warfare, 290  
 Peace, and the common good, 361; not result of specific device, 361; as ideology, 63, 64; indivisibility, 335; and justice, 361, 392, 394, 395; conditions for, in national societies, 392 ff.; and peaceful change, 395; and power, 392, 395 ff.
- Peace (*continued*)  
 dependent on pluralism of loyalties, 392, 393; problem of, attempts at its solution, 309, 310, 443, 444; dependent on integrated society, 444; dependent on suprasedational loyalty, 392 ff.; contribution of state to, 391, 396 ff.; and world state, 391  
 Peaceful change, 64, 350*n*, 395, 396; not achieved by any particular agency, 351; and American Civil War, 396; mistaken analogy between national and international, 353, 354; conditions for, 350 ff.; and the courts, 350 ff.; a dictatorship, 352; dilemma in international society, 355, 356, 358, 360; and domestic peace, 395; and the executive power, 350 ff.; in free societies, 350 ff.; in Great Britain, 350, 396; in League of Nations, 354 ff.; and the legislature, 350 ff., and the national interest, 355, 356, 358 ff.; in national societies, 64, 350 ff.; and Palestine resolution of General Assembly of the United Nations, 356 ff.; through public opinion, 350 ff.; and the power of the state, 351; in United Nations, 354, 356 ff., 396; and the United Nations Security Council, 434 in United States, 350 ff.  
 Pearl Harbor, and lack of American prestige, 59  
 Peel, Sir Robert, 297  
 Pelcovits, N. A., 488  
 Penn, William, 309  
 Permanent Court of Arbitration, 225; non-political character of decisions, 347. *See also* International courts  
 Permanent Court of International Justice, 211, 216, 221, 222, 224 ff.; on jurisdiction of international courts, 20; non-political character of functions, 347, 348; as organ of status quo, 3, 348; on unanimity, 369; and world public opinion, 197. *See also* International Court of Justice, International Courts  
 Peter the Great, and localized internationalism, 37  
 Petrie, Sir Charles, 481  
 Philippines, sovereignty, 252*n*  
 Phillimore, Sir Robert, 480  
 Phillips, Walter A., 487  
 Phillipson, Coleman, 222  
 Pitt, William, 7  
 Pluralism of loyalties, and peace, 392, 393  
 Poison gas, compliance with prohibition in Second World War, 329  
 Poland, partitions of, and balance of power, 135, 146, 147, 150, 165  
 Political disputes, as status quo vs. change,

## Index

- Political disputes (*continued*)  
342 ff.; different types, 344 ff. *See also*  
International conflicts, Tension
- Politics, Nicolas, 481
- Population, age distribution as element of  
national power, 94; quantity of, as  
element of national power, 91 ff., 135,  
152, 175 ff.; of Argentina, 94; Australia,  
92; British Empire, 93; Canada, 92;  
France, 92 ff.; Germany, 92 ff.; Great  
Britain, 93, 94; Latin America, 94, 115;  
Soviet Union, 92 ff.; United States, 92 ff.
- Population pressure, as justification for  
imperialism, 66
- Population trends, and future distribution  
of power, 93, 94, 110
- Portugal, and balance of power, 273; and  
British imperialism, 39; national morale,  
104
- Posony, Stefan T., 475, 485
- Potemkine, Vladimir, 481
- Potsdam, Agreement, 344, 345, 384; Con-  
ference, 69
- Potter, Pitman B., 487
- Pound, Roscoe, on international morality,  
189
- Power, political: American depreciation  
of, 19, 20; and authority, 142, concept,  
73; depreciation of, 15 ff., 38, 125, 426;  
depreciation of, as ideology, 66*n*; desire  
for, potentially unlimited, 36*n*, 155; and  
force, 13, 14; frustration and compensa-  
tion of individual drives for, 74 ff.;  
moral condemnation of, 62, 169, 170; as  
social pressure, 396; struggle for, 17,  
18, 21. *See also* Balance of power, In-  
ternational politics, Military force, Na-  
tional power
- Power politics, *see* Power, political
- Preparatory Commission for a Disarma-  
ment Conference (1925), 312, 321
- Prestige, in diplomatic negotiations, 432;  
nature of social, 50, 51, 56; as means  
and end of policy, 50, 55 ff.
- Prestige, policy of, 50 ff., 68, 346; and  
meeting places for conferences, 53, 54;  
neglect by Soviet Union and United  
States, 59, 60; of Soviet Union, 53
- Preventive War, 155, 156, 181
- Pribram, Karl, 480
- Prisoners of War, treatment, 179
- Private international law, 215
- Proudhon, on free trade as alternative to  
war, 16, 34
- Prussia, foreign policy, 278, 279. *See also*  
typical headings
- Public opinion, and national morale, 100,  
101; and nationalism, 201 ff.; and peace-  
ful change, 350 ff.
- Quadruple Alliance (November 20, 1815),  
361 ff.
- Racism, as mistaken evaluation of na-  
tional power, 118 ff.
- Radcliffe-Brown, A. R., 211*n*
- Rappard, William E., 488; on Switzerland  
as model for world state, 495
- Ratzel, Friedrich, 479
- Rauschnig, Hermann, 59*n*
- Raw materials, as element of national  
power, 83 ff.; importance since indus-  
trial revolution, 84; of Great Britain,  
84; Soviet Union, 84, 86; United States,  
84, 86
- Ray, Jean, 487; on interpretation of Cove-  
nant of the League of Nations, 217; on  
war under the Covenant, 374
- Réal de Curban, Gaspar de, 480
- Redlich, Marcellus D., 489
- Regional arrangements, as ideology, 64
- Reichstag of Ratisbone (1803), 270
- Reinsch, Paul S., 489
- Reinsurance Treaty between Germany  
and Russia (1887), 45, 46
- Religious Wars, and nationalistic univer-  
salism, 193 ff., 288, 291, 439, 440
- Reves, Emery, 488
- Revolution, popular: fear of, 21; obsoles-  
cent through modern technology, 299 ff.,  
353, 398. *See also* Coups d'état
- Richelieu, and balance of power, 134; and  
French power, 107
- Riches, Cromwell A., 483
- Rider, Fremont, 488
- Robbins, Lionel, 13*n*, 476
- Roberts, P. E., on Anglo-Russian imperi-  
alism concerning Iran, 39, 40
- Roman Empire, geographical limits, 298;  
based: on prestige, 57, on self-restraint,  
121; reasons for success, 298, 403; as  
symbol of unity of the world, 309
- Roman policy toward Carthage, moral  
significance of, 177
- Rommen, Hans, 475
- Roosevelt, Franklin D., 24, 25*n*, 62, 128,  
176; speech of December 2, 1939, against  
Russian air bombardment of Finnish ci-  
vilians, 182; as statesman, 108, 429
- Roosevelt, Theodore, 52, 121
- Roucek, Joseph S., 473
- Rousseau, Jean-Jacques, 309; on balance  
of power, 161; and international moral-  
ity, 195
- Rovigo, Duke of, 51
- Rucellai, on balance of power, 138
- Rules of conduct, conflicts among, 171,  
172, 191, 192. *See also* Ethics, Law,  
Morality, Mores

## Index

- Rumania, and French imperialism, 39  
Rush-Bagot Agreement (1817), 311, 313, 315  
Russell, Bertrand, 475  
Russell, Frank M., 474  
Russell, John (British statesman), on balance of power, 162; on unpredictability of foreign policy, 115  
Russia: geographical factors as sources of conflict with the West, 82; and Great Britain in nineteenth century, 271, 444; policy toward Turkey, 365, 366; policy on eve of First World War, 141, 142, 153, 156, 282; security belt and balance of power, 133. *See also* Soviet Union, topical headings  
Russo-Finnish War (1939-40), and air bombardment of civilians, 182; and decline of Russian prestige, 60  
Russo-Japanese War (1904-05), 279; economic objectives, 31  
Russo-Turkish War (1877), 279  
  
Saint-Pierre, Abbé de, 309  
Sanctions, importance for rules of conduct, 171, 172. *See also* Collective security, International law, International police force  
Saxe, Marshal of, on limited warfare, 288  
Schenk, H. G., 487  
Schindler, Dietrich, 482, 486  
Schmitt, Bernadotte E., 481  
Schultz, Theodore W., 484  
Schuman, Frederick L., 474  
Schumpeter, Joseph, 476, 477; on economic factor in imperialism, 322; on Marxian theories of imperialism, 34  
Schwarzenberger, Georg, 474, 482, 483; on codification of international law, 216  
Scott, James Brown, 3122  
Security, and disarmament, 317 ff.; French policy after First World War, 318, 319, 323, 332. *See also* Collective security, International police force  
Self-sufficiency in food, as element of national power, 82, 83  
Seton-Watson, Robert W., 1152, 481  
Seven Years' War (1756-1763), 158  
Sharp, Malcolm, 172  
Sharp, Walter R., 474, 488  
Shils, Edward A., 485  
Silberner, Edward, 475  
Simonds, Frank H., 474  
Small nations, defense of, as ideology, 64; and enforcement of international law, 229; and international courts, 225; their protection dependent on balance of power, 229; in United Nations, 241  
Smith, Charles W., 482  
Smith, J. Allen, on balance of power, 1272  
Socialism, illusion of international solidarity, 190  
Society, as a system of rules of conduct, 172. *See also* Peaceful change, World community, World state  
Sontag, Raymond J., 481  
Sorel, Albert, on Austrian balance of power, 147  
Souleyman, Elizabeth V., 485  
Sovereignty, 243 ff.; and Atomic Development Authority, 253 ff., 258; concept, 209, 210, 243, 244, 249, 259; of Cuba under Platt Amendment, 251, 252; obscured by democratic constitutions, 260, 261; divisibility of, as ideology, 261 ff.; and actual equality, 248; exercise of, political fact, 243, 250, 252, 259 ff., 413; in federal states, 261; in Great Britain, 2612; history, 209, 210, 243, 244; and immigration, 248; as "impenetrability," 245, 249, 253; and actual independence, 248; of Indian States, 250, 251; indivisibility, 250, 258 ff.; and actual interdependence, 248; and international courts, 256; and decentralized character of international law, 242 ff.; alleged incompatibility with international law, 244; protected by international law, 258, 267, 268; and American membership in League of Nations, 247, 256; location of, a matter of political judgment, 250, 252; loss of, 249 ff.; and majority rule, 256 ff.; and nationalism, 262, 263, 267 ff.; and international peace, 262; compatible with onerous peace treaties, 248; and American membership in Permanent Court of Justice, 247, 256; popular, 244; as quality of political control, 252, 257, 258; unaffected by quantity of legal restraints, 247, 252, 257, 258; temporary suspense, 250; synonyms, 245 ff.; in Third French Republic, 259, 2612; as argument for treaty revision, 248; and unequal representation, 256, 257; of members of United Nations, 255, 256, 382; of permanent members of United Nations Security Council, 255, 256; in United States, 250, 259 ff.; and veto, 247  
Soviet Union: policy toward China, 386, 387; and Communist International, 41; opposed to unification of Europe, 135; conception of foreign affairs, 429; and international law, 213, 215; policy toward Iran, 386; and the League of Nations, 377, 378; prestige, 60; public opinion with regard to United States, 205; as superpower, 271 ff., 284 ff.; policy

## Index

### Soviet Union (*continued*)

- toward Turkey, 385, 386; and UNESCO, 409; in United Nations Security Council, 433, 435; and United Nations specialized agencies, 414; points of friction with United States, 385 ff. *See also* Communist International, topical headings
- Spain: political decline and decline of agriculture, 83. *See also* topical headings
- Spanish-American War (1898), 9, 20; economic objectives, 31
- Spaulding, O. L., 484
- Speier, Hans, 484
- Spencer, Herbert, source of biological ideologies of imperialism, 65
- Spheres of influence, 39, 40, 135, 136
- "Splendid isolation," and balance of power, 143, 377
- Sprout, Harold and Margaret, 474
- Spykman, Nicholas, 476, 479, 480
- Staley, Eugene, 477, 479; forecast of range of aircraft, 297, 298; on myth of geographic unity of Western hemisphere, 118n
- Stalin, Joseph, 6, 53
- Stanhope, Lord (English statesman), 184
- Starke, J. G., 483
- State, concept, 396; and law enforcement, 395 ff.; as legal personality of nation, 396; modern, ability of moral compulsion, 192, 200, 201, 299, 301, 396; and peaceful change, 397. *See also* Peaceful change, Power, Revolution, Territorial state, World state
- State power, limits of its neutrality, 395, 396; and status quo, 395, 396; increased by modern technology, 299 ff. *See also* International police force, Power, Revolution, Technology, Totalitarianism, World state
- Status quo, policy of, 22 ff., 43 ff., 130 ff., 156 ff., 319 ff., 328, 332 ff., 342 ff.; and change, 24, 25, 27, 43, 46, 47; ideologies of, 63, 64, 158, 159, 318, 343; as defense of peace settlement, 22, 23, 142, 231, 318, 319 ff., 332, 361 ff., 371 ff.
- Stefansson, Vilhjalmur, 118n, 164n, 479
- Steiner, H. Arthur, 474
- Sternberg, Fritz, 477; on imperialism, 30n
- Stieglitz, Alexandre de, 480
- Stratton, George M., 482
- Strausz-Klupé, Robert, 476, 477, 479, 484
- Sturzo, Luigi, 478
- Submarine, influence upon distribution of power, 89, 91, 328; strategic importance for Germany, 317
- Sully, Duc de (French statesman), 309
- Sulzbach, Walter, 477, 478
- Sumner, William Graham, 4, 20, 28; on vices of diplomacy, 439, 443
- Sutherland, Justice, on sovereignty, 259
- Switzerland, economic policies, 48; as model for world state, 404, 405. *See also* Balance of power
- Tacitus, 96
- Taft, William Howard, 53
- Talleyrand, 185; and French power, 107
- Tank, influence upon distribution of power, 89
- Tannenbaum, Frank, 480
- Tate, Merze, 485
- Tawney, R. H., on balance of power, 163n; on militarism, 120, 121n
- Technology, modern: and American Civil War, 301, 302; characteristics, 301 ff.; of war and international morality, 192; mechanization of warfare, 292, 294 ff., 299 ff.; moral impact, 304, 305; and national power, 89, 90; and obsolescence of popular revolution, 299 ff.; of war, revolution in nineteenth and twentieth centuries, 294 ff., 438; and increase in state power, 299 ff.; and totalitarianism, 200, 201, 299 ff.; potential unification and actual fragmentation of the world through, 200 ff., 295 ff., 299 ff.; and feasibility of world empire, 299 ff. *See also* Atomic energy, Total war
- Teheran, Conference of, 69
- Temperley, Harold, 480, 481, 487
- Tension, concept, 343, 344; in national societies, 350 ff. *See also* International conflicts, International courts, Peaceful change, Political disputes, World state
- Territorial state, concept, 209, 210, 243
- Territory, as measure of national power, 151, 278
- Thiers, Louis Adolphe (French statesman), and balance of power, 162
- Thirty Years' War, and balance of power, 139, 150, 270; and nationalistic universalism, 195, 440
- Thompson, J. W., 481
- Thompson, Warren S., 479
- Timasheff, N. S., 481
- Titulescu, Nicholas (Rumanian statesman), 106, 370
- Tocqueville, Alexis de, 97
- Toenber, Irene B., 479
- Total war, general character, 287, 291 ff., 437; importance of civilians, 181, 182; and conscription, 289 ff.; and destructiveness of modern weapons, 296, 297; and international morality, 181 ff.; and total mechanization, 301 ff.; moral force, 305; conditioned by agricultural and



## Index

### Total war (*continued*)

- industrial productivity, 304. *See also* Technology, War, World War, First, and Second.
  - Totalitarianism: and national morale, 103, 104; and modern technology, 200, 201, 299 ff. *See also* National Socialism, Revolution, Soviet Union, World state
  - Toynbee, Arnold J., 480; on balance of power, 279
  - Trajan, and imperialism, 28
  - Treaties, *see* International law
  - Treaty of May 31, 1934, between United States and Cuba, 252
  - Trieste, status after Second World War, 384, 385
  - Triple Alliance among Germany, Austria, and Italy, 45, 46, 141, 405
  - Triple Entente between France, Russia, and Great Britain, 141
  - Troppau, Congress of (1820), 362
  - Truman Doctrine, 5, 6
  - Truman, Harry, 53
  - Turkey: American policy toward, 101, 130; and balance of power, 139, 141, 146; point of friction between United States and Soviet Union, 130, 385. *See also* Balance of power, major powers
- Unanimity, as synonym of sovereignty, 246, 247. *See also* League of Nations, Permanent Court of International Justice, Sovereignty, United Nations
- Unconditional surrender, moral significance, 182
- UNESCO, 211, 407 ff.; and the nature of international conflicts, 410, 411; Article I of Constitution, 407, 408; different functions, 408; and peace, 408 ff.; philosophy, 408, 409
- United Nations, 16, 194, 236 ff., 379 ff.; as alliance against superpower, 381; Armed Force, 256, 320, 321, 337, 339, 340, problem of composition, 339; Atomic Energy Commission, 311, 313, 317, 319 ff., 324; and collective security, 236 ff.; Commission for Conventional Armaments, 313, 323, 324; committees, 428; compared with League of Nations, 379, 380, 382, 383; Economic and Social Council, 412; and majority rule, 257; and fragmentation of international issues, 436, 437; as government by great powers, 379 ff.; as government by, not over, United States and Soviet Union, 381, 387; as ideology, 67, 68; and individual welfare, 412; and international law, 383; and interpretation of international law, 217*n*; legalism in settling

### United Nations (*continued*)

- international issues, 436, 437; Military Staff Committee, 339; organization, 379, 380; paralyzed by tension between United States and Soviet Union, 385 ff.; without political foundation, 383, 384; predicated upon unity of great powers, 381, 387; and peace, 309, 341; principles, 188; principles of justice, 382, 383; Purposes and Principles, 382, 383; Specialized Agencies: 412 ff., and the national interest, 414; as instrument of status quo, 68; and the undefined status quo, 383 ff.; and government of Trieste, 384, 385; Trusteeship Council and majority rule, 257; and war, 180, 381, 387; and world public opinion, 197, 198
- United Nations Charter, 211, 217, 219; Preamble, 382; Chapter I, 382; Chapter VI, 381, 383; Chapter VII, 236 ff., 381 ff.; Chapters IX and X, 412; Article 2: 246, 248, 382; Article 10: 379; Article 11: 312, 313, 379, 383; Article 12: 379; Article 13: 379; Article 14: 354 ff., 360, 379; Article 18: 257, 356; Article 23: 257; Article 24: 383; Article 25: 237; Article 26: 313; Article 27: 238 ff., 254, 255, 256 ff., 381; Article 39: 237, 240, 241, 256, 357, 359; Article 41: 237, 241, 255, 256, 357; Article 42: 237, 238, 241, 256, 337; Article 43: 237, 238, 256, 320, 340; Article 45: 237; Article 51: 238, 239, 241; Article 58: 412; Article 63: 412; Article 64, 412; Article 66: 412
- United Nations General Assembly, 226, 356 ff., 370, 379 ff.; impotence, 379, 380; and majority rule, 257; nature of recommendations, 356
- United Nations Security Council, 226, 237 ff., 357 ff., 379 ff.; ascendancy over General Assembly, 379, 380; compared with Holy Alliance, 380 ff.; and international police force, 339; and majority vote, 258; futility of majority vote, 433 ff.; conditions of its operation, 256; as enforcement agency for Atomic Development Authority, 254, 255; and unequal representation, 257; unanimity limited to permanent members, 379 ff.; predominant position of United States, 359, 435; veto, 239 ff., 254, 255, 257, 359, 381; veto as answer to majority vote, 435
- United States: adherence to compulsory jurisdiction of International Court of Justice, 222, 223; anti-militarism, 99; proposals for international control of atomic energy, 252 ff.; policy toward China, 23, 386, 387; policy toward Cuba, 251, 252; economic policies, 15; policy

## Index

### United States (*continued*)

toward Greece, 386; policy toward Iran, 386; isolation in nineteenth century, 19, 20; and the League of Nations, 375 ff., 383; and naval disarmament, 315 ff.; and the partition of Palestine, 358 ff.; and problem of international peace, 7, 8; continuity of policy, 5 ff.; policy toward Latin America, 22*n*, 37, 39, 54 ff.; policy favored by material conditions, 108; policy after Second World War, 69; discrepancy between actual and potential power, 99; public opinion and foreign policy, 101; nature of conflict with Soviet Union, 319 ff., 324, 339, 340, 344 ff., 348, 354, 412, 430; points of friction with Soviet Union, 385 ff.; conditions for peace with Soviet Union, 411; public opinion with regard to Soviet Union, 205; relations with Soviet Union and international understanding, 411; as superpower, 271 ff., 284 ff.; treaty with Prussia concerning treatment of prisoners of war (1785), 179; as model for world state, 405, 406. *See also* Good Neighbor policy, Monroe Doctrine, Open Door, Truman Doctrine, topical headings

*United States vs. Curtiss Wright Export Corporation*, on sovereignty, 259

Universal Postal Union, 211, 412, 414; and majority rule, 257; unequal representation, 256

UNNRA, 414

Upper Silesia, partition, 356*n*

Uranium, as element of national power, 86

Urban II, Pope, and imperialism, 32

Utrecht, Treaty of (1713), and balance of power, 135, 139

Vagts, Alfred, 476, 484

Valette, De la (French statesman), 165

Vattel, Emeric de, on balance of power, 161; on treaties of guaranty, 230

Venice, assassination as political instrument, 175; balance of power, 144; competition with Genoa, 52

Verona, Congress of (1822), 362

Versailles, Treaty of, 65, 99; and disarmament, 312, 329; and imperialism, 35; and defense of status quo, 318

Veto, *see* Atomic Development Authority, League of Nations, Sovereignty, United Nations Security Council

Victoria, Queen, and certainty in foreign affairs, 115

Vienna, Congress of, 135, 186; and codification of international law, 214

Vinacke, Harold M., 487

Viner, Jacob, 477, 484; on economic theories of imperialism, 33

Virgin Islands, acquisition of, by United States, 25, 26

Voltaire, 96, 195

Walsh, Edmund A., 474

War, civilian losses, 293, 294; limited by climate, 299, 300; universal, result of collective security, 334 ff.; and commercial classes, 310; as competition of princes, 184; moral condemnation of, 180, 181; as contest between armed forces, 178 ff.; as contest between whole populations, 178, 292, 293; co-existent with cultural unity, 410; as instrument of foreign policy, 14, 15, 289; moral identification with, 289 ff.; doctrine of just, 289; limited, 287 ff.; limited, British variety of, 291*n*; localized, and collective security, 334 ff.; influence of mechanization upon, 292, 294 ff., 301 ff.; military losses, 293, 294; attributed to misunderstanding, 411; and non-combatants, 178 ff., 292 ff.; political objective of, 15; belief in obsolescence, 310; universal opposition to, determined by nationalism, 203 ff.; preventive, 99; analogy with revolution, 352, 353; influence of size of armies upon, 292, 293, 301, 302. *See also* Holy Alliance, League of Nations, Military policy, Revolution, Technology, Total war, United Nations War, Civil, conditions for outbreak, 398, 401, 403. *See also* Revolution

War of the First Coalition (1792-97), 185

War of the Spanish Succession, 135, 145

Washington's Farewell Address, 5, 6, 19, 108, 139

Washington Treaty for the Limitation of Naval Armaments (1922), 137, 311, 313 ff., 325, 326

Webster, Charles K., 474, 481, 487

Weigert, Hans W., 118*n*, 164*n*, 479

Welles, Sumner, 484

Wellington, Duke of, on quality of armies in Napoleonic Wars, 290

Weldon, T. D., 481

West, Ranyard, 481

West, Rebecca, 478

Western civilization, restraining influence on struggle for power, 160 ff., 169 ff. *See also* Morality

*Western Maid, The*, on sovereignty, 250*n*

Westlake, John, on international morality, 183

Westphalia, Treaty of, 210, 278

Wheeler-Bennett, John, 485

## Index

- White supremacy over colored races, mistaken belief in permanency, 115
- Whittlesey, Derwent, 479
- Wight, Martin, 476
- Wild, Payson S., 485
- William III of England, and balance of power, 145
- William II of Germany, 5, 6, 45, 46, 96, 100, 271; and international aristocracy, 189, 190; and continental imperialism, 37, 38, 68; policy of prestige, 55, 56; and Spanish-American War, 190; visit to Tangier (1905), 55
- Williams, Sir John Fischer, 483
- Willits, Joseph H., 489
- Wilson, James, on sovereignty, 260
- Wilson, Woodrow, 13, 16, 67; on diplomacy, 427; Fourteen Points, 63, 202, 203; and national self-determination, 165; as statesman, 108; and nationalistic universalism, 194; and world public opinion, 202, 203
- Windelband, Wolfgang, 481
- Winslow, E. M., 477
- Wirth, Louis, 478
- Wolfers, Arnold, 481, 487
- Wolsey, Cardinal, and balance of power, 96; influence on British power, 106
- Woodward, E. L., 484, 485
- Woolf, L. S., 487
- World community, 406 ff.; how to create, 413; and culture, 408, 409; and cultural interchange, 408 ff.; and education, 408 ff.; functional approach to, 412 ff.; and international contacts, 408 ff.; and international understanding, 408, 410 ff.; general nature, 412; and peace, 444; its creation a political problem, 415; dependent upon moral and political revolution, 400, 409; and supranational loyalties, 413, 414; and UNESCO, 407 ff.
- World conquest, *see* Imperialism, World empire, World state
- World Disarmament Conference (1932), 311, 312, 316 ff., 321 ff., 327 ff.
- World empire, 36, 298 ff., 304, 305, 403, 404; prevented by balance of power, 137 ff., 150; causes for downfall, 298, 403; geographical expansion, 298; technological conditions, 298 ff., 304, 305; technological feasibility, 299 ff. *See also* individual empires, World state
- World Health Organization, 412, 414
- World public opinion, 197 ff.; concept, 198; and divergencies in moral and political judgments and aspirations, 199, 200; ineffectiveness in period between World Wars, 198; misconceptions, 198, 199, 206; and international morality,
- World public opinion (*continued*)  
198 ff., 205, 206; and Italo-Ethiopian War, 204; and responsibility for Second World War, 204, 205; and technological unification, 200 ff.; and psychological unity of mankind, 199; and nationalistic universalism, 206, 267; and war, 203 ff.; and Wilson's Fourteen Points, 202, 203
- World state, 391 ff.; problem of its creation, 399 ff.; its creation a political problem, 419; test for its feasibility, 400 ff.; and immigration, 402; and international police force, 340; and interstate trade, 402; moral problem, 400, 401; and the national interest, 400 ff.; and nationalism, 400 ff.; and parliamentary institutions, 401; and peace, 341, 391; and problem of representation, 401; and totalitarianism, 404; and world community, 400, 402, 405 ff.; through world conquest, 403, 404. *See also* World community, World empire
- World War, First: and balance of power, 140 ff., 148, 149, 153, 154, 165, 270 ff., 282; German predicament, 107; influence of military preparedness upon, 89 ff.; policies leading toward, 24, 45, 46, 136, 141, 142, 153 ff., 180, 282; caused by fear of population trend, 93; as preventive war, 155, 156; as total war, 182, 292 ff.; and nationalistic universalism, 194, 195. *See also* major powers, topical headings
- World War, Second: and balance of power, 140, 148, 149, 153, 156, 157, 165, 271 ff.; German predicament, 107, 108; policies leading toward, 180, 181; influence of military preparedness upon, 89 ff.; British and French policy toward Soviet Union, 436; as total war, 182, 183, 292; and nationalistic universalism, 194. *See also* major powers and topical headings
- World Wars, and economic objectives, 31; and problem of food, 82, 83; and modern nationalism, 76
- Wolton, Sir Henry, 184; on diplomacy, 426
- Wright, J. W., 484
- Wright, Quincy, 474, 488; on balance of power, 164; on costliness of civil wars, 398; on ratio of civil and international wars, 397, 398
- Wynner, Edith, 485
- Yalta, Declaration of, 69, 194, 384, 386
- Young, George, 489
- Zimmern, Sir Alfred E., 487

## PRINTER'S NOTE

*This book was set on the Linotype in GRANJON, a type named in compliment to Robert Granjon, type-cutter and printer — 1523–1590, Antwerp, Lyons, Rome, Paris. Granjon, the boldest and most original designer of his time, was one of the first to practice the trade of type-founder apart from that of printer.*

*Linotype GRANJON was designed by George W. Jones, who based his drawings upon a face used by Claude Garamond (1510–1561) in his beautiful French books. GRANJON more closely resembles Garamond's own type than do any of the various modern faces that bear his name.*

*The book was composed, printed, and bound by The Plimpton Press, Norwood, Massachusetts.*